

**SICOM3000S Series**  
**Industrial Ethernet Switch**  
**Web Operation Manual**

Publication Date: Apr. 2023

Version: V1.0

***KYLAND***

**Disclaimer:**

Kyland Technology Co., Ltd. tries to keep the content in this manual as accurate and as up-to-date as possible. This document is not guaranteed to be error-free, and we reserve the right to amend it without notice.

**All rights reserved**

No part of this documentation may be excerpted, reproduced, translated, annotated or duplicated, in any form or by any means without the prior written permission of KYLAND Corporation.

**Copyright © 2023 Kyland Technology Co., Ltd.**

Website: <http://www.kyland.com>

FAX: +86-10-88796678

Email: [services@kyland.com.cn](mailto:services@kyland.com.cn)

# Contents

Introduction.....	1
1 Product Introduction.....	5
1.1 Overview.....	5
1.2 Software Features.....	5
2 Switch Access.....	6
2.1 View Types.....	6
2.2 Switch Access by Console Port.....	7
2.3 Switch Access by Telnet.....	10
2.4 Switch Access by Web.....	11
3 User.....	14
3.1 User management.....	14
3.1.1 Introduce.....	14
3.1.2 Web Configuration.....	14
3.2 Auth Type.....	17
4 System.....	19
4.1 Basic Information.....	19
4.2 Config Management.....	19
4.3 Clock management.....	24
4.4 Software update.....	29
4.4.1 Local update.....	29
4.4.2 FTP upgrade.....	31
4.4.3 TFTP upgrade.....	35
4.5 Restart.....	37
4.6 Abort.....	38
5 Service.....	39
5.1 SSL Configuration.....	39
5.1.1 Introduce.....	39
5.1.2 Web Configuration.....	39

5.2 SNMP v1/SNMP v2c .....	41
5.2.1 Introduction.....	41
5.2.2 Implementation .....	41
5.2.3 Explanation.....	41
5.2.4 MIB Introduction .....	42
5.2.5 Web Configuration.....	43
5.2.6 Typical Configuration Example .....	48
5.3 SNMPv3.....	49
5.3.1 Introduce.....	49
5.3.2 Implementation .....	50
5.3.3 Web Configuration.....	50
5.3.4 Typical Configuration Example .....	60
5.4 SSH Configuration .....	62
5.4.1 Introduction.....	62
5.4.2 Implementation .....	62
5.4.3 Web Configuration.....	62
5.4.4 Typical Configuration Example .....	63
5.5 TACACS+ Configuration .....	66
5.5.1 Introduction.....	66
5.5.2 Web Configuration.....	66
5.5.3 Typical Configuration Example .....	68
5.6 RADIUS Configuration .....	68
5.6.1 Introduction.....	68
5.6.2 Web Configuration.....	69
5.6.3 Typical Configuration Example .....	72
5.7 RMON .....	73
5.7.1 Introduce.....	73
5.7.2 RMON Groups.....	74
5.7.3 Web Configuration.....	75
6 Alarm .....	81

6.1 Introduction .....	81
6.2 Web Configuration .....	81
7 Function Management .....	88
7.1 Port Configuration .....	88
7.2 VLAN.....	95
7.2.1 VLAN Configuration.....	95
7.2.2 GVRP .....	103
7.2.3 VLAN STATUS.....	107
7.3 IP Configuration .....	108
7.3.1 IP Address Configuration .....	108
7.4 Port Aggregation .....	114
7.4.1 Static Aggregation.....	114
7.4.2 LACP .....	116
7.5 Redundancy .....	122
7.5.1 DT-Ring .....	122
7.5.2 DRP .....	131
7.5.3 DHP .....	138
7.5.4 RSTP/STP Configuration.....	146
7.5.5 MSTP Configuration .....	156
7.6 ARP Configuration.....	175
7.6.1 Introduction.....	175
7.6.2 Description.....	176
7.6.3 Proxy ARP .....	176
7.6.4 Web Configuration.....	177
7.7 ACL Configuration .....	179
7.7.1 Overview.....	179
7.7.2 Implementation .....	179
7.7.3 Web Page configuration .....	180
7.8 MAC Address Configuration .....	185
7.8.1 Introduction.....	185

7.8.2 Web Configuration .....	185
7.9 PoE .....	189
7.9.1 Introduce.....	189
7.9.2 Web Configuration .....	190
7.9.3 Typical Application Example .....	192
7.10 IGMP Snooping.....	192
7.10.1 Introduction.....	192
7.10.2 Basic Concepts.....	193
7.10.3 Principle.....	194
7.10.4 Web Configuration .....	194
7.10.5 Typical Application Example .....	200
7.11 DHCP Configuration .....	201
7.11.1 DHCP Server Configuration.....	203
7.11.2 DHCP Snooping.....	213
7.11.3 DHCP Relay.....	217
7.12 IEEE802.1X Configuration .....	222
7.12.1 Introduction.....	222
7.12.2 Web Configuration .....	222
7.12.3 Typical Configuration Example .....	231
7.13 GMRP .....	232
7.13.1 GARP Introduction.....	232
7.13.2 GMRP Protocol.....	233
7.13.3 Explanation.....	234
7.13.4 Web Configuration .....	234
7.13.5 Typical Configuration Example .....	237
7.14 Route configuration .....	239
7.14.1 Routing Table.....	239
7.15 QoS Configuration.....	242
7.15.1 Introduction.....	242
7.15.2 Principle.....	243

7.15.3 Web Page configuration .....	244
7.15.4 Typical Configuration Example .....	255
8 Loop Detect Configuration .....	258
8.1 Overview .....	258
8.2 Web Configuration .....	258
8.3 Typical Configuration Example .....	261
9 Diagnosis .....	263
9.1 Log .....	263
9.1.1 Introduction .....	263
9.1.2 Web Configuration .....	263
9.2 Port Mirror .....	266
9.2.1 Introduction .....	266
9.2.2 Explanation .....	266
9.2.3 Web Configuration .....	267
9.2.4 Typical Configuration Example .....	269
9.3 LLDP .....	269
9.3.1 Introduction .....	269
9.3.2 Web Configuration .....	270
9.4 Trace Route .....	272
9.5 Ping .....	274
9.6 IP Source Guard .....	275
9.6.1 Introduce .....	275
9.6.2 Principle .....	276
8.6.3 Web Configuration .....	276
8.6.4 Typical Configuration Example .....	279
9.7 DDM .....	281
9.7.1 Introduce .....	281
9.7.2 Web Configuration .....	281
Appendix: Acronyms .....	283

## Introduction

This manual mainly introduces the access methods and software features of SICOM3000S industrial Ethernet switch, and details Web configuration methods.

## Content Structures

The manual contains the following contents:

Main Content	Explanation
1. Product Introduction	<ul style="list-style-type: none"> <li>➤ Overview</li> <li>➤ Software Features</li> </ul>
2. Switch Access	<ul style="list-style-type: none"> <li>➤ View Types</li> <li>➤ Switch Access by Console Port</li> <li>➤ Switch Access by Telnet</li> <li>➤ Switch Access by Web</li> </ul>
3. User	<ul style="list-style-type: none"> <li>➤ User Management</li> <li>➤ Auth Type</li> </ul>
4. System	<ul style="list-style-type: none"> <li>➤ Basic information</li> <li>➤ Config Management</li> <li>➤ Clock management</li> <li>➤ Software update (HTTP, FTP, TFTP)</li> <li>➤ Soft Application Active</li> <li>➤ Language Update</li> <li>➤ Restart</li> <li>➤ About</li> </ul>
5. Service	<ul style="list-style-type: none"> <li>➤ SSL Configuration</li> <li>➤ SNMP v1/v2c/v3</li> <li>➤ SSH Configuration</li> <li>➤ TACACS+ Configuration</li> <li>➤ RADIUS Configuration</li> <li>➤ DNS</li> </ul>



	<ul style="list-style-type: none"> <li>➤ RMON</li> </ul>
6. Alarm	
7. Function Management	<ul style="list-style-type: none"> <li>➤ Port Configuration</li> <li>➤ VLAN</li> <li>➤ IP Configuration</li> <li>➤ Port Aggregation</li> <li>➤ Redundancy</li> <li>➤ ARP Configuration</li> <li>➤ ACL Configuration</li> <li>➤ MAC Address Configuration</li> <li>➤ POE</li> <li>➤ IGMP snooping</li> <li>➤ DHCP Configuration</li> <li>➤ IEEE802.1X Configuration</li> <li>➤ GMRP</li> <li>➤ Static Route</li> <li>➤ QoS Configuration</li> </ul>
8. Loop Detect Configuration	<ul style="list-style-type: none"> <li>➤ Loop Detect Configuration</li> </ul>
9. Diagnosis	<ul style="list-style-type: none"> <li>➤ Log</li> <li>➤ Port Mirror</li> <li>➤ LLDP</li> <li>➤ Trace Route</li> <li>➤ Ping</li> <li>➤ IP Source Guard</li> <li>➤ DDM</li> </ul>

## Conventions in the manual

### 1. Text format conventions



Format	Explanation
< >	The content in < > is a button name. For example, click <Apply> button.

[ ]	The content in [ ] is a window name or a menu name. For example, click [File] menu item.
{ }	The content in { } is a portfolio. For example, {IP address, MAC address} means IP address and MAC address is a portfolio and they can be configured and displayed together.
→	Multi-level menus are separated by “→”. For example, Start → All Programs → Accessories. Click [Start] menu, click the sub menu [All programs], then click the submenu [Accessories].
/	Select one option from two or more options that are separated by “/”. For example “Addition/Deduction” means addition or deduction.
~	It means a range. For example, “1~255” means the range from 1 to 255.

## 2. CLI conventions

Format	Description
<b>Bold</b>	Commands and keywords, for example, <b>show version</b> , appear in <b>bold</b> font.
<i>Italic</i>	Parameters for which you supply values are in <i>italic</i> font. For example, in the <b>show vlan</b> <i>vlan id</i> command, you need to supply the actual value of <i>vlan id</i> .

## 3. Symbol conventions

Symbol	Explanation
 <b>Caution</b>	The matters need attention during the operation and configuration, and they are supplement to the operation description.
 <b>Note</b>	Necessary explanations to the operation description.
 <b>Warning</b>	The matters call for special attention. Incorrect operation might cause data loss or damage to devices.

## Product Documents

The documents of SICOM3000S industrial Ethernet switch include:

Name of Document	Content Introduction
SICOM3000S Series Industrial Ethernet Switches	Describes the hardware structure, hardware

Hardware Installation Manual_V1.0.pdf	specifications, mounting and dismounting methods.
SICOM3000S Industrial Ethernet Switch Web Operation Manual	Describes the switch software functions, Web configuration methods, and steps of all functions.

## **Document Obtainment**

Product documents can be obtained by:

➤ Kyland website: [www.kyland.com](http://www.kyland.com)

# 1 Product Introduction

## 1.1 Overview

SICOM3000S includes a series of high-performance industrial Ethernet switches developed by Kyland particularly for rail transportation industry. The series devices meet the requirements stipulated in the EN50155, EN50121 and other industrial standards. The switches support MSTP/RSTP, IEC62439-6 redundancy protocols, guaranteeing the reliable operation of the system.

## 1.2 Software Features

SICOM3000S provides abundant software features, satisfying customers' various requirements.

- Redundancy protocols: DRP, STP/RSTP and MSTP.
- Multicast protocols: IGMP Snooping, GMRP.
- Switching attributes: VLAN, GVRP, QoS, and ARP.
- Bandwidth management: port static aggregation, LACP.
- Security: user management, access management, SSH, SSL, TACACS+, RADIUS, IEEE802.1X, ACL, IP Source Guard.
- Synchronization protocols: SNTP, NTP.
- Device management: software update, configuration file upload/download, and log record and upload.
- Device diagnosis: port mirror, LLDP.
- Alarm function: power alarm, port alarm, ring alarm.
- Network management: management by CLI, Telnet, Web and Kyvision network management software, DHCP, and SNMP v1/v2c/v3 network monitoring.
- .....

## 2 Switch Access

You can access the switch by:

- Console port
- Telnet/SSH
- Web browser
- Kyvision management software

Kyvision network management software is designed by Kyland. For details, refer to its user manual.

### 2.1 View Types

When logging into the Command Line Interface (CLI) by the console port or Telnet, you can enter different views or switch between views by using the following commands.

Table 1 View Types

View Prompt	View Type	View Function	Command for View Switching
SWITCH #	Privileged mode	View recently used commands. View software version. View response information for ping operation. Upload/Download configuration file. Restore Default configuration. Reboot switch. Save current configuration. Display current configuration. Update software.	Input “ <b>configure terminal</b> ” to switch from privileged mode to configuration mode.  Input “ <b>exit</b> ” to return to the general mode.
SWITCH (config) #	Configuration mode	Configure all switch functions.	Input “ <b>exit</b> ” or “ <b>end</b> ” to return to the Privileged mode.

When the switch is configured through the CLI, "?" can be used to get command help. In the help information, there are different parameter description formats. For example, <1, 255>

means a number range; <xx:xx:xx:xx:xx:xx> means a MAC address; <word31> means the string range is 1~31. In addition, ↑ and ↓ can be used to scroll through recently used commands.

## 2.2 Switch Access by Console Port

You can access a switch by its console port and the hyper terminal of Windows OS or other software that supports serial port connection, such as HTT3.3. The following example shows how to use Hyper Terminal to access switch by console port.

1. Connect the serial port of a PC to the console port of the switch with a DB9-RJ45 cable.
2. Run the Hyper Terminal in Windows desktop. Click [Start] → [All Programs] → [Accessories] → [Communications] → [Hyper Terminal], as shown in Figure 1.

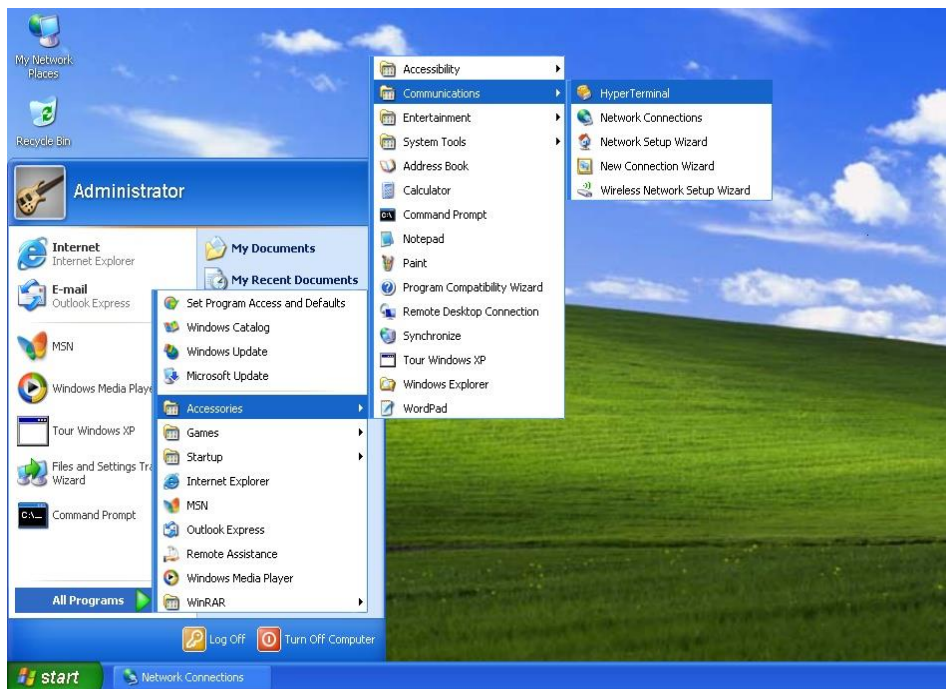

Figure 1 Starting the Hyper Terminal

3. Create a new connection "Switch", as shown in Figure 2.

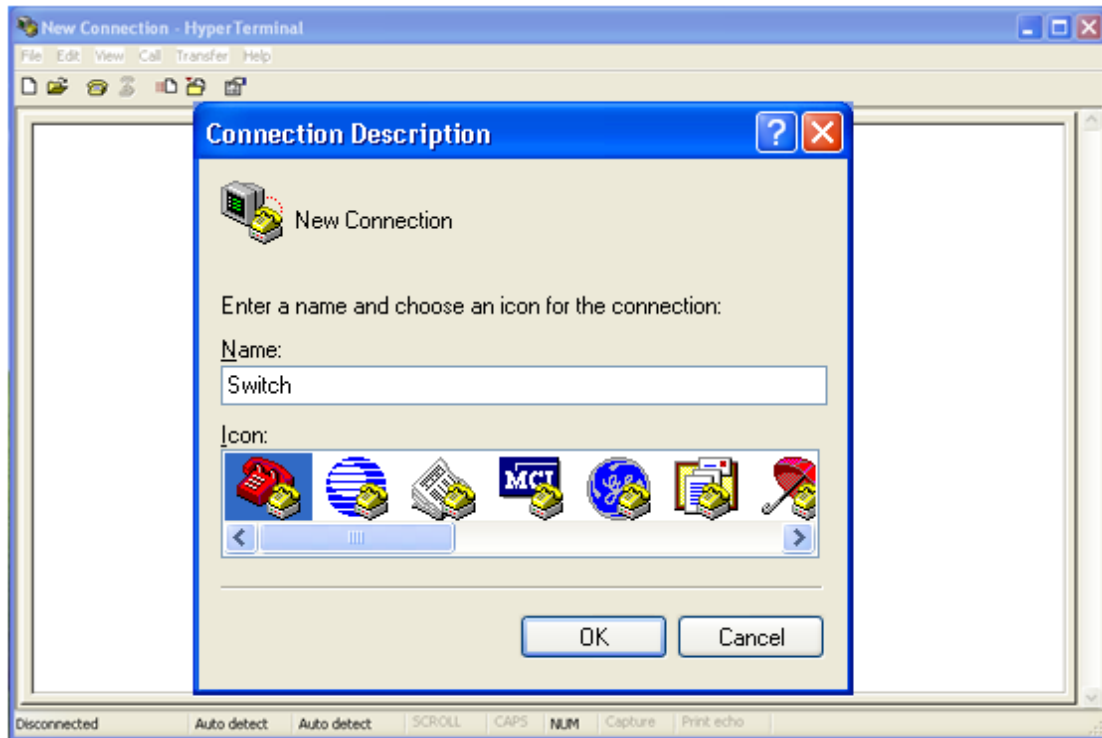

Figure 2 Creating a New Connection

4. Connect the communication port in use, as shown in Figure 3.

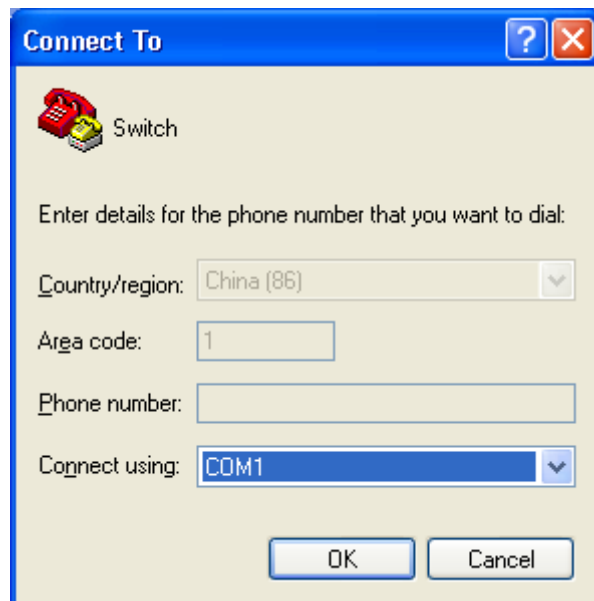

Figure 3 Selecting the Communication Port



**Note:**

To confirm the communication port in use, right-click [My Computer] and click [Property] → [Hardware] → [Device Manager] → [Port].

5. Set port parameters (Bits per second: 115200, Data bits: 8, Parity: None, Stop bits: 1, and Flow control: None), as shown in Figure 4.

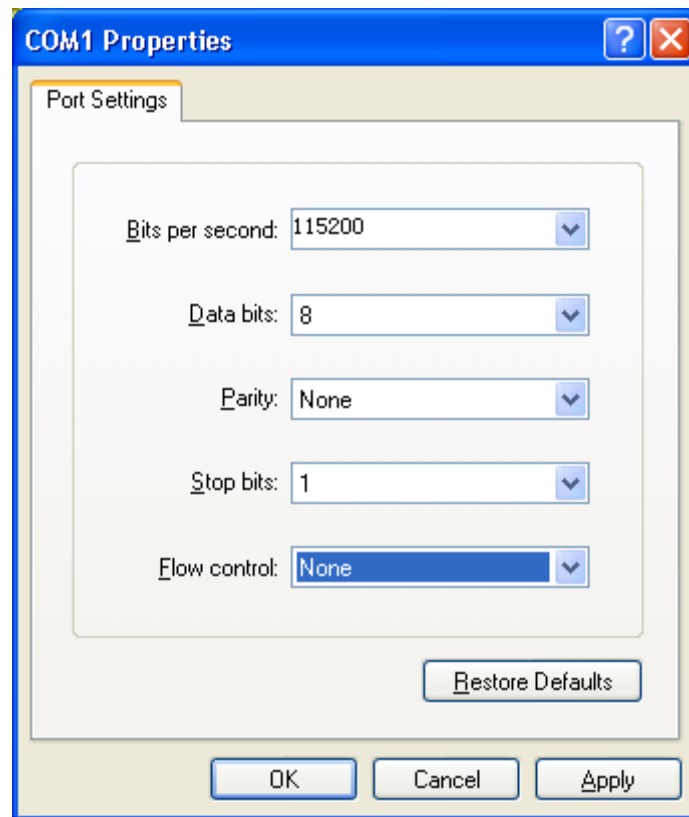

Figure 4 Setting Port Parameters

6. Click <OK> button to enter the switch CLI. Input default user "admin", and password "123" to enter the privileged mode. You can also input other created users and password, as shown in Figure 5.



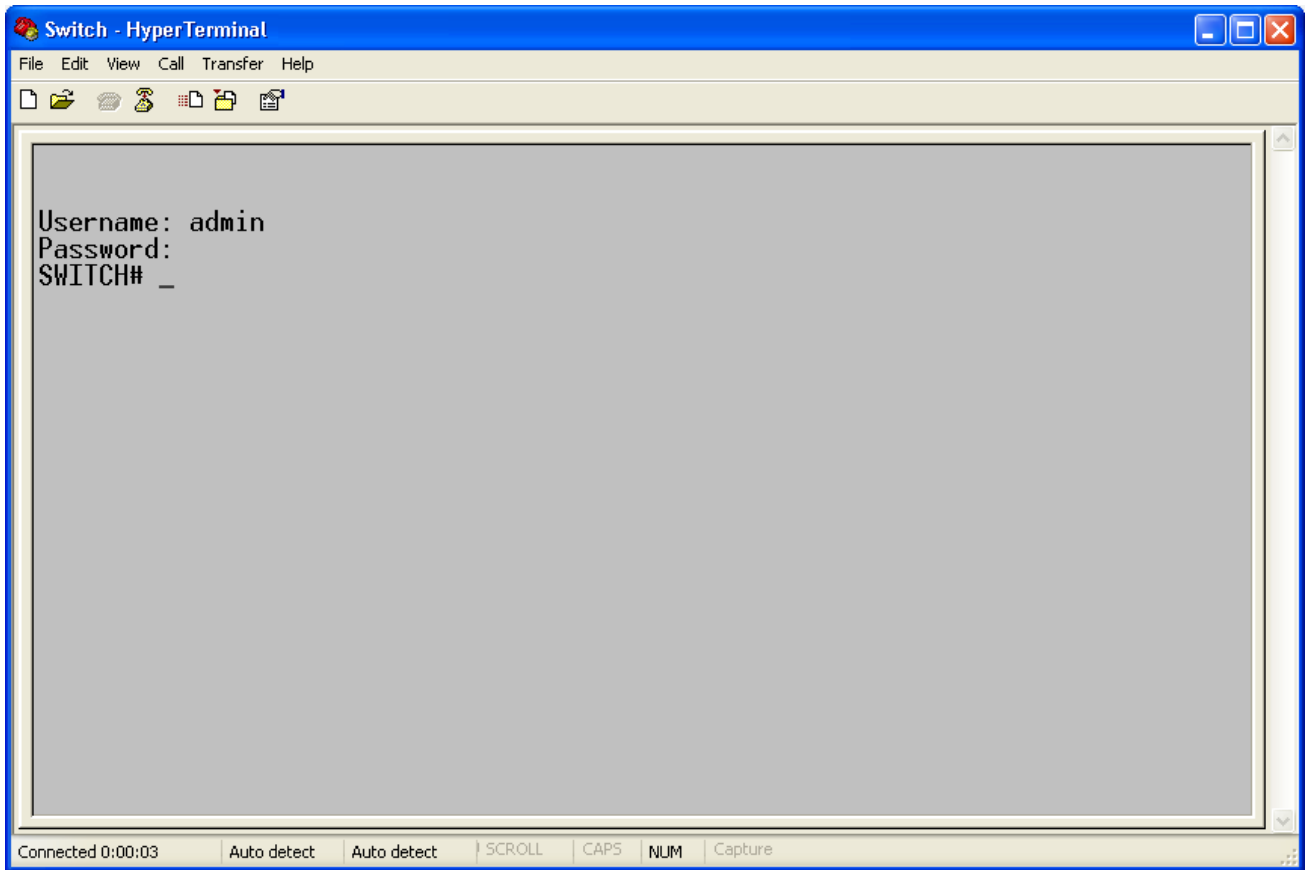

Figure 5 CLI

### 2.3 Switch Access by Telnet

The precondition for accessing a switch by Telnet is the normal communication between the PC and the switch.

1. Enter "**telnet** *IP address*" in the Run dialog box, as shown in Figure 6. The default IP address of a Kyland switch is 192.168.0.2.

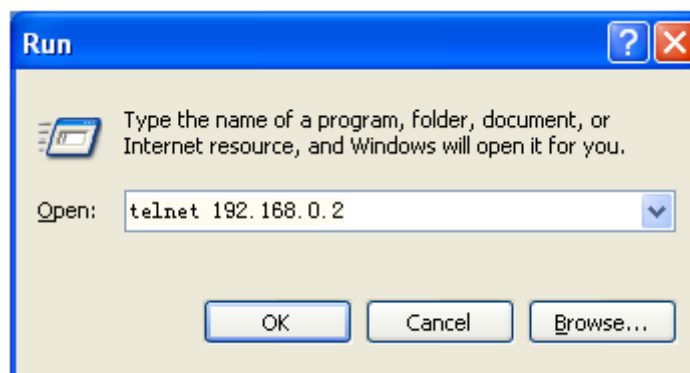

Figure 6 Telnet Access

**Note:**

To confirm the switch IP address, please refer to “7.3 IP Configuration” to learn how to obtain IP address.

2. In the Telnet interface, input user "admin", and password "123" to log in to the switch. You can also input other created users and password, as shown in Figure 7.

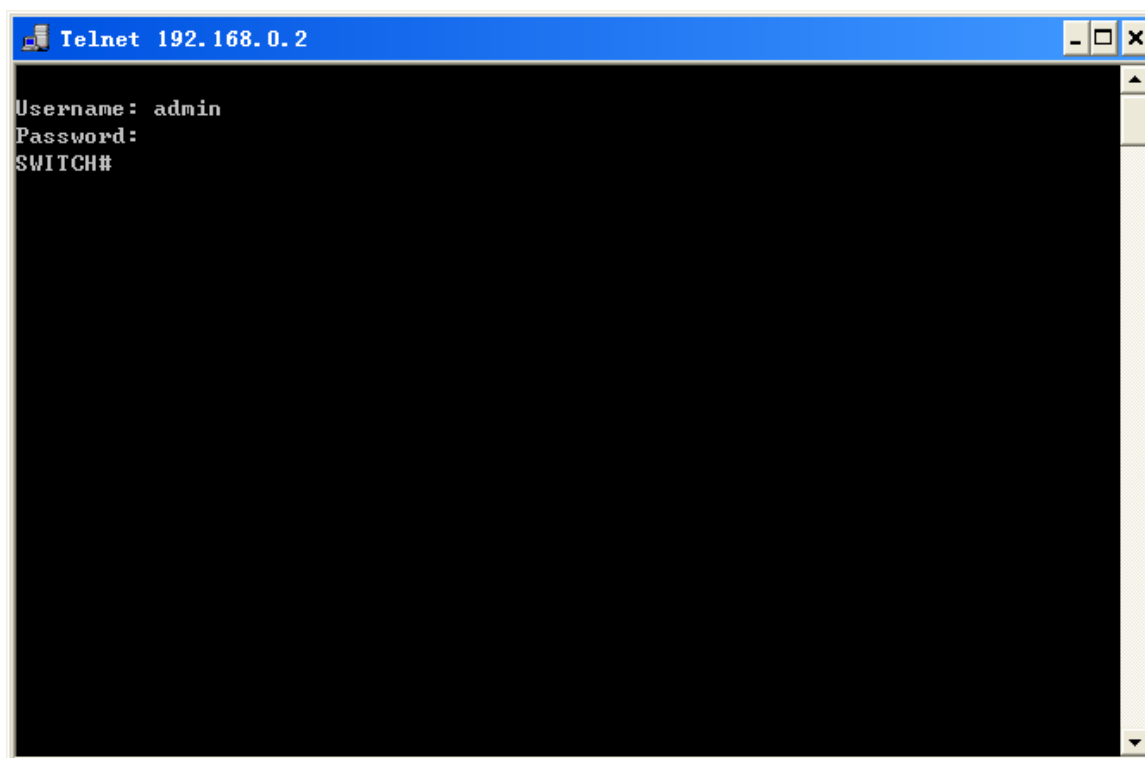

Figure 7 Telnet Interface

## 2.4 Switch Access by Web

The precondition for accessing a switch by Web is the normal communication between the PC and the switch.

**Note:**

IE8.0 or a later version is recommended for the best Web display results.

1. Input "*IP address*" in the browser address bar. The login interface is displayed, as shown in Figure 8. Input the default user name "admin", password "123", and the Verification. Click <Login>. You can also input other created users and password.

A screenshot of a web login dialog box. The title is "Sign in". Below the title, the URL "http://192.168.0.2" is displayed, followed by the warning "Your connection to this site is not private". There are two input fields: "Username" with the text "admin" and "Password" with three dots. At the bottom, there are two buttons: a blue "Sign in" button and a white "Cancel" button with a blue border.

Figure 8 Web Login

Enter the main interface. In the upper right corner, you can switch to the English or Chinese Web operation interface. The English login interface is displayed by default.

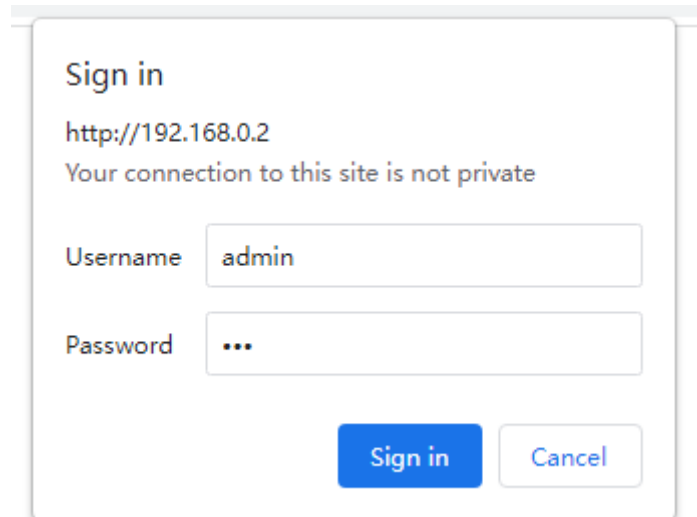

**Note:**

To confirm the switch IP address, please refer to “7.3 IP Configuration” to learn how to obtain IP address.

2. After you log in successfully, there is a navigation tree on the left of the interface, as shown in Figure 9.



Figure 9 Web Interface

You can expand or collapse the navigation tree by clicking menu on the navigation tree. You

can click [Home](#) to link to Figure 9, and click  to exit the Web interface.

### 3 User

#### 3.1 User management

##### 3.1.1 Introduce

To solve the security problem caused by illegal user access switch, the switch provides the function of user hierarchical management, based on different user identity, set different permissions to meet the diversify of user permissions control.

##### 3.1.2 Web Configuration

1. Create a new user, as shown below.

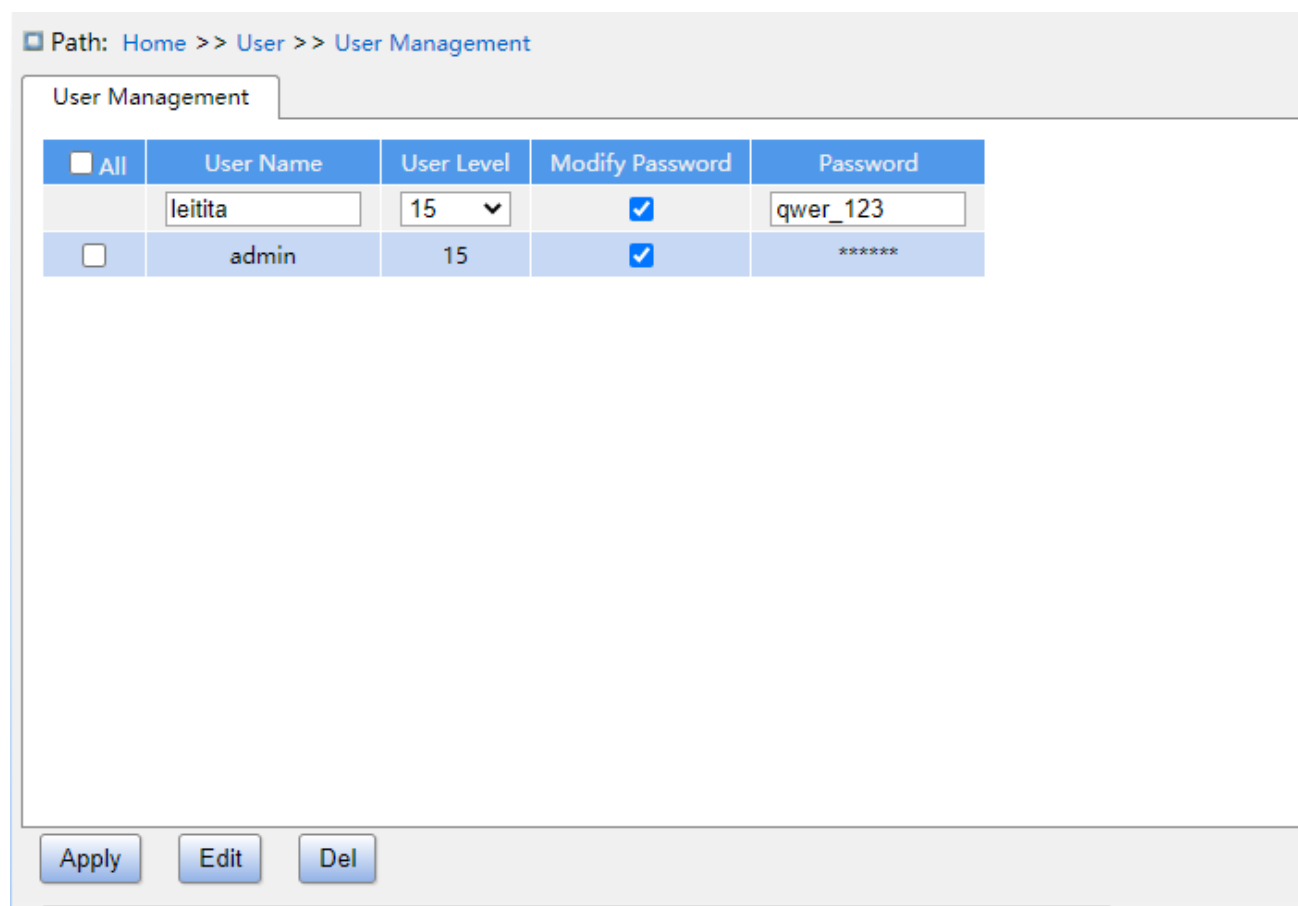

Figure 10 Create a new user

Add a new user in the user name formula bar, configure different user levels, and max 20 users can be created.

#### User name

Configuration range: 1~31 characters

Function: configure user name.

**User level**

Configuration range: 0~15

Function: Configure the user's permission level. Users with different permission levels have different access permissions.

**Password**

Configuration range: 0~31 characters

Function: configure user login password.

2. Edit user configuration, as shown below.

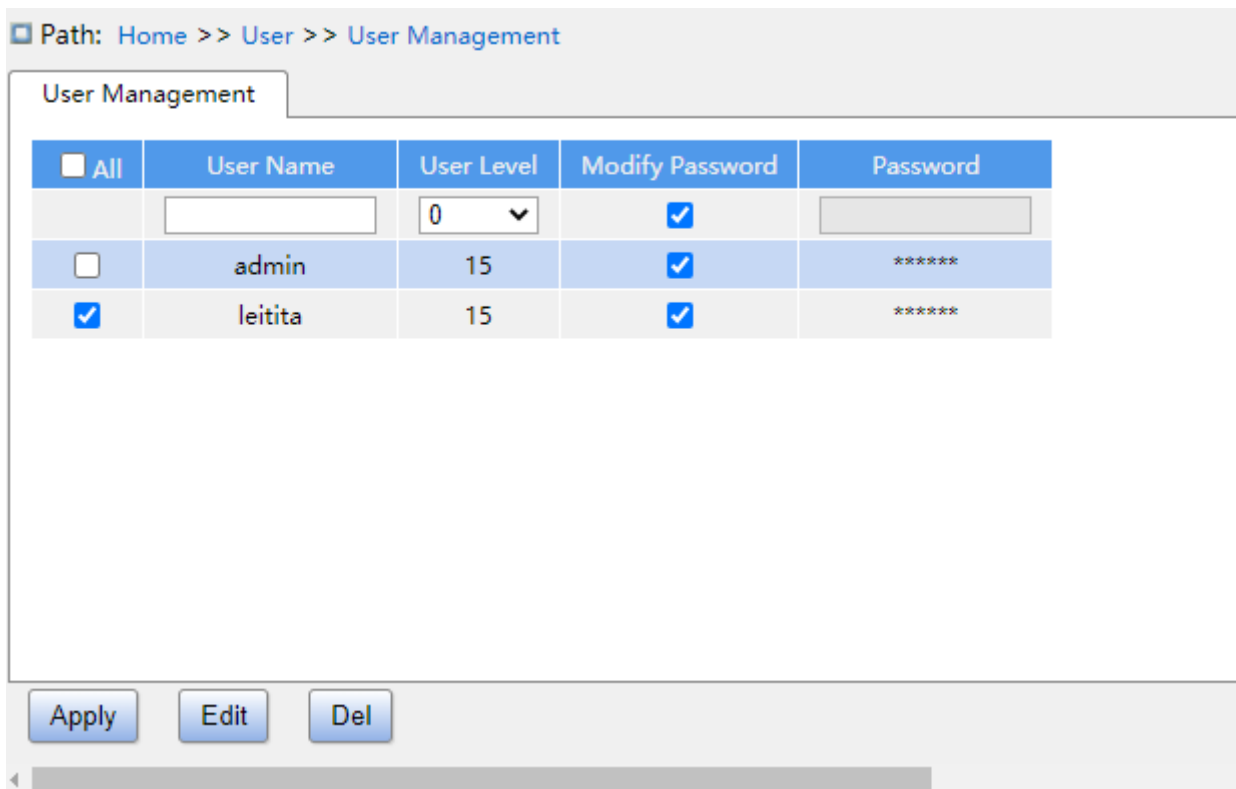

Figure 11 Edit user configuration

Check the user who needs to be edited, click <Edit> button to modify the password and permission levels of user.

Click <Del> button to delete the current user.



**Note:**

- The default user admin can't be deleted:

3. Configure groups privilege level, as shown below.

Path: Home >> User >> Access Configuration

Access Configuration

Group Name	Read Level	Config Level
*	0	0
System Information	10	10
Config Management	10	10
Set Time	5	10
NTP	5	10
SNTP	5	10
PTP	5	10
Firmware	15	15
Language Update	10	10
Reboot	10	10
HTTPS	5	10
SNMP	5	10
SSH	5	10
TACACS+	5	10
RADIUS	5	10
DNS	5	10
RMON Configuration	5	10
RMON Status	5	0
Alarm	5	10
Port Configuration	5	10
Port Statistics	0	10
VLAN	5	10
IP Configuration	5	10
Static Association	5	10

Apply

Figure 12 Configure groups privilege level

**Group Name**

Configuration options: All functional groups

Function: Select the switch function group for the operation

**Read Level**

Configuration options: 0-15

Default configuration: 5

Function: Configure the level at which the current function group can be viewed by the user. Different levels of function groups have different permission level requirements for user viewing.

**Config Level**

Configuration options: 0-15

Default configuration: 10

Function: Configure the level at which the current function group can be operated by the user. Different levels of function groups have different permission level requirements for user operations.



**Note:**

When the user privilege level is same or greater than a group privilege level, the user can access or configure the group. The access or configure right is based on the user privilege level.

**3.2 Auth Type**

Configure access mode to switch, authentication mode and authentication order, as shown below.

Path: Home >> User >> Auth Type

Auth Type

Service Type	Authentication 1	Authentication 2	Authentication 3
Web	Local	--	--
Console	Local	--	--
Telnet	Local	--	--
SSH	Local	--	--

Figure 13 Authentication Login Configuration

**Service Type**

Configuration options: Web/Console/Telnet/SSH

Function: Select access mode to switch.

**Authentication1/ Authentication2/ Authentication3**



Configuration options: --/local/tacacs/radius

Default configuration: local

Function: The methods from left to right are Authentication1, Authentication2, and Authentication3. Select the order of authentication. Authentication method 1 is first performed. If the authentication fails, authentication method 2 is conducted. If both authentications method 1 and authentication method 2 fail, authentication method 3 is conducted.

Description: -- means authentication is disabled and login is not possible. **local** means using username and password set in local to perform authentication. **tacacs** means using the username and password set in TACACS+ server for authentication. **radius** means using the username and password set in RADIUS server for authentication.

---



**Caution:**

If tacacs/radius is selected for Authentication1 and Authentication 2, it is recommended to configure Authentication 3 as local. This will enable the management client to login switch vis the local user if none of the configured remote authentication servers are alive.

---

## 4 System

### 4.1 Basic Information

System information includes Device Type, Device Name, MAC Address, Hardware Version, Logic Version, Software Version, Code Date, CPU Used, Memory Used, System Date, system Uptime, Contact and Location, as shown below.

Path: Home >> System >> Basic Information

Basic Information

Device Information	
Device Type	SICOM3000S-4GX8GP
Device Name	<a href="#">SWITCH</a>
MAC Address	02-00-C1-91-EB-5F
Hardware Version	V3.0
Logic Version	V1.0.0
Software Version	<a href="#">T1009</a>
Code Date	2022/08/31 09:54:59
CPU Used	52%
Memory Used	24%
System Date	<a href="#">1970-01-01T02:32:57</a>
System Uptime	0 Day(s) 2 Hour(s) 32 Minute(s) 57 Second(s)
Contact	+86-10-88798888
Location	No.901 Floor 8 to 12, Building No.2,Shixing Avenue 30#, Shijingshan District, Beijing, P. R. China 100144

Apply Refresh

Figure 14 Basic Information

### 4.2 Config Management

1. Save the current configuration information, as shown in the following figure.

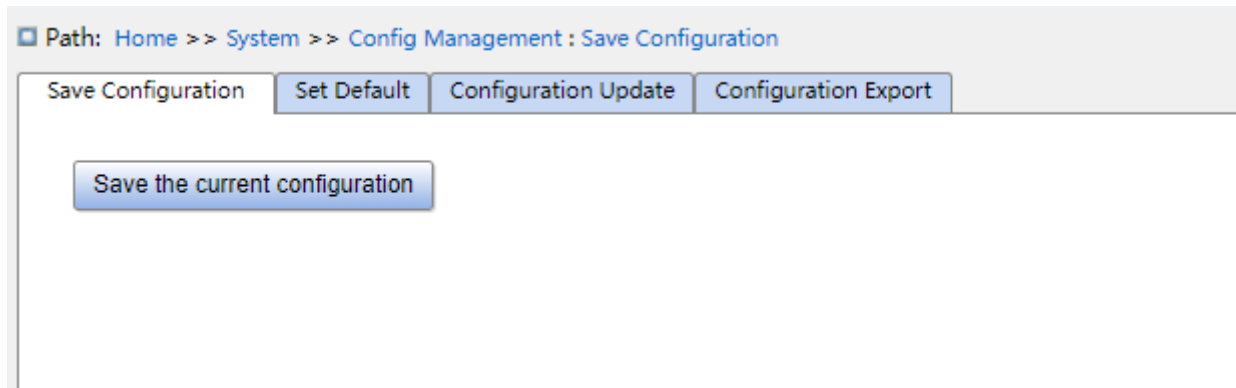

Figure 15 Save the current configuration

2. Restore the factory configuration, as shown below.

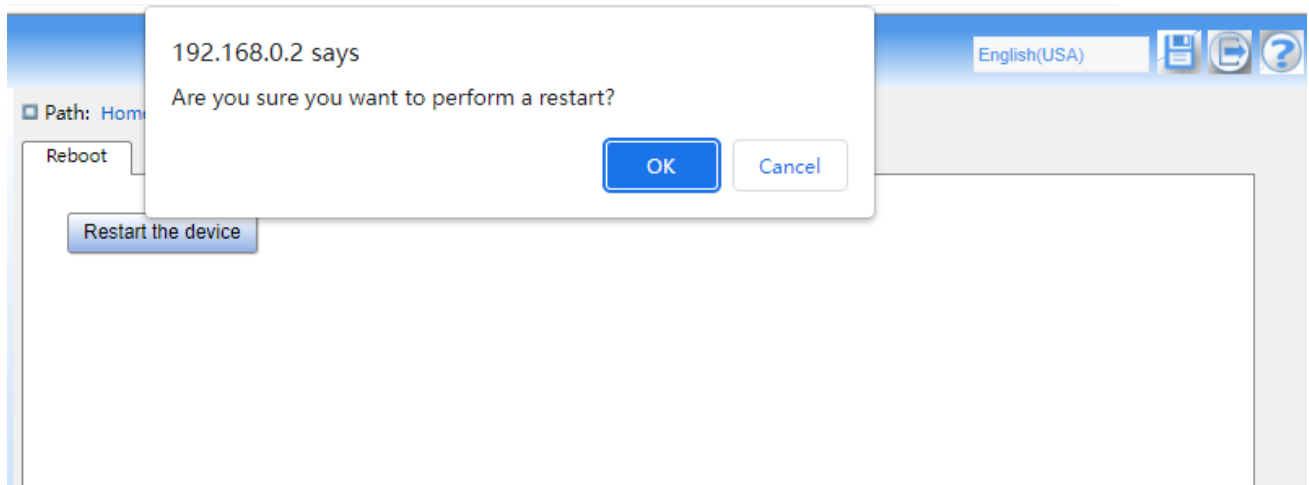

Figure 16 Restore the factory configuration

3. Configuration Export. Download the file from the switch to the local / server, as shown in Figure 17 - Figure 19.

Path: Home >> System >> Config Management : Configuration Export

Save Configuration | Set Default | Configuration Update | Configuration Export

Type:  Startup-config  Running-config

Export Way:  Export To Local  Export To FTP Server  Export To TFTP Server

Export

Figure 17 Export Configuration File-HTTP

Path: Home >> System >> Config Management : Configuration Export

Save Configuration | Set Default | Configuration Update | Configuration Export

Type:  Startup-config  Running-config

Export Way:  Export To Local  Export To FTP Server  Export To TFTP Server

Server IP Address:

Server File Name:

User Name:

Password:

Export

Figure 18 Export Configuration File –FTP

**Server IP address**

Format: A.B.C.D

Description: Configure the IP address of the FTP server.

**Server file name**

Configuration range: 1~63 characters

Description: Configure the configuration file name stored on FTP server.

**{ User name, Password }**

Configuration range: { 1~63 characters, 1~63 characters }

Description: Input the user name and password created on FTP server.



**Caution:**

- Transmission file by FTP, you need to configure FTP user name, password, and FTP server IP address.
- In the file transmission process, keeps the FTP server running.

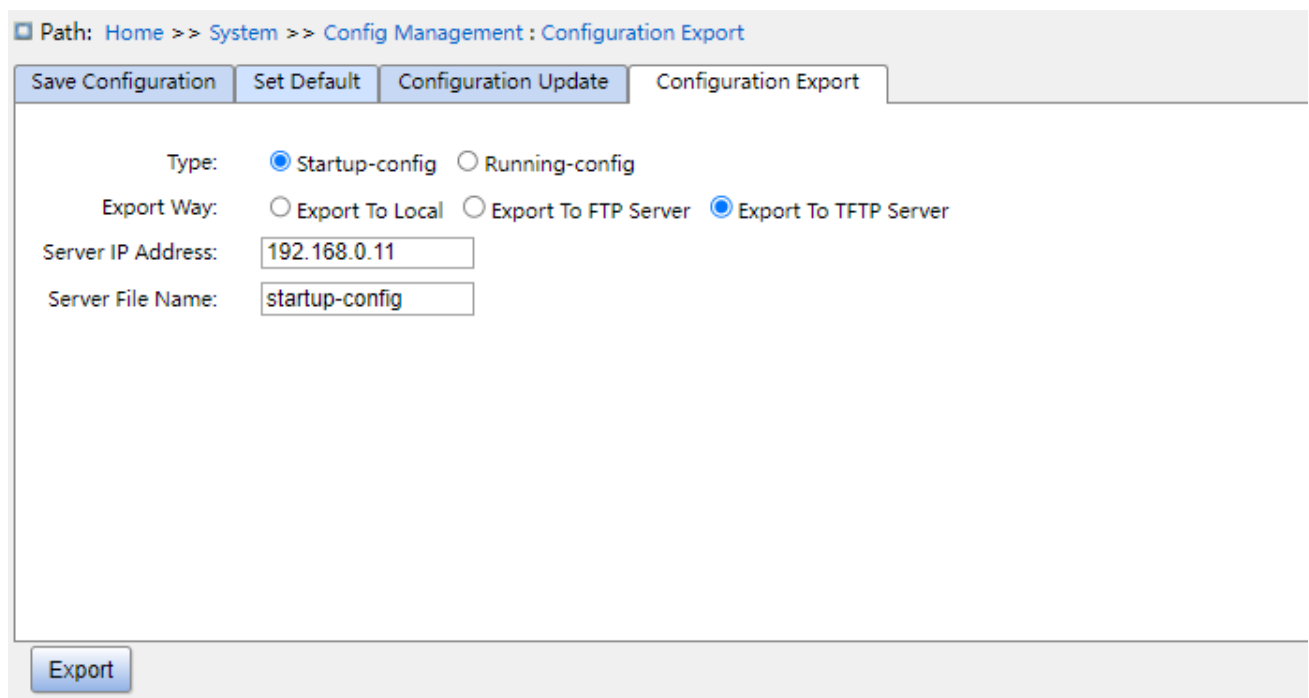

Figure 19 Export Configuration File-TFTP

You can save a file in the switch to the local /server. **running-config** is the current running configuration file of the switch, and **startup-config** is the switch startup file. Select a file and click < Export> to save the file to the local/server.

4. Configuration Update. Download the configuration file from local /server to switch as a new startup file for the switch, as shown in Figure 20 -Figure 22.

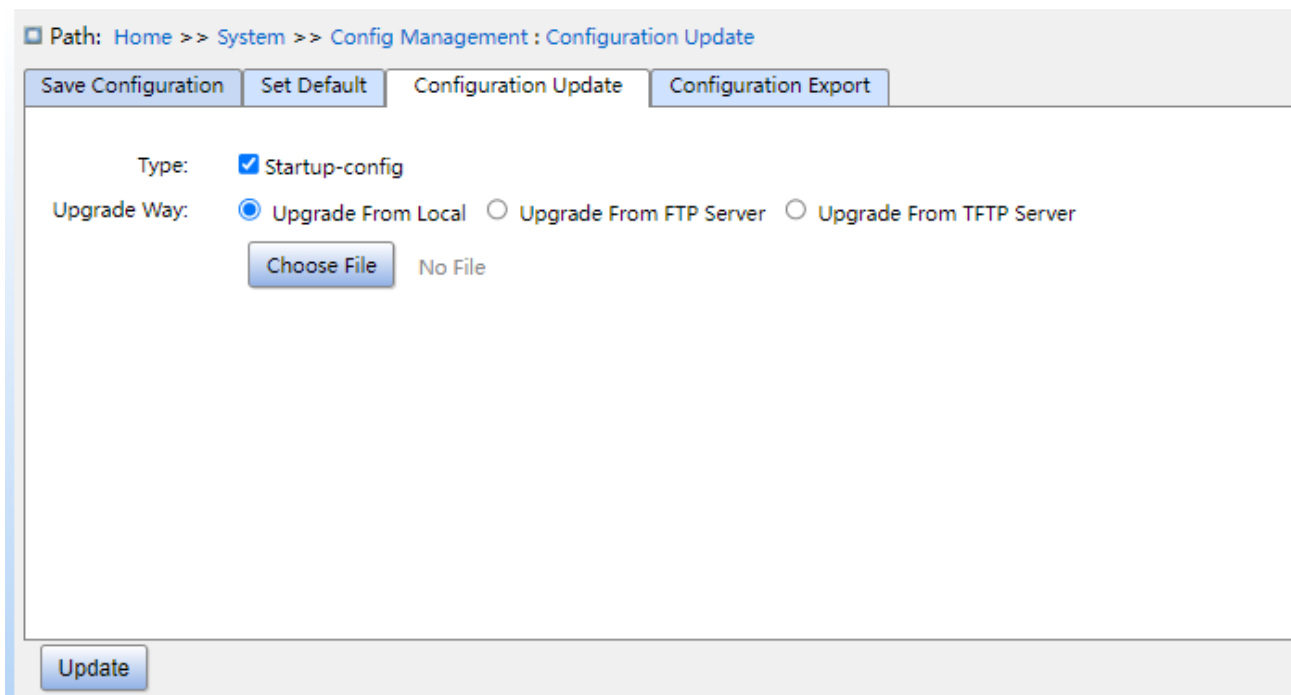

Figure 20 Download Configuration File-HTTP

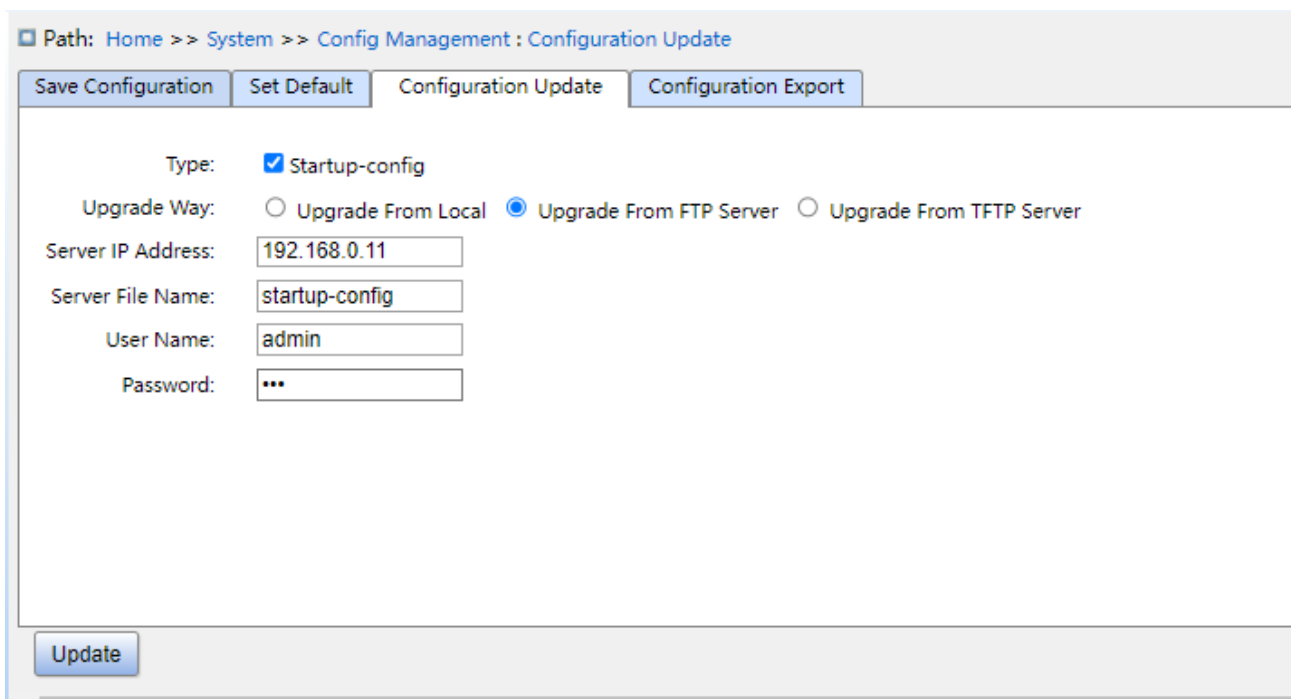

Figure 21 Download Configuration File-FTP

**Server IP address**

Configuration Format: A.B.C.D

Description: Configure the IP address of the FTP server.

**Server file name**

Configuration range: 1~63 characters

Description: Configure the firmware update file name stored on FTP server.

**{ User name, Password }**

Configuration range: { 1~63 characters, 1~63 characters }

Description: Input the user name and password created on FTP server.



**Caution:**

- When using FTP to transfer files, you need to configure the FTP user name, password, and FTP server IP address and file name.
- In the file transmission process, keep FTP server software running.

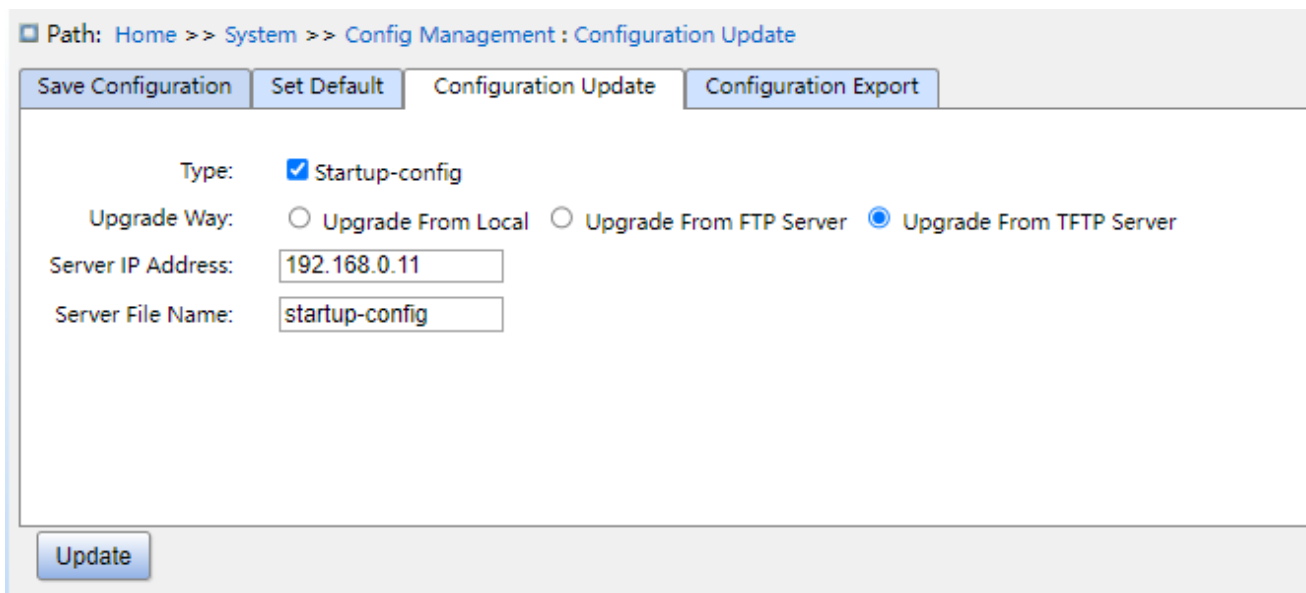

Figure 22 Download Configuration File-TFTP

You can download the configuration file from local /server to switch as a new startup file for the switch. The new startup file will replace the original **startup-config** file. Click <Update> to download the configuration file from local /server to switch.

### 4.3 Clock management

1. Set DST, as shown below.

In order to make full use of daylight and save energy in summer, you can use DST (DST: Daylight Saving Time) . DST configuration is divided into recurring and non-recurring configuration.

Path: Home >> System >> Clock Management >> Time Configuration : Set Time

Set Time

Time Zone		GMT 00:00							
Summer Time	Status	<input type="radio"/> Disable <input checked="" type="radio"/> Recurring <input type="radio"/> Non-Recurring							
	Start Time	1	Week	Mon	Jan	0	Hour	0	Min
	End Time	1	Week	Mon	Jan	0	Hour	0	Min
	Offset	1 (1~1439Min)							

Figure 23 recurring configuration

Path: Home >> System >> Clock Management >> Time Configuration : Set Time

Set Time

Time Zone		GMT 00:00								
Summer Time	Status	<input type="radio"/> Disable <input type="radio"/> Recurring <input checked="" type="radio"/> Non-Recurring								
	Start Time	Jan	1	Day	2014	Year	0	Hour	0	Min
	End Time	Jan	1	Day	2097	Year	0	Hour	0	Min
	Offset	1 (1~1439Min)								

Figure 24 Non-recurring configuration

**Time zone**

Function: select local time zone.

**DST status**

Configuration options: disable/recurring/non-recurring

Default configuration: disable

Function: Whether enable daylight saving time, after enable, select DST mode, recurring mode by year.

**Start time/end time**

Function: after enabling DST, set the time range of DST. Non-recurring mode configure year, month, day, hour and minute to appoint the operation range of DST, as shown Figure 23 set DST between 00:00 on 1 January in 2014 and 23:59 on 1 July in 2097. Recurring mode configure month, week, date, hour and minute to appoint the operation range of DST per



year, as Figure 22 set DST between 00:00 on the first Monday in January and 23:59 on the first Monday in July per year.

### Offset

Configuration range: 1~1439min

Default configuration: 1min

Function: configure DST offset, that is start time of DST, and advanced time.



#### Caution:

- The start time and end time should be different:
  - The start time is non-DST time, the end time is DST time.
- 

Example: the DST time from 10:00:00 on April 1 to 9:00:00 on October 1, so the DST offset is 60 min.

Non-DST time runs to 10: 00: 00 on April 1 and jumps directly to 11: 00: 00 DST to begin DST. When DST runs to 9: 00: 00 on October 1, it returns to 8: 00: 00 non-DST.

## 2、NTP configuration

NTP (network time protocol) is used to synchronize time between the distributed time server and the client. NTP can synchronize the clock of all devices with clock in the network, so that the clock of all devices in the network is same. So that the device can provide a variety of applications based on the same time. For the local system running NTP, it can receive synchronization from other clock sources or synchronize other clocks as clock sources.

Path: Home >> System >> Clock Management >> Time Configuration : NTP

Set Time   NTP   **SNTP**

NTP Status:    Enable

Server Address 1:  

Server Address 2:  

Server Address 3:  

Server Address 4:  

Server Address 5:  

Figure 25 NTP configuration

**NTP status**

Configuration options: enable/disable

Default configuration: disable

Function: Whether enable global NTP services.



**Caution:**

- NTP and SNTP protocol mutually exclusive. Because NTP and SNTP use the same UDP port , both cannot be enabled at the same time;
- When NTP services are disable, NTP services can be configured and saved, that is, the enable or disable NTP services does not affect the configuration of NTP services.

**Server address 1/ server address 2/ server address 3/ server address 4/ server address 5**

Configuration format: A.B.C.D

Function: Configure the IP address of the NTP server, and the client will calibrate time according to NTP server’s message.

**3、SNTP configuration**

SNTP(Simple Network Time Protocol)protocol calibrates time by requesting and responding between the server and the client. The switch as a client calibrate the time according to the

server's message.



**Caution:**

- When the switch enables SNTP, the SNTP server should be active.
- The time information in SNTP protocol is standard time information of the 0 time zone.

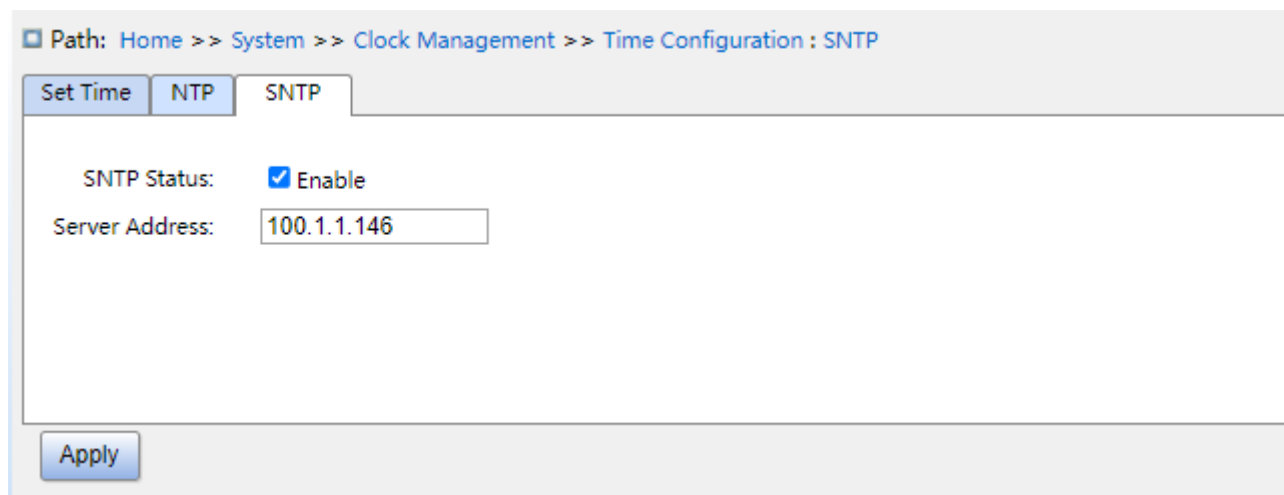

Figure 26 SNTP configuration

**SNTP status**

Configuration options: enable/disable

Default configuration: disable

Function: Whether enable SNTP.

**Server address**

Configuration format: A.B.C.D

Function: Configure the IP address of the SNTP server, and the client will calibrate time according to the services message.

4. Check if the switch time is synchronized with server time.

Click on the navigation tree [system] → [basic information] to view system time information, as shown below.

Path: Home >> System >> Basic Information

Basic Information

Device Information	
Device Type	SICOM3000S-4GX8GP
Device Name	<a href="#">SWITCH</a>
MAC Address	02-00-C1-91-EB-5F
Hardware Version	V3.0
Logic Version	V1.0.0
Software Version	<a href="#">T1009</a>
Code Date	2022/08/31 09:54:59
CPU Used	52%
Memory Used	24%
System Date	<a href="#">1970-01-01T02:59:03</a>
System Uptime	0 Day(s) 2 Hour(s) 59 Minute(s) 3 Second(s)
Contact	+86-10-88798888
Location	No.901 Floor 8 to 12, Building No.2,Shixing Avenue 30#, Shijingshan District, Beijing, P. R. China 100144

Apply Refresh

Figure 27 view clock information

View switch time information according to server time, time zone and DST configuration.

## 4.4 Software update

Switches can achieve better performance by upgrading software versions. This series of switch upgrades include boot version upgrade and software version upgrade, first upgrade the boot version then upgrade the software version, only the software version is upgraded when the boot version remains the same. The software version can be upgraded through the Local/FTP/TFTP protocol.

### 4.4.1 Local update

1. Local upgrade software, as shown below.

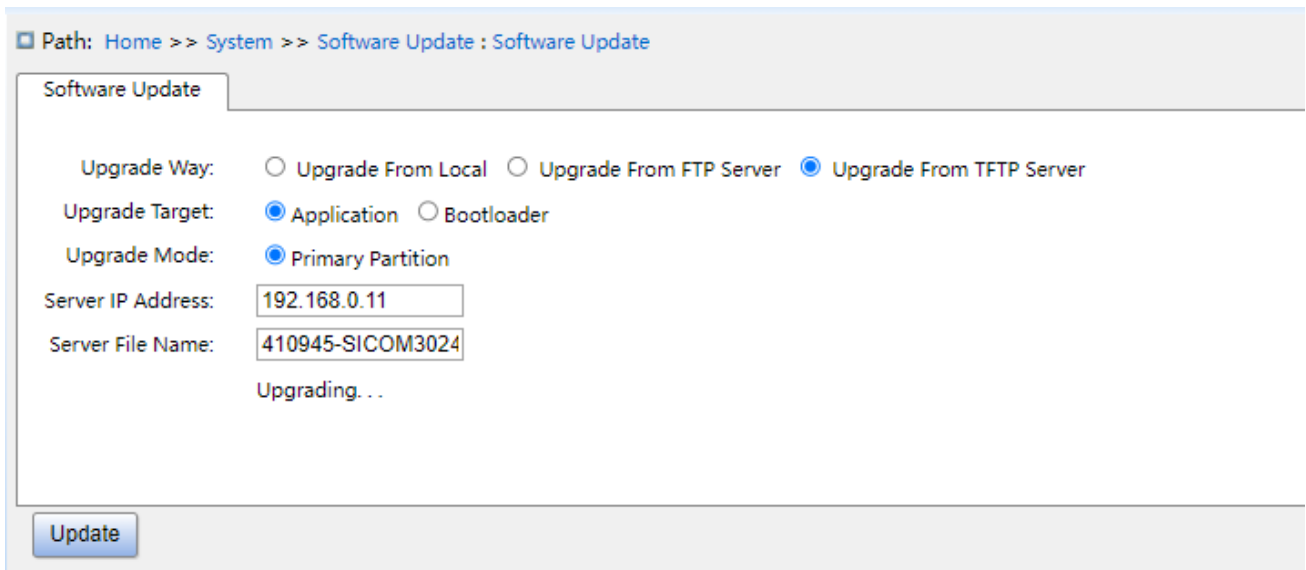

Figure 28 upgrade software-Local

**Upgrade way**

Configuration options: upgrade from local/upgrade from FTP server/ Upgrade From TFTP Server.

Function: select upgrade way.

**Upgrade target**

Configuration options: software version/Boot version

Function: select upgrade target.

**Upgrade mode**

Configuration options: primary partition/backup partition

Description: two versions of software can be downloaded, the two versions can be the same or different.

2. After upgrading successfully, as shown in figure 28, activate the software version and restart the device, then check if the software version is the upgraded version in the system information.

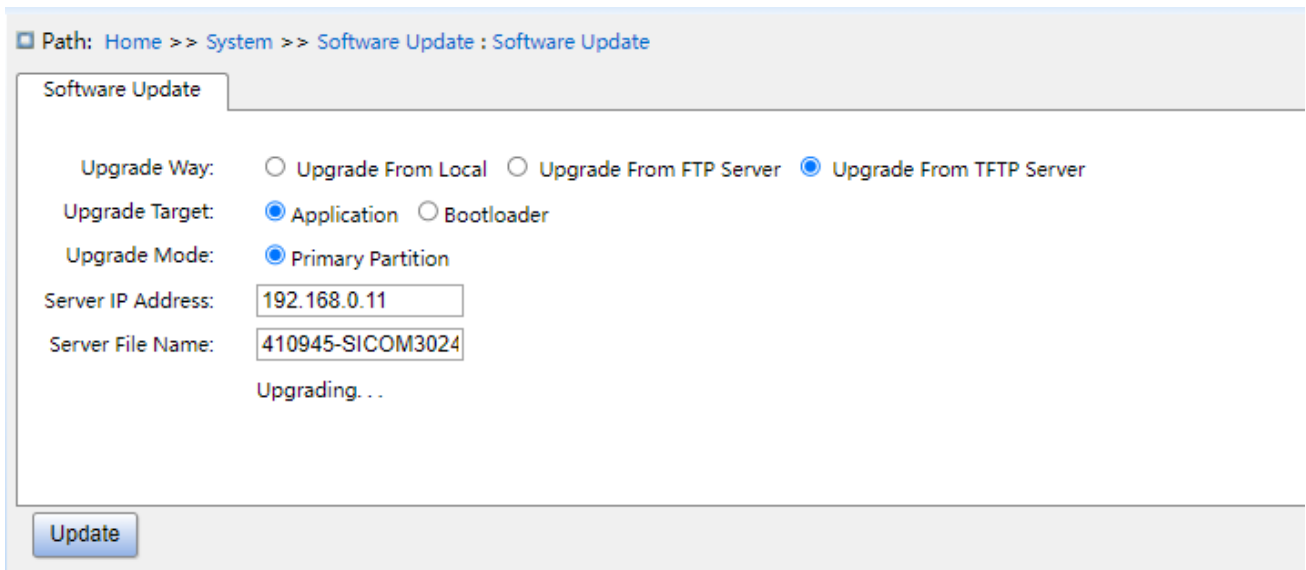

Figure 29 upgrade successfully



**Warning:**

- After the software upgrade is successful, you must activate the software version and restart the device before the software version can take effect;
- Cannot restart switch after upgrade failure, avoid version file loss and device can not start normally.

**4.4.2 FTP upgrade**

Install an FTP server. The following uses WFTPD software as an example to introduce FTP server configuration and software update.

1. Click [Security] → [Users/Rights]. The "Users/Rights Security Dialog" dialog box is displayed. Click <New User> to create a new FTP user, as shown in Figure 30. Create a user name and password, for example, user name "admin" and password "123". Click <OK>.

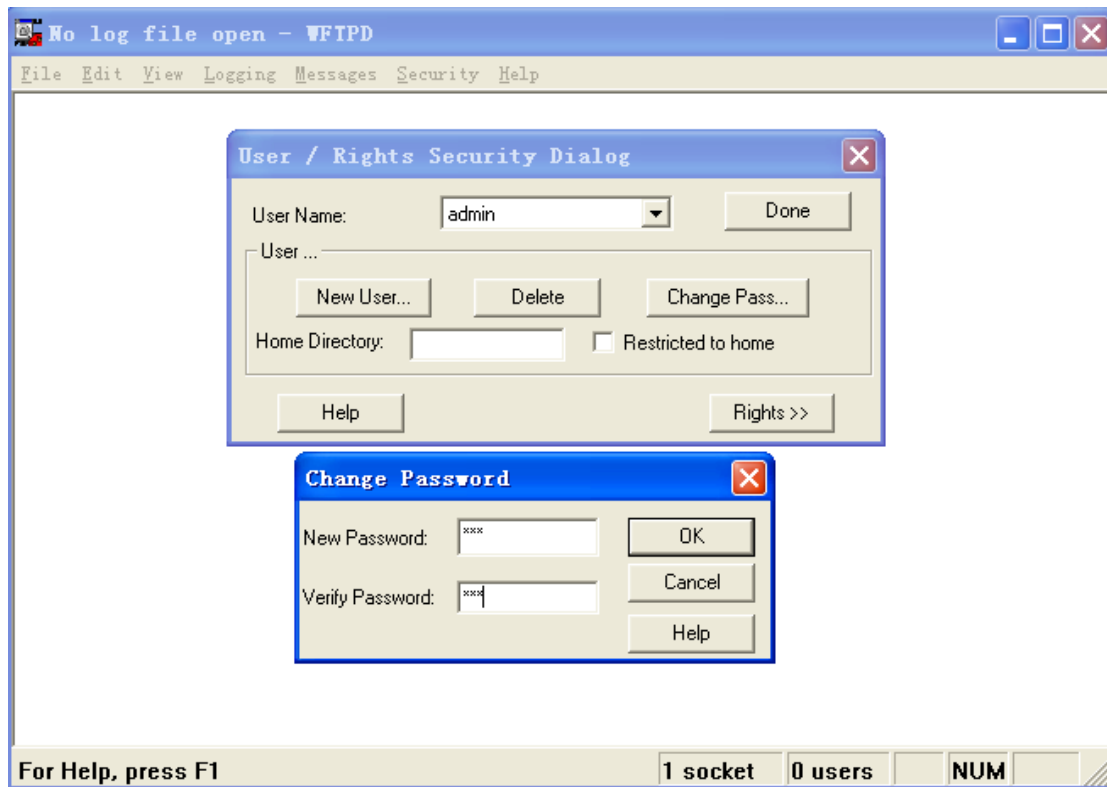

Figure 30 Creating a New FTP User

2. Input the storage path of the update file in "Home Directory", as shown in Figure 31. Click <Done>.

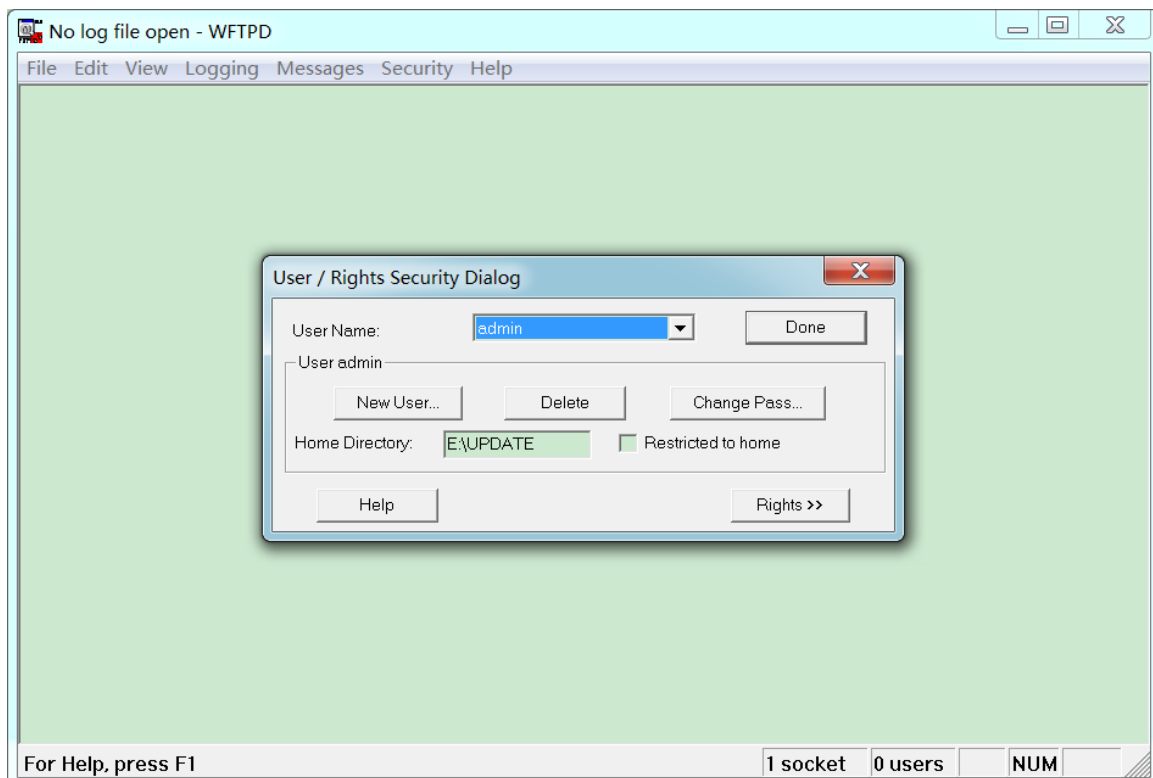

Figure 31 File Location

3. Click [System] → [Software Update] in the navigation tree to enter the software update page, as shown in Figure 32. Enter the IP address of FTP server, FTP user name, password, and file name on the server. Click <Update>.

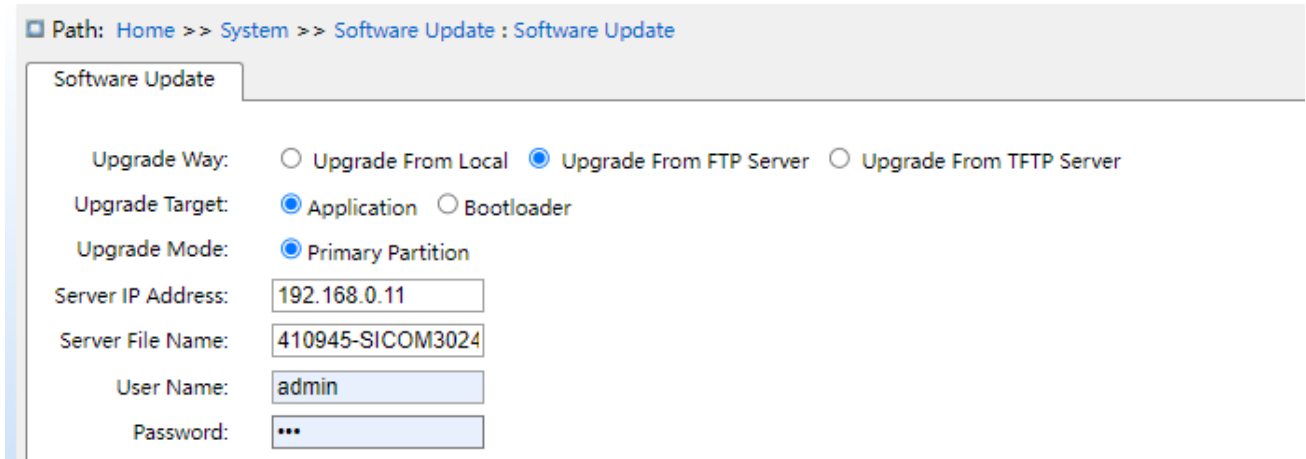

Figure 32 Software Update by FTP

**Upgrade Way**

Configuration options: Upgrade From Local / Upgrade From FTP Server/ Upgrade From TFTP Server

Explanation: Select upgrade mode

**Upgrade Target**

Configuration options: Application/Bootloader

Function: Select the upgrade target.

**Upgrade Mode**

Configuration options: Primary Partition/Backup Partition

Description: Two firmware versions can be downloaded to the switch, and they can be the same or different.



**Warning:**

The file name must contain an extension. Otherwise, the update may fail.

4. Make sure the normal communication between the FTP server and the switch, as shown below.



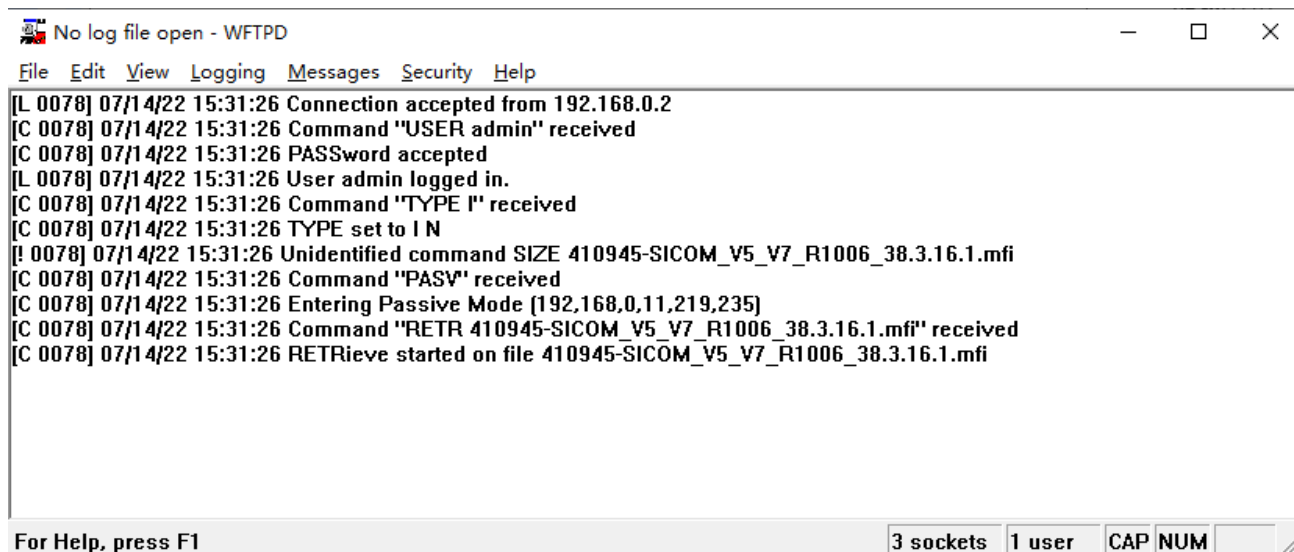

Figure 33 Normal Communication between FTP Server and Switch



**Caution:**

To display update log information as shown in Figure 33, you need to click [Logging] → [Log Options] in WFTPD and select Enable Logging and the log information to be displayed.

5. Wait for the update to complete, as shown in Figure 34;

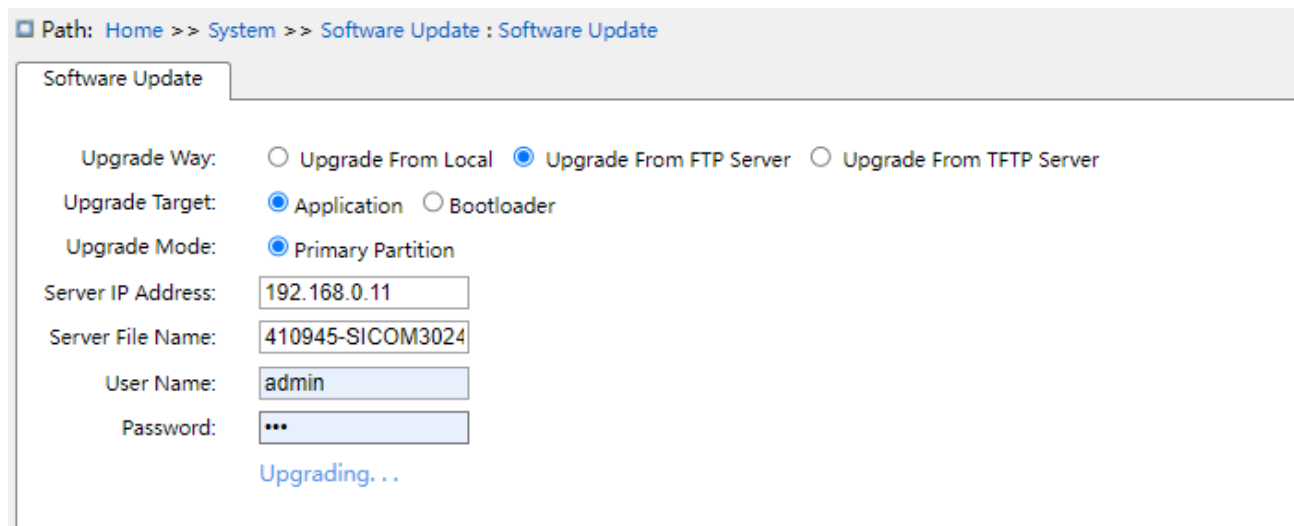

Figure 34 Waiting for the Update to Complete

6. When the update is completed, please reboot the device and open the Switch Basic Information page to check whether the update succeeded and the new version is active.



**Warning:**

➤ In the software update process, keeps the FTP server software running.

- When update completes, reboot the device to activate the new version.
- If update fails, do not reboot the device to avoid the loss of software file and startup anomaly.

### 4.4.3 TFTP upgrade

Install TFTP server. The following uses TFTP software as an example to introduce TFTP server configuration.

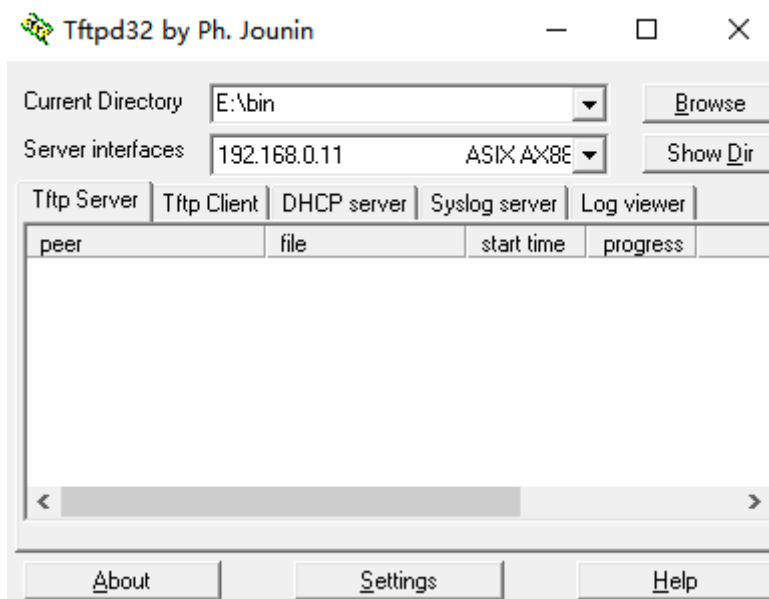

Figure 35 TFTP Server Configuration

1. In "Current Directory", select the storage path of update file on server. Enter the server IP address in "Server interface".
2. Click [System] → [Software Update] in the navigation tree to enter the software update page, as shown below. Enter the IP address of the TFTP server and file name on server. Click <Update>, and wait for update to complete.

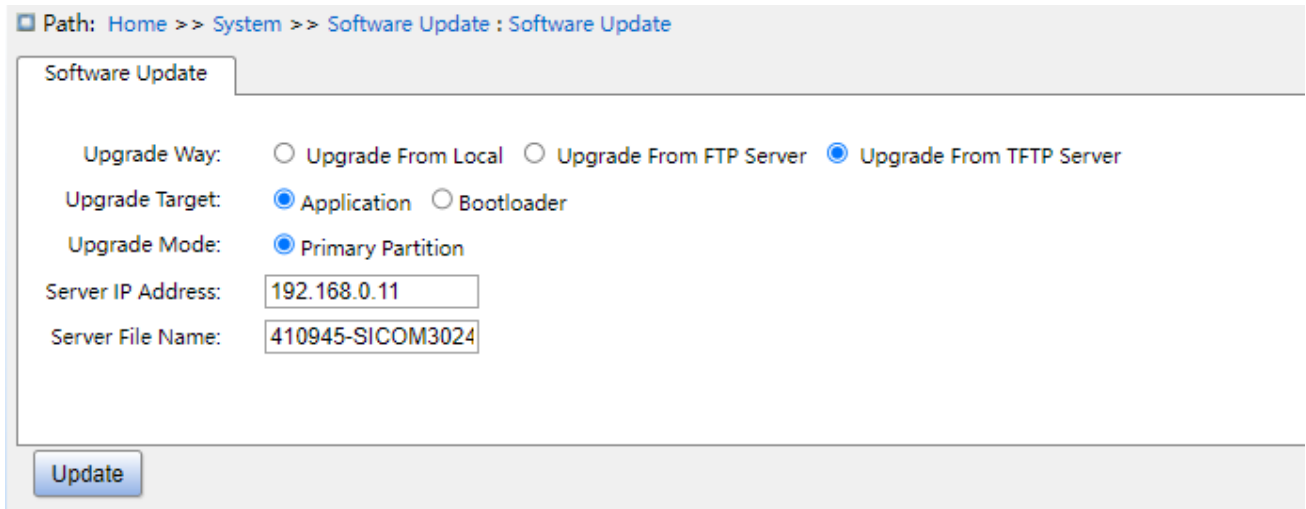

Figure 36 Software Update by TFTP

3. Make sure the normal communication between the TFTP server and the switch, as shown below.

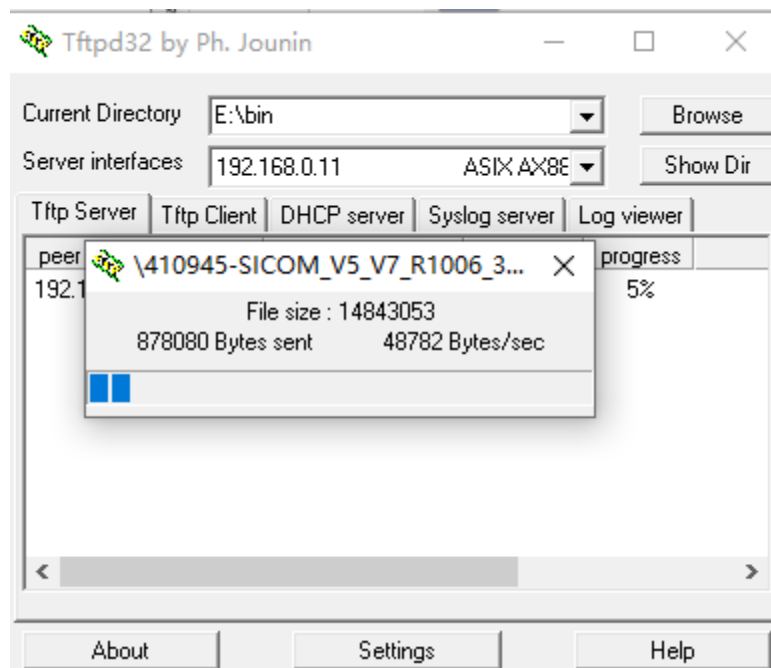

Figure 37 Normal Communication between TFTP Server and Switch

4. Wait for the update to complete, as shown below.

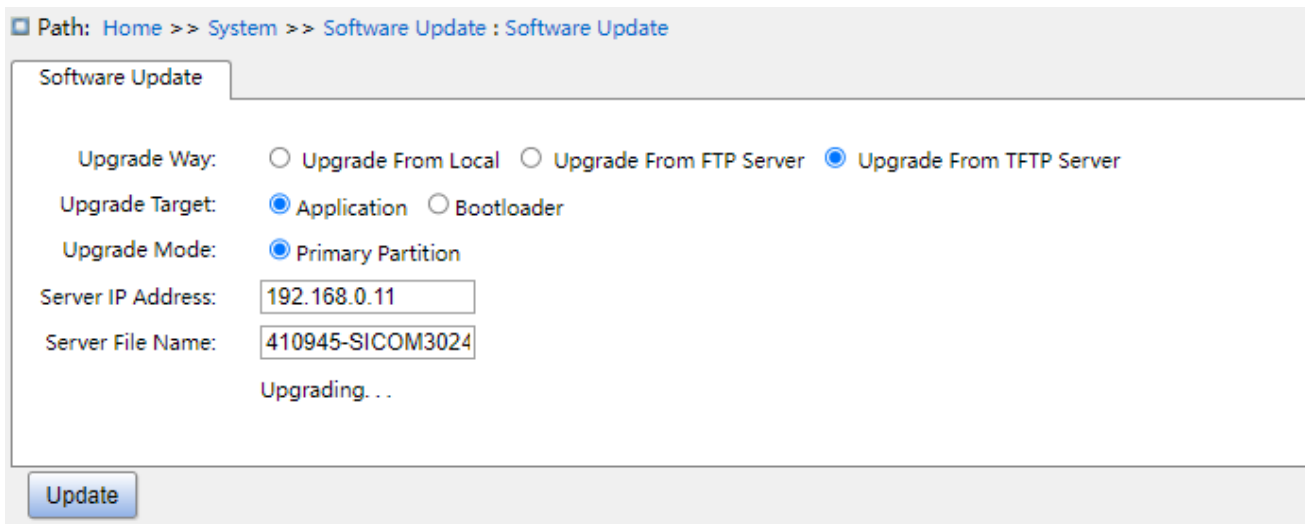

Figure 38 Waiting for Update to Complete

5. When the update is completed, please reboot the device and open the Switch Basic Information page to check whether the update succeeded and the new version is active.



**Warning:**

- In the software update process, keeps the TFTP server software running.
- When update completes, reboot the device to activate the new version.
- If update fails, do not reboot the device to avoid the loss of software file and startup anomaly.

### 4.5 Restart

Restart device, as shown below.

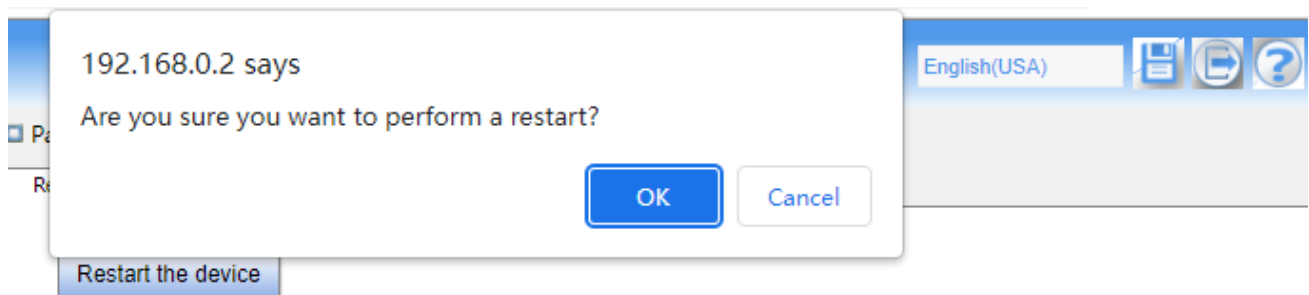

Figure 39 restart device

Before restarting the device, confirm whether save the current configuration, the switch configuration is the latest information after reboot, and if not, the switch configuration will be

restored to the factory Default configuration after reboot.

## 4.6 Abort

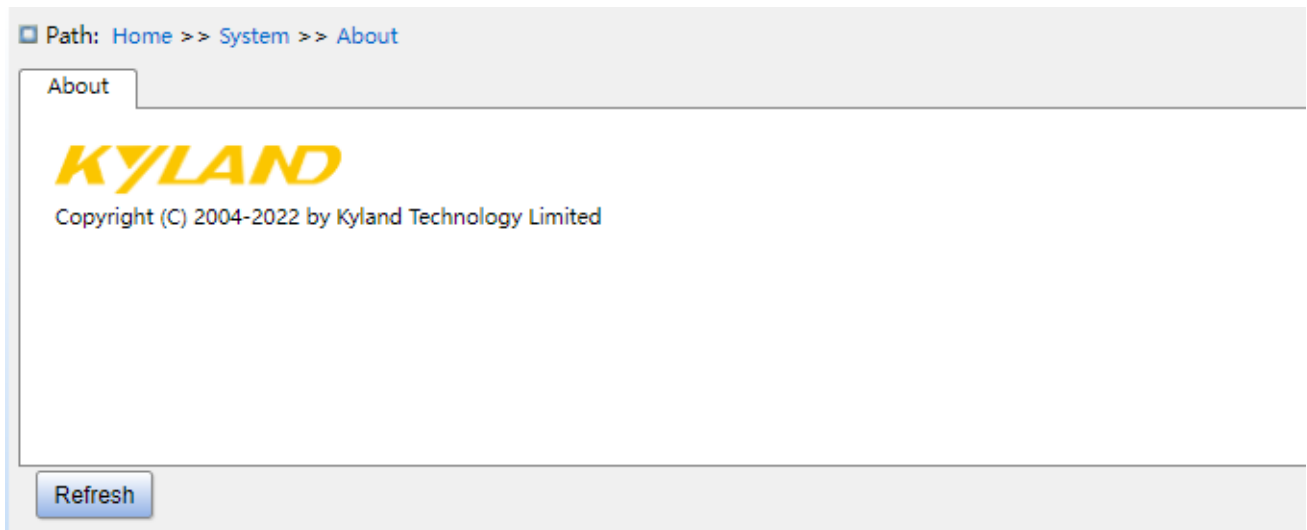

Figure 40 System related information

## 5 Service

### 5.1 SSL Configuration

#### 5.1.1 Introduce

SSL (Secure Socket Layer) is a security protocol and provides the security link for the TCP-based application layer protocol, such as HTTPS. SSL encrypts the network connection at the transport layer and uses the symmetric encryption algorithm to guarantee the data security, and uses the secret key authentication code to ensure the information reliability. This protocol is widely used in Web browser, receiving and sending emails, network fax, real time communication, and so on, providing an encryption protocol for the security transmission in the network.

#### 5.1.2 Web Configuration

1. Enable HTTPS, as shown below.

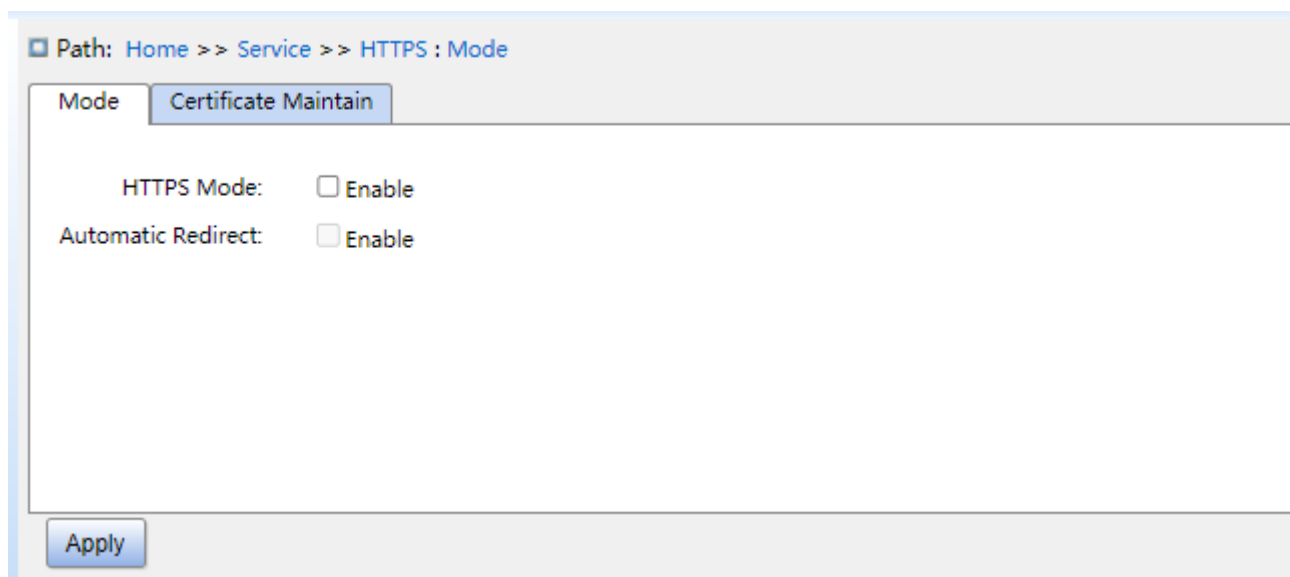

Figure 41 Enable HTTPS

#### HTTPS Mode

Configuration options: Enable /Disable

Default configuration: Disable

Function: enable or disable HTTPS, if enable, login in the switch Web interface via `http://ip`

address and secure link https://ip address.

**Automatic redirection**

Configuration options: Enable /Disable

Default configuration: Disable

Function: if enable, only secure link https://ip address is allowed to login switch web pages. If disable, the switch web page can be login via http and https. The automatic redirect parameter only can be configured when the https status is enable.

2. Certificate management, as shown below.

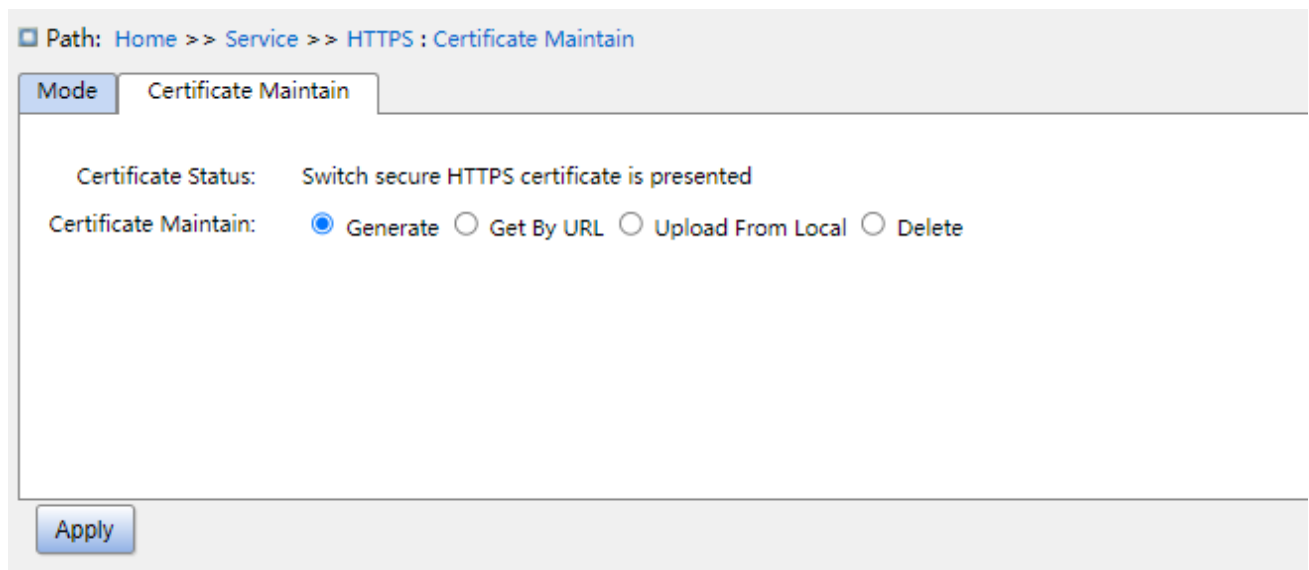

Figure 42 Generate certificate

**Maintain**

Configuration options: Generate/Get by URL/Upload from local/Delete

Function: select upload mode of certificate

Get certificate by URL

**URL**

Function: set web path such as [https://10.10.10.10:80/new\\_image\\_path/new\\_image.dat](https://10.10.10.10:80/new_image_path/new_image.dat)

Upload from local

**Select file**

Function: select HTTPS certificates file from local.

## 5.2 SNMP v1/SNMP v2c

### 5.2.1 Introduction

The Simple Network Management Protocol (SNMP) is a framework using TCP/IP to manage network devices. With the SNMP function, the administrator can query device information, modify parameter settings, monitor device status, and discover network faults.

### 5.2.2 Implementation

SNMP adopts the management station/agent mode. Therefore, SNMP involves two types of NEs: NMS and agent.

The Network Management Station (NMS) is a station running SNMP-enabled network management software client. It is the core for the network management of an SNMP network.

Agent is a process in the managed network devices. It receives and processes request packets from the NMS. When an alarm occurs, the agent proactively reports it to the NMS. The NMS is the manager of an SNMP network, while agent is the managed device of the SNMP network. The NMS and agents exchange management packets through SNMP.

SNMP involves the following basic operations:

Get-Request

Get-Response

Get-Next-Request

Set-Request

Trap

The NMS sends Get-Request, Get-Next-Request, and Set-Request packets to agents to query, configure, and manage variables. After receiving these requests, agents reply with Get-Response packets. When an alarm occurs, an agent proactively reports it to the NMS with a trap packet.

### 5.2.3 Explanation

This series switches support SNMP v2c. SNMP v2c is compatible with SNMPv1.



SNMP v1 uses community name for authentication. A community name acts as a password, limiting NMS's access to agents. If the community name carried by an SNMP packet is not acknowledged by the switch, the request fails and an error message is returned.

SNMP v2c also uses community name for authentication. It is compatible with SNMP v1, and extends the functions of SNMP v1.

To enable the communication between the NMS and agent, their SNMP versions must match. Different SNMP version can be configured on an agent, so that it can use different versions to communicate with different NMSs.

### 5.2.4 MIB Introduction

Any managed resource is called managed object. The Management Information Base (MIB) stores managed objects. It defines the hierarchical relationships of managed objects and attributes of objects, such as names, access permissions, and data types. Each agent has its own MIB. The NMS can read/write MIBs based on permissions. Figure 43 shows the relationships among the NMS, agent, and MIB.

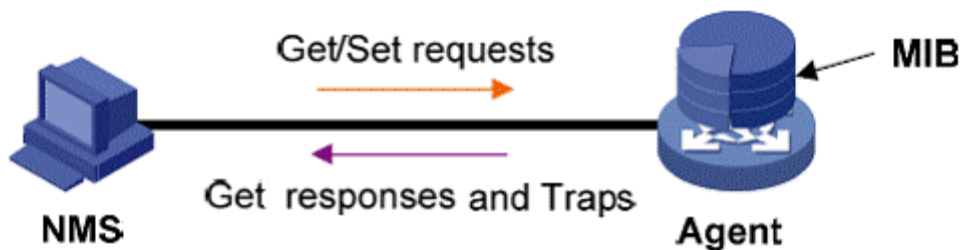

Figure 43 Relationship among NMS, Agent, and MIB

MIB defines a tree structure. The tree nodes are managed objects. Each node has a unique Object Identifier (OID), which indicates the location of the node in the MIB structure. As shown in Figure 44, the OID of object A is 1.2.1.1.

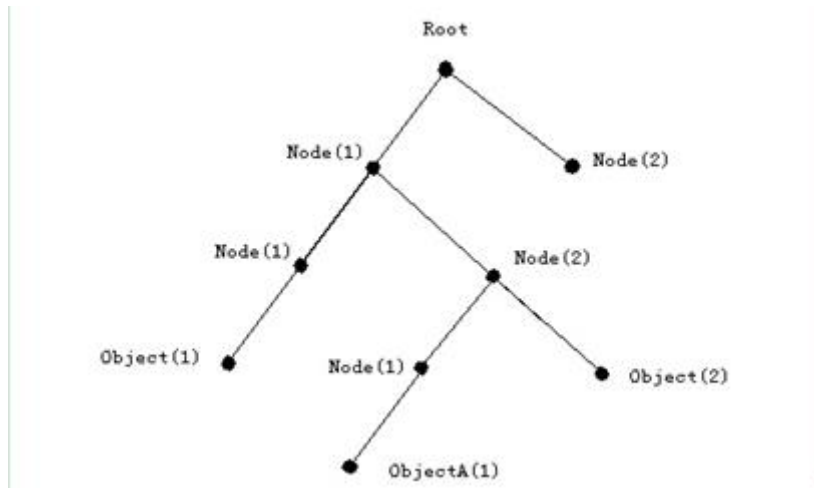

Figure 44 MIB Structure

### 5.2.5 Web Configuration

1. Enable SNMP, as shown below.

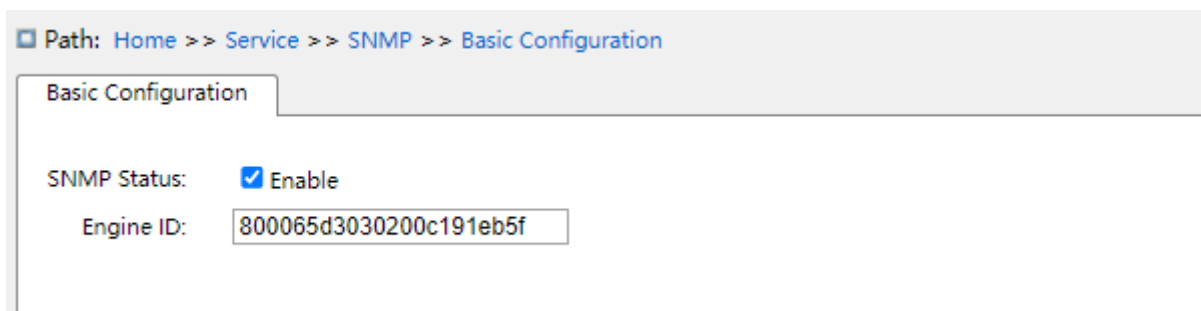

Figure 45 Enable SNMP

#### SNMP status

Configuration options: Enable/Disable

Default configuration: Enable

Function: Enable or disable SNMP.

#### Engine ID

Configuration range: hexadecimal number is even, can not be all 0 or F, the value range of even number is 10~64.

Function: Configure SNMP v3 system engine ID, the user corresponding to the device ID in the user table will be clear when the engine ID is modified.

2. Configure Community, as shown below.

Path: Home >> Service >> SNMP >> Community Configuration

Community Configuration

Index	Community	Version	Access Priority
1	public	V2C	<input checked="" type="radio"/> Read Only <input type="radio"/> Read And Write
2	private	V2C	<input type="radio"/> Read Only <input checked="" type="radio"/> Read And Write
3		V1	<input checked="" type="radio"/> Read Only <input type="radio"/> Read And Write
4		V1	<input checked="" type="radio"/> Read Only <input type="radio"/> Read And Write
5		V1	<input checked="" type="radio"/> Read Only <input type="radio"/> Read And Write
6		V1	<input checked="" type="radio"/> Read Only <input type="radio"/> Read And Write
7		V1	<input checked="" type="radio"/> Read Only <input type="radio"/> Read And Write
8		V1	<input checked="" type="radio"/> Read Only <input type="radio"/> Read And Write
9		V1	<input checked="" type="radio"/> Read Only <input type="radio"/> Read And Write
10		V1	<input checked="" type="radio"/> Read Only <input type="radio"/> Read And Write
11		V1	<input checked="" type="radio"/> Read Only <input type="radio"/> Read And Write
12		V1	<input checked="" type="radio"/> Read Only <input type="radio"/> Read And Write
13		V1	<input checked="" type="radio"/> Read Only <input type="radio"/> Read And Write
14		V1	<input checked="" type="radio"/> Read Only <input type="radio"/> Read And Write
15		V1	<input checked="" type="radio"/> Read Only <input type="radio"/> Read And Write
16		V1	<input checked="" type="radio"/> Read Only <input type="radio"/> Read And Write

Apply

Figure 46 Configure Community

**Community**

Configuration range: 1~32 characters

Function: configure the community of switch.

Description: The MIB library information of the switch can only be accessed when the community name in the snmp message is consistent with the community string.

Note: up 16 community strings can be configured.

**Access Priority**

Configuration options: Read Only/Read and Write

Default configuration: Read Only.

Function: configure the access priority of MIB library.

Description: the MIB library information only can be ready with read-only permissions; the MIB library information can be read with read and write permissions.

3. Configure trap, as shown below.

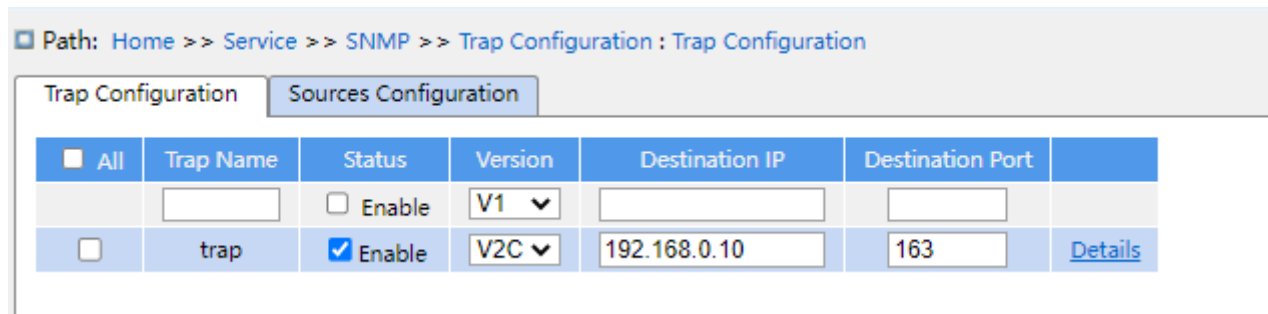

Figure 47 Configure trap

**Trap name**

Configuration range: 1~32 characters

Function: configure trap name.

**status**

Configuration options: enable/disable

Default configuration: disable

Function: enable or disable trap, the switch sends the corresponding trap message to the server if enable.

**Version**

Configuration options: SNMP v1/SNMP v2c/SNMP v3

Default configuration: SNMP v1

Function: configurate the trap message version number that the switch sends to the server.

**Destination IP**

Configuration format: A.B.C.D

Function: Configure the server address where the trap message is received.

**Destination Port**

Configuration range: 1~65535

Default configuration: 162

Function: Configure the port number that sends the trap message.

4. Click on the trap configuration item details to see the trap configuration details, as shown below.

Path: Home >> Service >> SNMP >> Trap Configuration : Trap Configuration -> Detail[trap]

Detail[trap] Sources Configuration

[<<Back](#)

Trap Name:

Status:  Enable

Version:

Community:

Destination IP:

Destination Port:

Inform Mode:  Enable

Inform Timeout(sec):

Inform Retry Times:

Engine ID:

Security Name:

Figure 48 trap detail information

**Community**

Configuration range: 0~255 characters

Default configuration: public

Function: Configure the community name that is carried in the sending trap message.

**Inform Mode**

Configuration options: enable/disable

Default configuration: disable

Function: Whether the server sends a reply message to the switch after receiving the trap message.

**Inform Timeout**

Configuration range: 0~2147s

Default configuration: 3s

Function: Configure the trap message sending timeout; after the switch sends the trap message, if no response from the server within that time, resend the trap message.

**Inform retry Times**

Configuration range: 0~255

Default configuration: 5

Function: Configure the number of times the trap message is timed out. If the cumulative number of sending times exceeds the configuration value, the server still does not reply, then the trap message sends failed.

5. Configure trap event, as shown below.

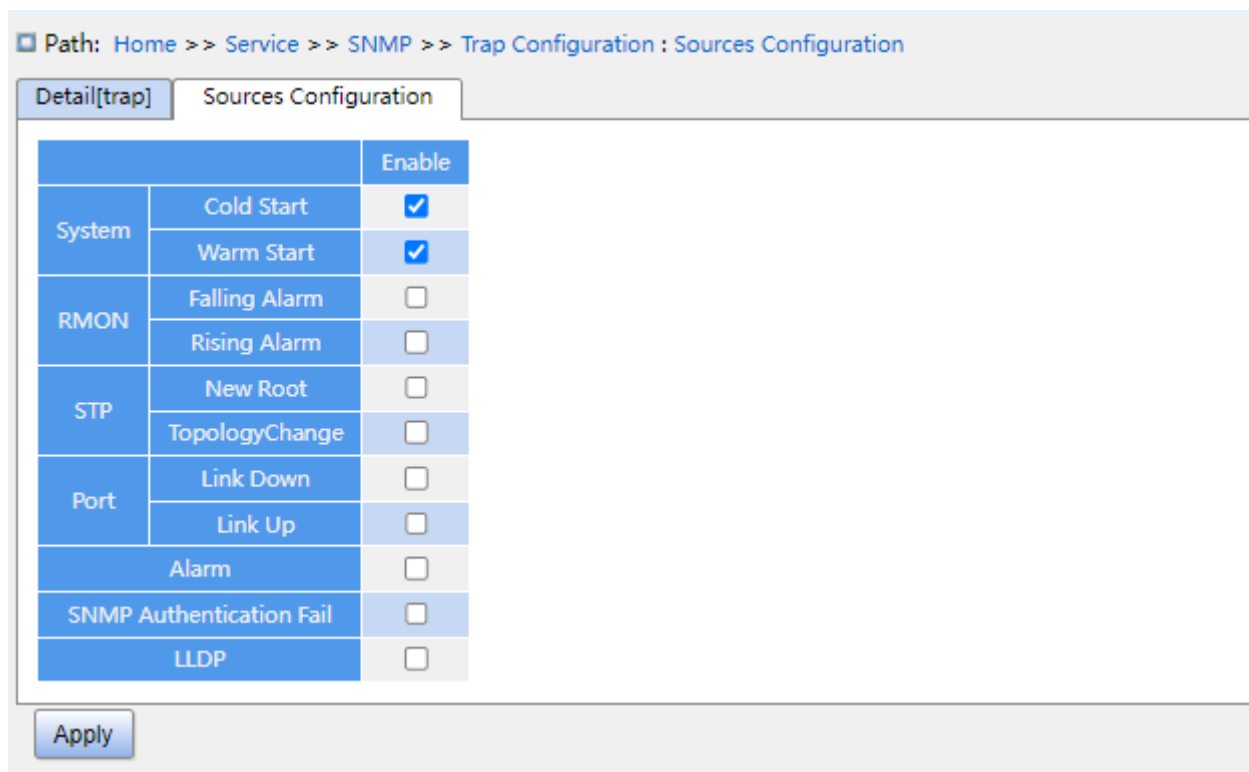

Figure 49 trap source configuration

**System warm start/cold start**

Configuration options: enable/disable

Default configuration: disable

Function: Whether to send trap message when the system is warm start / cold start.c

**RMON falling alarm/rising alarm**

Configuration options: enable/disable

Default configuration: disable

Function: Whether to send a trap message when the RMON generates a failing alarm / rising alarm.

### **STP new root/ topology change**

Configuration options: enable/disable

Default configuration: disable

Function: Whether to send the trap message when the state of STP changes.

### **Port link up/down**

Configuration options: enable/disable

Default configuration: disable

Function: Whether to send trap message of port up/down when port status changes.

### **Alarm**

Configuration options: enable/disable

Default configuration: disable

Function: When there is alarm information, whether to send trap message.

### **SNMP authentication fail**

Configuration options: enable/disable

Default configuration: disable

Function: If snmp authentication fails, whether to send trap message.

### **LLDP**

Configuration options: enable/disable

Default configuration: disable

Function: Whether to send LLDP trap message when the neighbor status changes.

## **5.2.6 Typical Configuration Example**

SNMP management server is connected to the switch through Ethernet. The IP address of the management server is 192.168.0.23, and that of the switch is 192.168.0.2. The NMS monitors and manages the Agent through SNMP v2c, and reads and writes the MIB node information of the Agent. When the Agent is faulty, it proactively sends trap packets to the NMS, as shown in Figure 50.

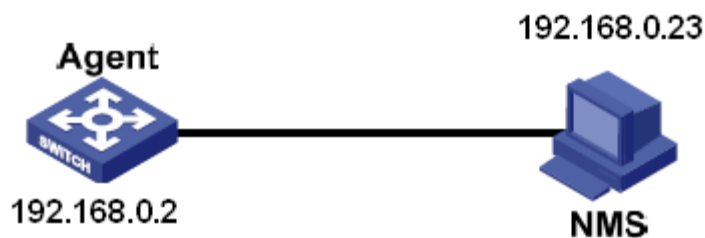

Figure 50 SNMP v2c Configuration Example

### Configuration on Agent:

1. Enable SNMP and v2c state; configure access rights with Read only community "public" and Read and write community "private", as shown in Figure 45、 Figure 46.
2. Configure global trap mode, as shown in Figure 47.
3. Create trap entry 111, enable trap mode; set the trap version to SNMP v2c, destination IP address to 192.168.0.23. Select system, interface, authentication, and switch all trap events, and adopt default settings for the other parameters, as shown in Figure 48、 Figure 49.

If you want to monitor and manage Agent devices, run the corresponding management software in NMS, such as Kyvision developed by Kyland.

For details about operations of Kyvision, refer to the *Kyvision Operation Manual*.

## 5.3 SNMPv3

### 5.3.1 Introduce

SNMP v3 provides a User-Based Security Model (USM) authentication mechanism. You can configure authentication and encryption functions. Authentication is used for verifying the validity of packet sender, preventing illegitimate users' access. Encryption is used for encrypt packets transmitted between the NMS and the Agent, avoiding interception. The authentication and encryption functions can improve the security of communication between the SNMP NMS and the SNMP Agent.

To enable the communication between the NMS and agent, their SNMP versions must match. Different SNMP version can be configured on an agent, so that it can use different versions to communicate with different NMSs.



### 5.3.2 Implementation

SNMP v3 provides four configuration tables. Each table can contain 16 entries. These tables determine whether specific users can access MIB information.

You can create multiple users in the user table. Each user uses different security policies for authentication and encryption.

The group table is the collection of multiple users. In the group table, access rights are defined based on user groups. All the users of a group have the rights of the group.

The view table refers to the MIB view information, which specifies the MIB information that can be accessed by users. The MIB view may contain all nodes of a certain MIB subtree (that is, users are allowed to access all nodes of the MIB subtree) or contain none of the nodes of a certain MIB subtree (that is, users are not allowed to access any node of the MIB subtree).

You can define MIB access rights in the access table by group name, security model, and security level.

### 5.3.3 Web Configuration

1. Enable SNMP, as shown below.

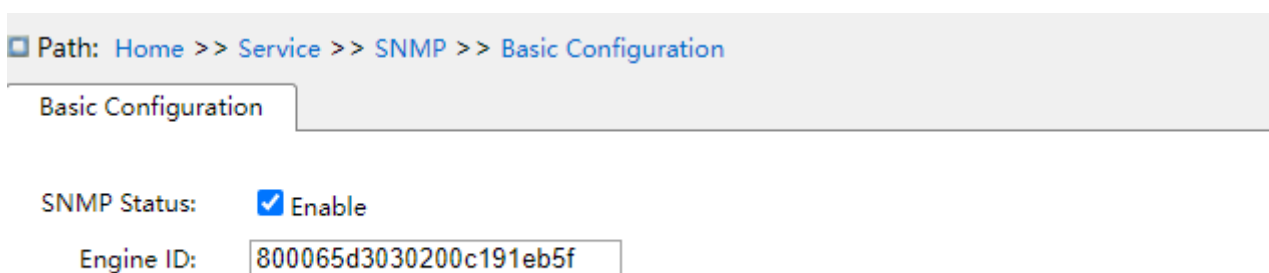

Figure 51 enable SNMP

#### SNMP Status

Configuration options: enable/disable

Default configuration: disable

Function: enable or disable SNMP.

#### Engine ID

Configuration range: hexadecimal number is even, can not be all 0 or F, the value range of

even number is 10~64.

Function: Configure SNMP v3 system engine ID, the user corresponding to the device ID in the user table will be clear when the engine ID is modified.

2. Configure trap, as shown below.

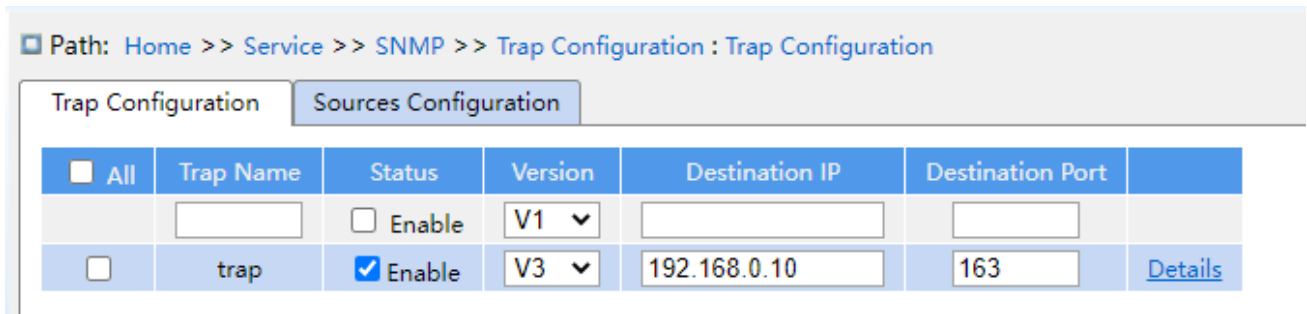

Figure 52 Configure Trap

**Trap name**

Configuration range: 1~32 characters

Function: configure trap name.

**Status**

Configuration options: enable/disable

Default configuration: disable

Function: enable or disable trap, the switch sends the corresponding trap message to the server if enable.

**Version**

Configuration options: SNMP v1/SNMP v2c/SNMP v3

Default configuration: SNMP v1

Function: configurate the trap message version number that the switch sends to the server.

**Destination IP**

Configuration format: A.B.C.D

Function: Configure the server address where the trap message is received.

**Destination port**

Configuration range: 1~65535

Default configuration: 162

Function: Configure the port number that sends the trap message.

3. Click on the trap configuration item details to see the trap configuration details, as shown below.

Path: Home >> Service >> SNMP >> Trap Configuration : Trap Configuration -> Detail[trap]

Detail[trap] Sources Configuration

[<<Back](#)

Trap Name:

Status:  Enable

Version:

Community:

Destination IP:

Destination Port:

Inform Mode:  Enable

Inform Timeout(sec):

Inform Retry Times:

Engine ID:

Security Name:

Figure 53 trap detail information

**Trap name**

Configuration range: 0~32 characters

Default configuration: public

Function: Configure the community name that is carried in the sending trap message.

**Inform Mode**

Configuration options: enable/disable

Default configuration: disable

Function: Whether the server sends a reply message to the switch after receiving the trap message.

**Inform Timeout**

Configuration range: 0~2147s

Default configuration: 3s

Function: Configure the trap message sending timeout; after the switch sends the trap message, if no response from the server within that time, resend the trap message.

### **Inform Retry Times**

Configuration range: 0~255

Default configuration: 5

Function: Configure the number of times the trap message is timed out. If the cumulative number of sending times exceeds the configuration value, the server still does not reply, then the trap message sends failed.

### **Engine ID**

Configuration range: hexadecimal number is even, can not be all 0 or F, the value range of even number is 10~64.

Function: Configure the security engine ID value which is carried in the SNMP v3 trap message.

### **Security Name**

Default configuration: None

Function: When using SNMP V3 Trap, it is necessary to bind to the V3 username.

4. Configure trap event, as shown below.

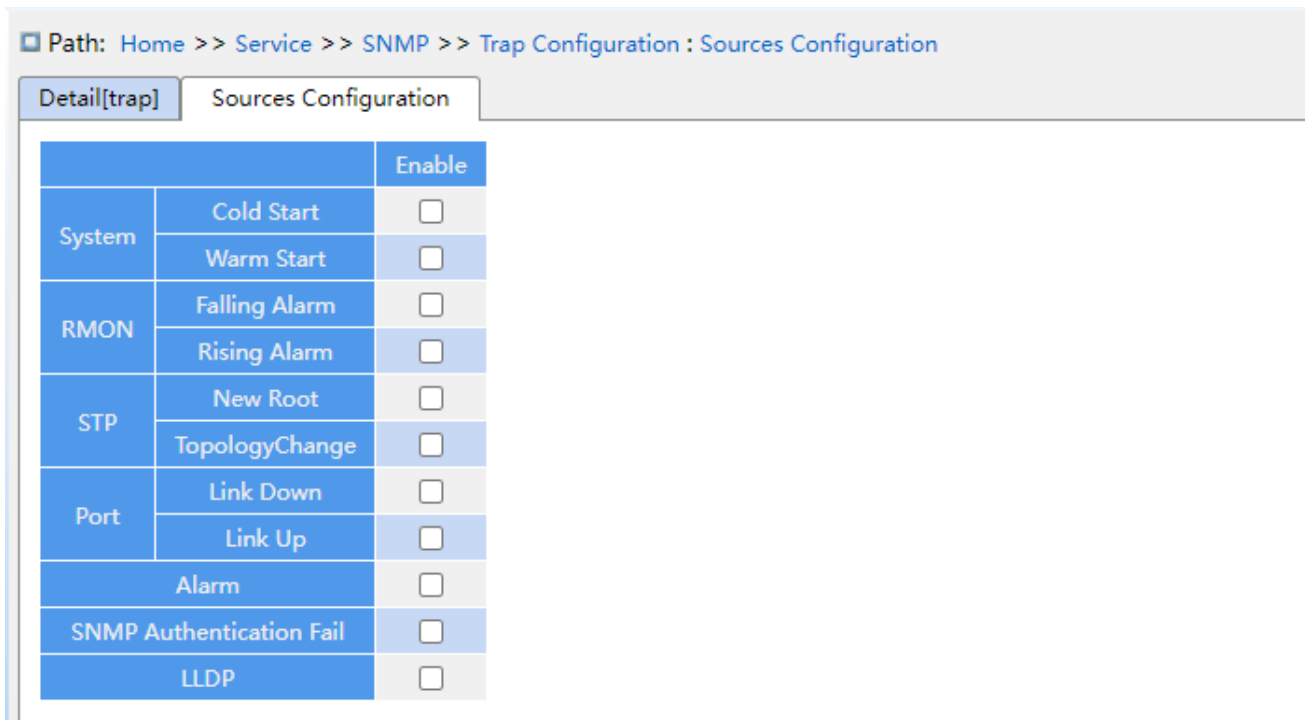

Figure 54 trap source configuration

**System warm start/cold start**

Configuration options: enable/disable

Default configuration: disable

Function: Whether to send trap message when the system is warm start / cold start.

**RMON falling alarm/rising alarm**

Configuration options: enable/disable

Default configuration: disable

Function: Whether to send a trap message when the RMON generates a faulting alarm / rising alarm.

**STP new root/ topology change**

Configuration options: enable/disable

Default configuration: disable

Function: Whether to send the trap message when the state of STP changes.

**Port link up/down**

Configuration options: enable/disable

Default configuration: disable

Function: Whether to send trap message of port up/down when port status changes.

**Alarm**

Configuration options: enable/disable

Default configuration: disable

Function: When there is alarm information, whether to send trap message.

**SNMP authentication fail**

Configuration options: enable/disable

Default configuration: disable

Function: If snmp authentication fails, whether to send trap message.

**LLDP**

Configuration options: enable/disable

Default configuration: disable

Function: Whether to send LLDP trap message when the neighbor status changes.

5. Configure user name table, as shown below.

Path: Home >> Service >> SNMP >> V3 Detail : V3 User Name Table

V3 User Name Table | V3 Group Table | V3 View Table | V3 Access Table

All	Security Name	Engine ID	Security Level	Authentication Protocol	Authentication Password	Privacy Protocol	Privacy Password
<input type="checkbox"/>		800065d3030200c191eb5f	NoAuthNoPriv	MD5		DES	
<input type="checkbox"/>	test	800065d3030200c191eb5f	AuthNoPriv	MD5	*****	--	--
<input type="checkbox"/>	test1	800065d3030200c191eb5f	AuthPriv	MD5	*****	DES	*****

Figure 55 configure SNMPv3 user name table

**Security Name**

Configuration range: 1~32 characters

Function: Create user name.

**Engine ID**

Configuration range: hexadecimal number is even, can not be all 0 or F, the value range of even number is 10~64.

Function: Configure the security engine ID value which is carried in the SNMP v3 trap message.

**Security Level**

Configuration options: No Auth No Priv/Auth No Priv/Auth Priv

Function: Configure the security level of the current user.

Description: No Auth No Priv requires neither authentication nor encryption, Auth No Priv

need to authenticate but not to encrypt, Auth Priv requires both authentication and encryption.

**Authentication Protocol**

Configuration options: MD5/SHA

Function: Select an authentication protocol. When selecting auth no priv/auth priv at the security level, you need to configure the authentication protocol and authentication password.

**Authentication Password**

Configuration range: 8~40 characters (MD5 protocol) 8~32 characters (SHA protocol)

Function: Create authentication password.

**Privacy Protocol**

Configuration options: DES/AES

Function: Select a privacy protocol. The privacy protocol and password need to be configured when selecting Auth, Priv at the security level.

**Privacy Password**

Configuration range: 8~32 characters

Function: Create privacy password.

Up 16 users can be configured.

5. Configure group table, as shown below.

Path: Home >> Service >> SNMP >> V3 Detail : V3 Group Table

V3 User Name Table   V3 Group Table   V3 View Table   V3 Access Table

Index	Group Name	Security Name	Security Model
1	default_ro_group	public	V2C ▾
2	default_rw_group	private	V2C ▾
3	<input type="text"/>	<input type="text"/>	usm ▾
4	<input type="text"/>	<input type="text"/>	usm ▾
5	<input type="text"/>	<input type="text"/>	usm ▾
6	<input type="text"/>	<input type="text"/>	usm ▾
7	<input type="text"/>	<input type="text"/>	usm ▾
8	<input type="text"/>	<input type="text"/>	usm ▾
9	<input type="text"/>	<input type="text"/>	usm ▾
10	<input type="text"/>	<input type="text"/>	usm ▾
11	<input type="text"/>	<input type="text"/>	usm ▾
12	<input type="text"/>	<input type="text"/>	usm ▾
13	<input type="text"/>	<input type="text"/>	usm ▾

Apply

Figure 56 Configure SNMPv3 group table

**Group name**

Configuration range: 1~32 characters

Function: configure the name of group table, the users with the same group name belong to the same group.

**Security model**

Default configuration: SNMP v3

Function: Select the security model of current group (that is SNMP version number) , SNMPv3 use USM (security model based on user) technology, This option force on the SNMP V3 model currently.

**Security name**

Configuration range: Created user name, 1~32 characters

Function: configure security name, the security name should match the user name in the user table. Users with the same group name belong to the same group.

Up 32 group tables can be configured.

6. Configure view table, as shown below.



Path: Home >> Service >> SNMP >> V3 Detail : V3 View Table

V3 User Name Table | V3 Group Table | **V3 View Table** | V3 Access Table

Index	View Name	View Type	OID
1	default_view	included	.1
2	<input type="text"/>	included	<input type="text"/>
3	<input type="text"/>	included	<input type="text"/>
4	<input type="text"/>	included	<input type="text"/>
5	<input type="text"/>	included	<input type="text"/>
6	<input type="text"/>	included	<input type="text"/>
7	<input type="text"/>	included	<input type="text"/>
8	<input type="text"/>	included	<input type="text"/>
9	<input type="text"/>	included	<input type="text"/>
10	<input type="text"/>	included	<input type="text"/>
11	<input type="text"/>	included	<input type="text"/>
12	<input type="text"/>	included	<input type="text"/>
13	<input type="text"/>	included	<input type="text"/>

Apply

Figure 57 Configure SNMPv3 view table

**View Name**

Configuration range: 1~32 characters

Function: Configure view name.

**View Type**

Configuration options: included/excluded

Function: Included indicates that the current view includes all the nodes of the MIB subtree, excluded indicates that the current view does not include any nodes of the MIB subtree.

**OID sub node**

Function: Configure MIB subtree, indicated by the OID of the root node of the subtree.

Up 16 view tables can be configured.



**Note:**

The view table by default in the switch default\_view include all nodes of a subtree.

7. Configure access table, as shown below.

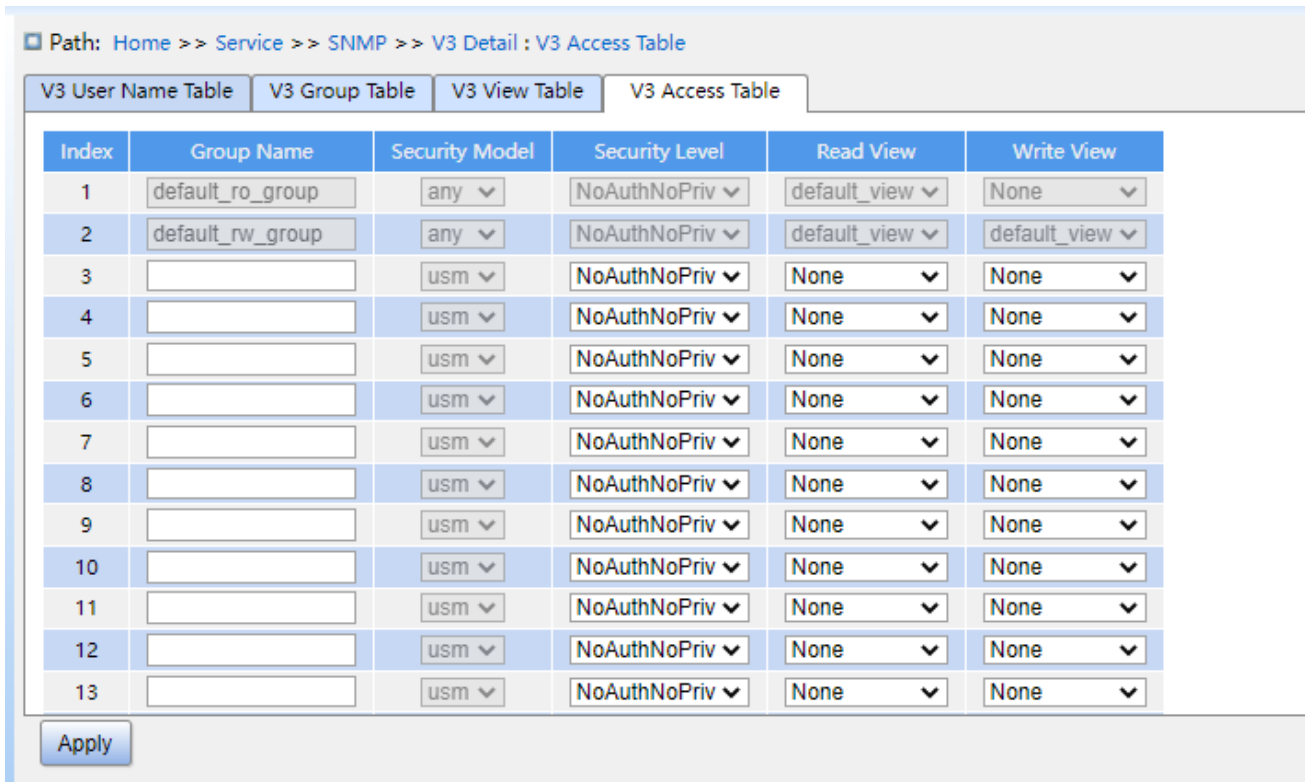

Figure 58 Configure SNMPv3 access table

**Group Name**

Configuration range: Created group name, 1~32 characters

Description: All users in a group have the same access authority.

**Security Model**

Default configuration: any /use

Function: Select the security model for the current group access switch (that is SNMP version number), SNMPv3 use USM (security model based on user) technology. Any refers to use any security model. Group name, security model configuration should be consistent with group name and security model in group table.

**Security level**

Configuration options: No Auth No Priv/Auth No Priv/Auth Priv

Function: Configure the security level of current group.

Description: No Auth No Priv requires neither authentication nor encryption, Auth No Priv need to authenticate but not to encrypt, Auth Priv requires both authentication and encryption. When encryption is needed, the authentication / encryption protocol, the authentication / encryption password on the NMS side should be consistent with the

configuration of the user table, then the node information of the switch can be accessed successfully.

The security level of No Auth No Priv、Auth No Priv、Auth Priv increment in turn, a low level of security allows it can be accessed by a high level of security. If a group is configured the security level as Auth No Priv, users with a security level as Auth No Priv and Auth Priv in this group can successfully access the switch if both the authentication / encryption protocol and the authentication / encryption password are correct, but users with a security level as No Auth No Priv, cannot access the switch.

### Read View

Configuration options: default\_view/None/Created view name

Function: Select read only view name.

### Write View

Configuration options: default\_view/None/Created view name

Function: Select read and write view name.

Up 16 access tables can be configured.



#### Note:

The default access tables in the switch {default\_ro\_group, any, No Auth, No Priv, default\_view, None}、 {default\_rw\_group, any, No Auth, No Priv, default\_view, default\_view}.

---

## 5.3.4 Typical Configuration Example

SNMP management server is connected to the switch through Ethernet. The IP address of the management server is 192.168.0.23, and that of the switch is 192.168.0.2. User 1111 and user 2222 manage the Agent through SNMP v3. Security level is set to Auth No Priv, and the switch can perform read-only operation on all node information of the Agent. When an alarm occurs, the Agent sends trap v3 messages to the NMS proactively, as shown in Figure 59.

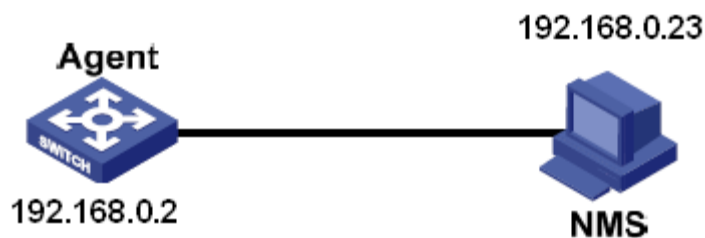

Figure 59 SNMP v3 Configuration Example

Configuration on the Agent:

1. Enable SNMP and v3 state, as shown in Figure 51.

2. Configure the SNMP v3 user table

Set a user name to 1111, security level to Auth, Priv, authentication protocol to MD5, authentication password to aaaaaaaa, privacy protocol to DES, and privacy password to xxxxxxxx.

Set another user name to 2222, security level to Auth, Priv, authentication protocol to SHA, authentication password to bbbbbbbb, privacy protocol to AES, and privacy password to yyyyyyyy, as shown in Figure 55.

3. Create group, set security model to usm, and add user 1111 and user 2222 to the group, as shown in Figure 56.

4. Configure the SNMP v3 access table

Set the group name to group, security model to use, security level to Auth, No Priv, read view to default\_view, and write view to None, as shown in Figure 58.

5. Enable the global trap mode, as shown in Figure 52.

6. Create trap entry 222, enable trap mode; set the trap version to SNMP v3, destination IP address to 192.168.0.23. Select system, interface, authentication, and switch all trap events, and adopt default settings for the other parameters.

If you want to monitor and manage Agent devices, run the corresponding management software in NMS.

## 5.4 SSH Configuration

### 5.4.1 Introduction

SSH (Secure Shell) is a network protocol for secure remote login. It encrypts all transmitted data to prevent information disclosure. When data is encrypted by SSH, users can only use command lines to configure switches.

The switch supports the SSH server function and allows the connection of multiple SSH users that log in to the switch remotely through SSH.

### 5.4.2 Implementation

In order to realize the SSH secure connection in the communication process, the server and the client experience the following five stages:

Version negotiation stage: currently, SSH consists of two versions: SSH1 and SSH2. The two parties negotiate a version to use.

Key and algorithm negotiation stage: SSH supports multiple types of encryption algorithms. The two parties negotiate an algorithm to use.

Authentication state: the SSH client sends an authentication request to the server and the server authenticates the client.

Session request stage: the client sends a session request to the server after passing the authentication.

Session stage: the client and the server start communication after passing the session request.

### 5.4.3 Web Configuration

1. Enable SSH protocol, as shown below.



Figure 60 Enable SSH Protocol

### SSH Status

Configuration options: Enabled/Disabled

Default configuration: Enabled

Function: Enable/Disable SSH protocol. If it is enabled, the switch works as the SSH server.

### 5.4.4 Typical Configuration Example

The Host works as the SSH client to establish a local connection with switch, as shown in Figure 61;

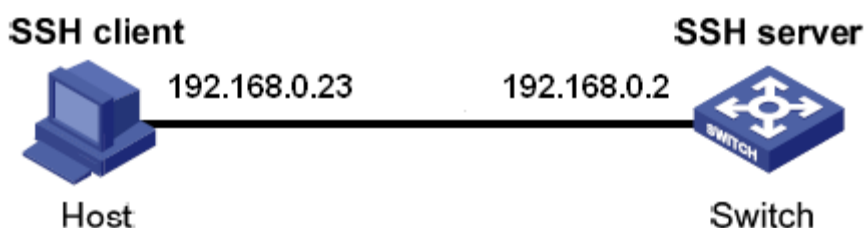

Figure 61 SSH Configuration Example

1. Enable SSH protocol, as shown in Figure 60;
2. Establish the connection with the SSH server. First, run the PuTTY.exe software, as shown in Figure 62; input the IP address of the SSH server "192. 168.0.2" in the space of Host Name (or IP address).

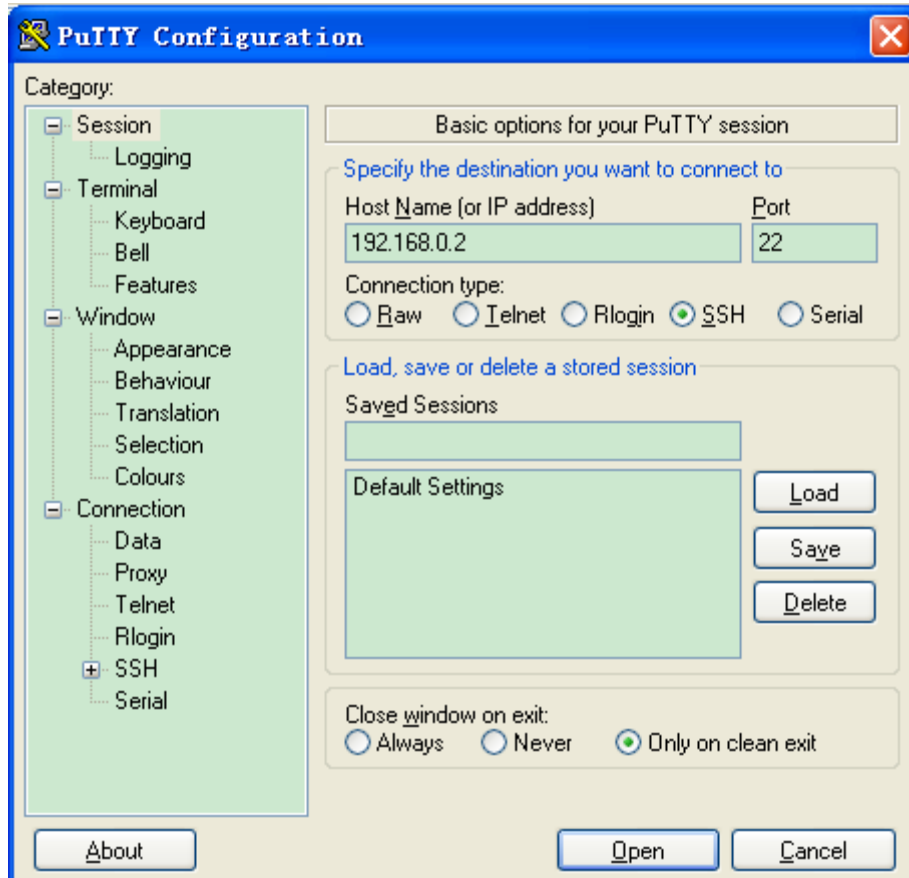

Figure 62 SSH Client Configuration

3. Click <Open> button and following warning message appears shown in Figure 63, click the <Yes(Y)> button.



Figure 63 Warning Message

4. Input the user name "admin" and the password "123" to enter the switch configuration interface, as shown in Figure 64.



Figure 64 Login Interface of the SSH Authentication



## 5.5 TACACS+ Configuration

### 5.5.1 Introduction

Terminal Access Controller Access Control System (TACACS+) is a TCP-based application. It adopts the client/server mode to implement the communication between Network Access Server (NAS) and TACACS+ server. The client runs on the NAS and user information is managed centrally on the server. The NAS is the server for users but client for the server. Figure 65 shows the structure.

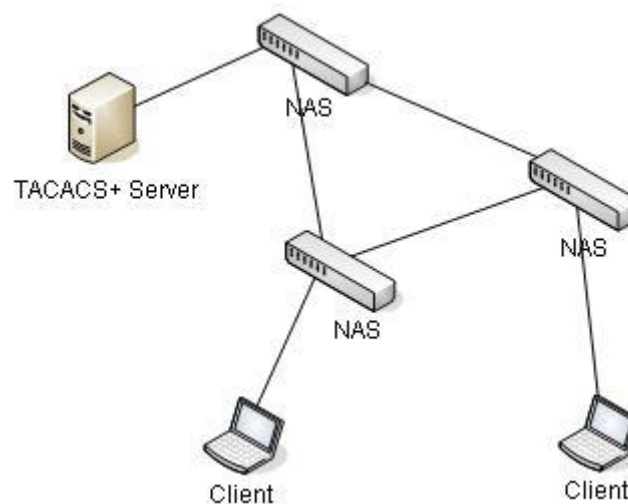

Figure 65 TACACS+ Structure

The protocol authenticates, authorizes, and charges terminal users that need to log in to the device for operations. The device serves as the TACACS+ client, and sends the user name and password to the TACACS+ server for authentication. The server receives TCP connection requests from users, responds to authentication requests, and checks the legitimacy of users. If a user passes authentication, it can log in to the device for operations.

### 5.5.2 Web Configuration

1. Configure the TACACS+ server, as shown below.

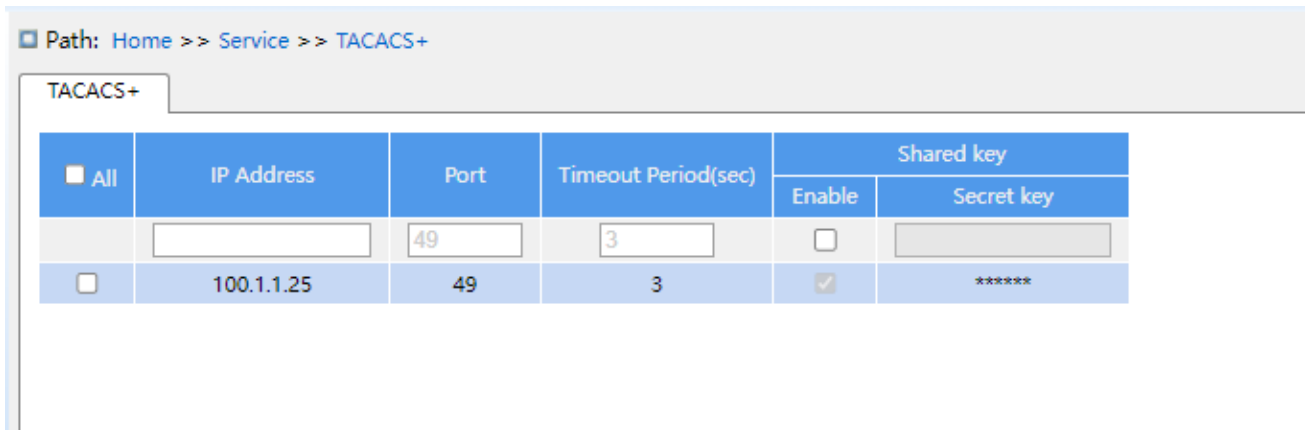

Figure 66 TACACS+ Server Configuration

**IP Address**

Function: Configure the IP address or hostname of TACACS+ server. A maximum of 5 TACACS+ server can be configured.

**Port**

Configuration range: 0~65535

Default configuration: 49

Function: Set TCP port of the TACACS+ server for authentication.

**Timeout Period(sec)**

Configuration range: 1~1000s

Function: Set the overtime for response from the TACACS+ server. After sending a TACACS+ request packet, if the device still receives no response from the TACACS+ server after the specified time, authentication fails, and the device will consider the TACACS+ server is invalid.

**Share Key**

Configuration range: 1~63 characters

Function: Set the key to improve the communication security between client and TACACS+ server. The two parties share the key to verify the legitimacy of packets. Both parties can receive packets from each other only when the keys are the same. Therefore, make sure the configured key is the same as the key on the TACACS+ server.

### 5.5.3 Typical Configuration Example

As shown in Figure 67, TACACS+ server can authenticate and authorize users by the switch. The server IP address is 192.168.0.23, and the shared key used when switch and server exchange packets is aaa.

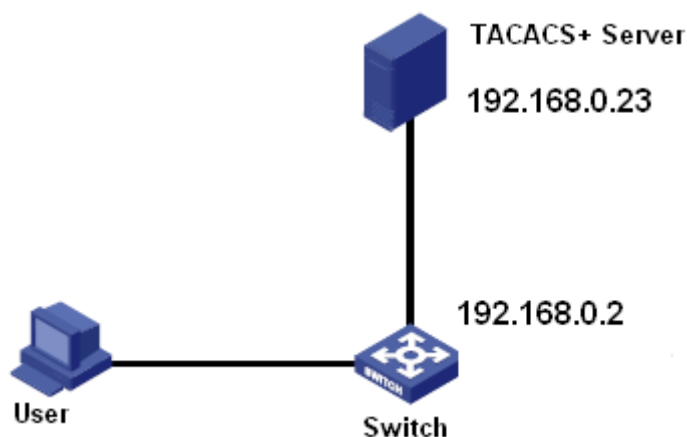

Figure 67 TACACS+ Authentication Example

1. TACACS+ server configuration. Set the server IP address to 192.168.0.23 and key to aaa, as shown in Figure 66.
2. When logging in to the switch through Web, select "Local", while logging in to the switch through telnet, select "Tacacs+", as shown in Figure 13.
3. Configure username and password "bbb", encrypt key "aaa" on TACACS+ server.
4. When logging in to the switch through Web, input the username "admin" and password "123" to pass the local authentication.
5. When logging in to the switch through Telnet, input the username and password "bbb" to pass the TACACS+ authentication.

## 5.6 RADIUS Configuration

### 5.6.1 Introduction

RADIUS (Remote Authentication Dial-In User Service) is a distributed information exchange protocol. It defines UDP-based RADIUS frame format and information transmission mechanism, protecting networks from unauthorized access. RADIUS is usually used in networks that require high security and remote user access.

RADIUS adopts client/server mode to achieve communication between the NAS (Network Access Server) and the RADIUS server. The RADIUS client runs on the NAS. The RADIUS server provides centralized management for user information. The NAS is the server for users but client for the RADIUS server. Figure 68 shows the structure.

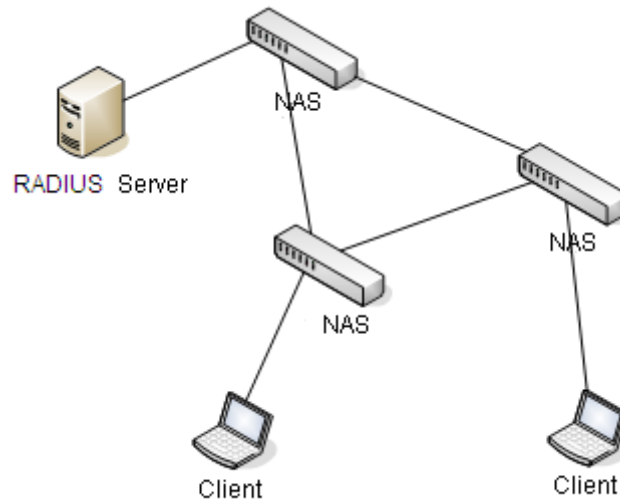

Figure 68 RADIUS Structure

The protocol authenticates terminal users that need to log in to the device for operation. Serving as the RADIUS client, the device sends user information to the RADIUS server for authentication and allows or disallows users to log in to the device according to authentication results.

### 5.6.2 Web Configuration

1. Configure the RADIUS server, as shown below.

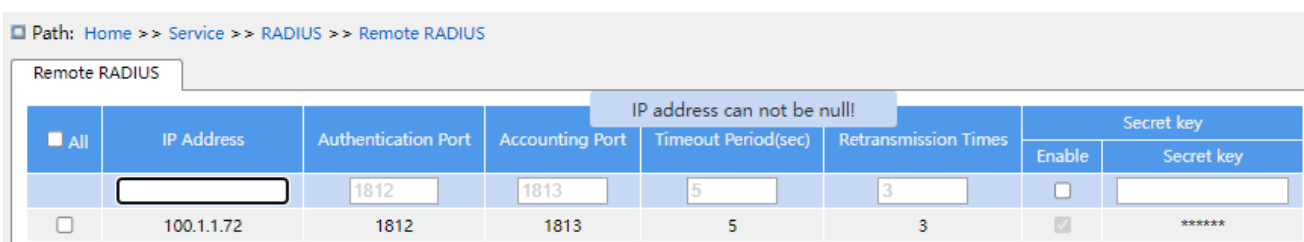

Figure 69 Configure the RADIUS Server

#### IP Address

Function: Configure the IP address or hostname of RADIUS server. A maximum of 5 RADIUS server can be configured.

#### Authentication Port

Configuration range: 0~65535

Default configuration: 1812

Function: Set UDP port of the RADIUS server for authentication.

### **Accounting Port**

Configuration range: 0~65535

Default configuration: 1813

Function: Set UDP port of the RADIUS server for accounting. Since RADIUS uses different UDP ports for receiving and sending authentication and accounting messages, different port numbers must be configured for authentication and accounting.

### **Timeout Period(sec)**

Configuration range: 1~1000s

Function: Set the overtime for response from the RADIUS server. After sending a RADIUS request packet, the device will retransmit a RADIUS request packet if it still receives no response from the RADIUS server after the specified time.

### **Retransmission Times**

Configuration range: 1~1000

Function: Set the maximum retransmission attempts for RADIUS request packets. If the device still receives no response packets from the RADIUS server after maximum retransmission attempts, authentication fails, and the device will consider the RADIUS server is invalid.

### **Secret Key**

Configuration range: 0~63 characters

Function: Set the key to improve the communication security between client and RADIUS server. The two parties share the key to verify the legitimacy of packets. Both parties can receive packets from each other only when the keys are the same. Therefore, make sure the configured key is the same as the key on the RADIUS server.



#### **Note:**

The priority of “Timeout Period”, “Retransmission Times”, and “Secret Key” in RADIUS server configuration is higher than those in global configuration.

---

2. RADIUS Global Configuration, as shown below.

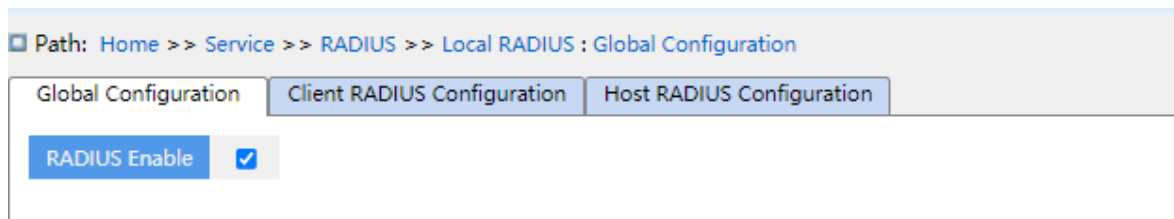

Figure 70 global configuration

**RADIUS Enable**

Configuration options: Enable/Disable

Default configuration: Disable

Function: Whether enable local RADIUS to be used by other devices as RADIUS servers.

3. Client RADIUS Configuration, as shown below.

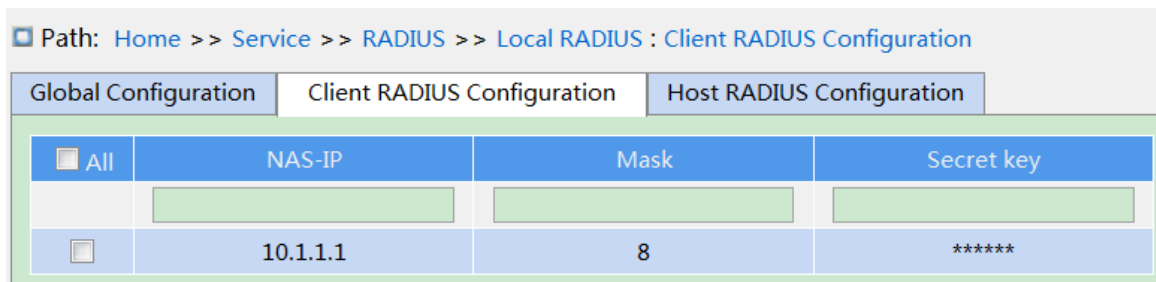

Figure 71 Client RADIUS configuration

**NAS-IP**

Function: Configure IP address or IP address segment of RADIUS client.

**Mask**

Configuration range: 1-32

Function: Configure network segment of RADIUS client, the IP address of the same network segment only configure one segment.

**Secret key**

Configuration range: 1~63 characters

Function: Configure the shared key the device and the radius client to verify the validity of the message. Only if the key is the same, then accept and respond the message each other, so the shared key configured on the device must be same with the key value on the RADIUS client.

4. Host RADIUS Configuration, as shown below.

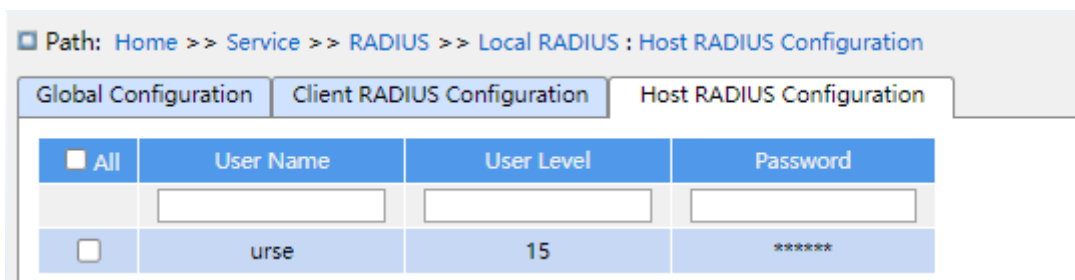

Figure 72 Host RADIUS configuration

**User Name**

Configuration range: 1-31 characters

Function: Configure RADIUS user name.

**User Level**

Configuration range:1~15

Function: Configure the user authority level. Users with different authority levels have different access authority.

**Password**

Configuration range: 1-31 characters

Function: Configure the login password of user.

**5.6.3 Typical Configuration Example**

As shown in Figure 73, IEEE802.1X is enabled on port 1 of the switch. Then users can log in to the switch through port 1 after passing the authentication on the RADIUS server. The IP address of the server is 192.168.0.23. The key for packet exchange between the switch and the server is aaa.

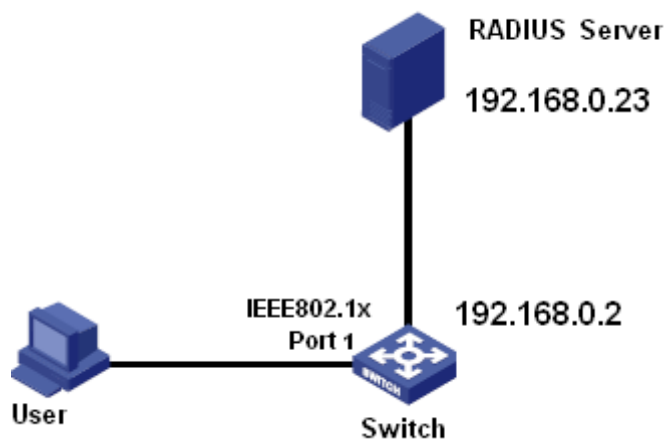

Figure 73 RADIUS Authentication Example

1. Set the IP address of the authentication server to 192.168.0.23 and password to aaa, as shown in Figure 69.
2. IEEE802.1x settings: enable IEEE802.1X globally. Set authentication type to radius, admin state of port 1 to port-based 802.1X, keep default settings for the other parameters.
3. Set both the user name and password on the RADIUS Server to ccc, encrypt key to aaa.
4. Install and run 802.1x client software on a PC. Enter ccc for the user name and password. Then the user can pass the authentication and access the switch through port 1.

## 5.7 RMON

### 5.7.1 Introduce

Based on SNMP architecture, Remote Network Monitoring (RMON) allows network management devices to proactively monitor and manage the managed devices. An RMON network usually involves the Network Management Station and Agents. The NMS manages Agents and Agents can collect statistics on various types of traffic on these ports.

RMON mainly provides statistics and alarm functions. With the statistics function, Agents can periodically collect statistics on various types of traffic on these ports, such as the number of packets received from a certain network segment during a certain period. Alarm function is that Agents can monitor the values of specified MIB variables. When a value reaches the alarm threshold (such as the number of packets reaches the specified value),



Agent can automatically record alarm events in RMON log, or send a Trap message to the management device.

### 5.7.2 RMON Groups

RMON (RFC2819) defines multiple RMON groups. The series devices support statistics group, history group, event group, and alarm group in public MIB.

#### ➤ Statistics group

With the statistics group, the system collects statistics on all types of traffic on ports and stores the statistics in the Ethernet statistics table for further query by the management device. The statistics includes the number of network collisions, CRC error packets, undersized or oversized packets, broadcast and multicast packets, received bytes, and received packets. After creating a statistics entry on a specified port successfully, the statistics group counts the number of packets on the port and the statistics is a continuously accumulated value.

#### ➤ History group

History group requires the system to periodically sample all kinds of traffic on ports and saves the sampling values in the history record table for further query by the management device. The history group counts the statistics values of all kinds of data in the sampling interval.

#### ➤ Event group

Event group is used to define event indexes and event handling methods. Events defined in the event group is used in the configuration item of alarm group. An event is triggered when the monitored device meets the alarm condition. Events are addressed in the following ways:

Log: logs the event and related information in the event log table.

Trap: sends a Trap message to the NMS and inform the NMS of the event.

Log-Trap: logs the event and sends a Trap message to the NMS.

None: indicates no action.

#### ➤ Alarm group

RMON alarm management can monitor the specified alarm variables. After alarm entries are

defined, the system will acquire the values of monitored alarm variables in the defined period. When the value of an alarm variable is larger than or equal to the upper limit, a rising alarm event is triggered. When the value of an alarm variable is smaller than or equal to the lower limit, a falling alarm event is triggered. Alarms will be handled according to the event definition.



**Caution:**

If a sampled value of alarm variable exceeds the threshold multiple times in a same direction, then the alarm event is only triggered only the first time. Therefore the rising alarm and falling alarm are generated alternately.

### 5.7.3 Web Configuration

1. Configure statistics table, as shown below.

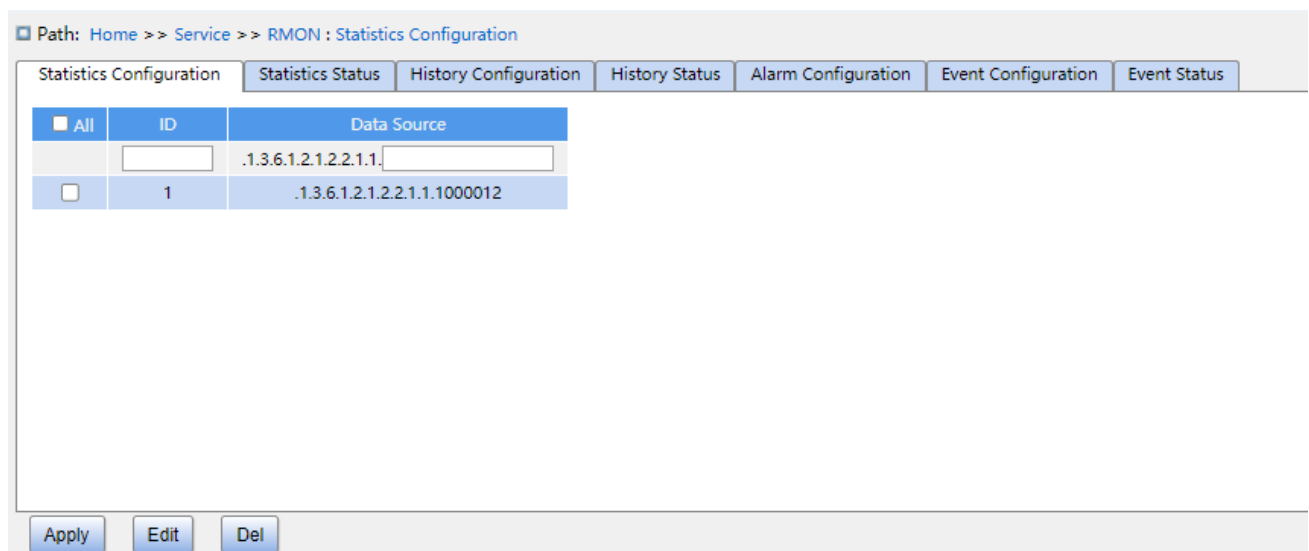

Figure 74 Configure RMON Statistics Table

**ID**

Configuration range: 1~65535

Function: Configure the number of the statistics entry. Statistics group supports up to 128 entries.

**Data Source**

Configuration range: 10000portid

Function: Select the port whose statistics are to be collected.

2. View statistics group status, as shown below.

ID	Data Source	Drop	Octets	Pkts	Broadcast	Multicast	CRC Errors	Undersize	Oversize	Frag.	Jabb.	Coll.	64Bytes	65-127	128-255	256-511	512-1023	1024-1518
1	1000016	1122201	2325178457	308292901	1386693	12116	0	0	0	0	0	0	1597619	13300323	26998244	53996460	107992975	104407280

Figure 75 Overview statistics group status

Drop: the number of packets dropped by the port.

Octets: the number of bytes received by the port.

Pkts: the number of packets received by the port.

Broadcast: the number of broadcast packets received by the port.

Multicast: the number of multicast packets received by the port.

CRC Errors: the number of CRC error packets with a length of between 64 and 9600 bytes received by the port.

Undersize: the number of packets with less than 64 bytes received by the port.

Oversize: the number of packets with more than 9600 bytes received by the port.

Frag.: the number of CRC error packets with less than 64 bytes received by the port.

Jabb.: the number of CRC error packets with more than 9600 bytes received by the port.

Coll.: the number of collisions received by the port under half duplex mode.

64 Bytes: the number of packets with a length of 64 bytes received by the port.

65-127: the number of packets with a length of between 65 and 127 bytes received by the port.

128-255: the number of packets with a length of between 128 and 255 bytes received by the port.

256-511: the number of packets with a length of between 256 and 511 bytes received by the port.

512-1023: the number of packets with a length of between 512 and 1023 bytes received by the port.

1024-1588: the number of packets with a length of between 1024 and 1588 bytes received by the port.



**Note:**

The oversize depends on the parameter "Maximum Frame Size" in Port Configuration, as

shown in 7.1 Port Configuration. In above example, the oversize is 9600 bytes.

3. Configure history table, as shown below.

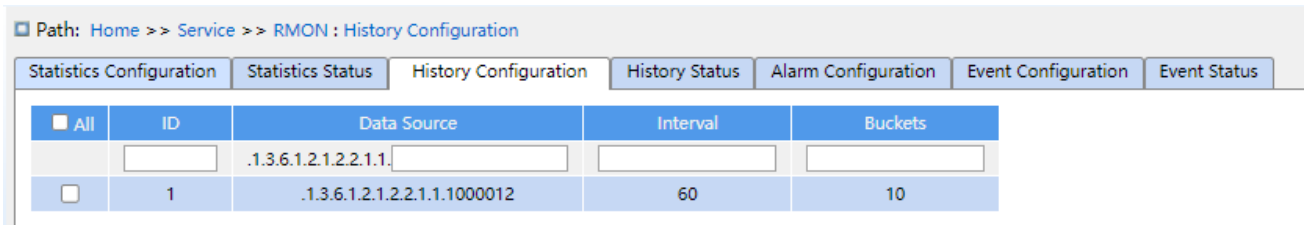

Figure 76 Configure History Table

**ID**

Configuration range: 1~65535

Function: Configure the number of the history entry. History group supports up to 256 entries.

**Data Source**

Configuration options: 100000portid

Function: Select the port whose information is to be sampled.

**Interval**

Configuration range: 1~3600s

Function: Configure the sampling period of the port.

**Buckets**

Configuration range: 1~65535

Default configuration: 50

Function: Configures the number of latest sampling values of port information stored in RMON.

4. View history group status, as shown below.

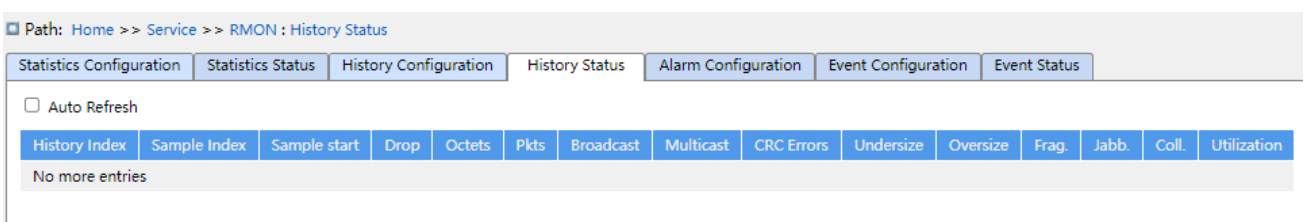

Figure 77 Overview History Group Status

5. Configure event table, as shown below.

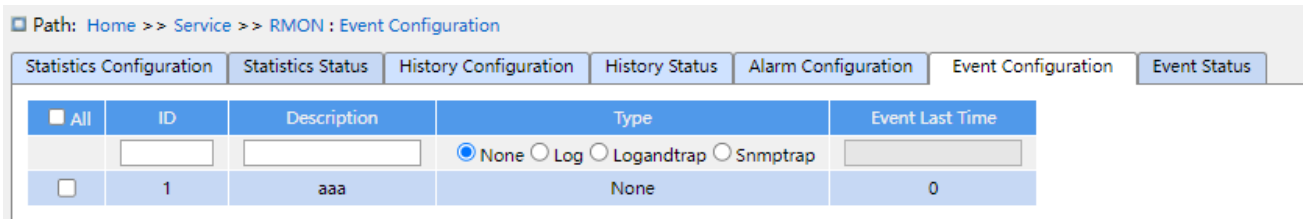

Figure 78 Configure Event Table

**ID**

Configuration range: 1~65535

Function: Configure the index number of the event entry. Event group supports up to 128 entries.

**Description**

Configuration range: 1~127 characters

Function: Describe the event.

**Type**

Configuration options: none/log/snmptap/logandtrap

Default configuration: none

Function: Configure the event type for alarms, that is, the processing mode towards alarms.

**Event Last Time**

Function: Displays the value of sysUpTime when the event is used last time.

6. View event group status, as shown below.

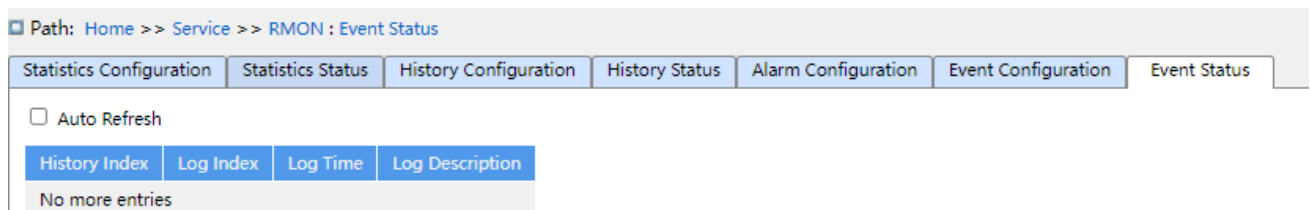

Figure 79 Overview Event Group Status

7. Configure alarm table, as shown below.

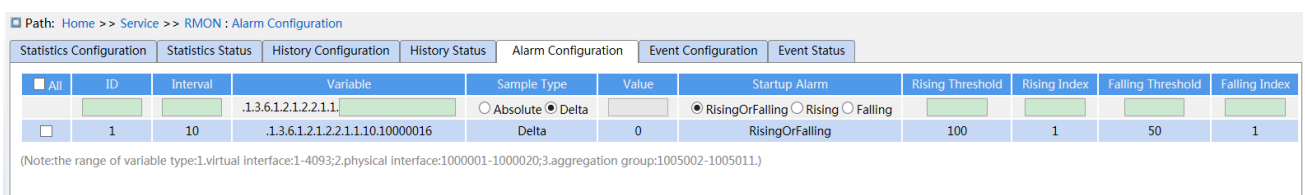

Figure 80 Configure Alarm Table

**ID**

Configuration range: 1~65535

Function: Configure the number of the alarm entry. Alarm group supports up to 256 entries.

**Interval**

Configuration range: 1~2147483647s

Function: Configure the sampling period.

**Variable**

Configuration Format: A.10000portid

Configuration range: A: 10~21

Function: Select the port MIB information to be monitored.

InOctets: A=10, the number of bytes received by the port.

InUcastPkts: A=11, the number of unicast packets received by the port.

InNUcastPkts: A=12, the number of broadcast and multicast packets received by the port.

InDiscards: A=13, the number of packets dropped by the port.

InErrors: A=14, the number of error packets received by the port.

InUnknownProtos: A=15, the number of unknown packets received by the port.

OutOctets: A=16, the number of bytes sent by the port.

OutUcastPkts: A=17, the number of unicast packets sent by the port.

OutNUcastPkts: A=18, the number of broadcast and multicast packets sent by the port.

OutDiscards: A=19, the number of discarded packets sent by the port.

OutErrors: A=20, the number of error packets sent by the port.

OutQLen: A=21, The length of packets in port outlet queue.

**Sample Type**

Configuration options: Absolute/Delta

Default configuration: Delta

Function: choose the method of comparing the sampling value and threshold.

Description: Absolute: directly compare each sampling value to threshold; Delta: the sampling value minus the previous sampling value, then use the difference to compare with threshold.

**Startup Alarm**

Configuration options: Rising/Falling/Rising or Falling

Default configuration: Rising or Falling

Function: choose the alarm type.

### **Rising Threshold**

Configuration range: 1~2147483647

Function: Set a rising threshold. When the sampling value exceeds the rising threshold and the alarm type is Rising Alarm or RisOrFallAlarm, the alarm will be triggered and the rising event index will be activated.

### **Rising Index**

Configuration range: 1~65535

Function: Set the index of a rising event. It is the handling method of a rising alarm.

### **Falling Threshold**

Configuration range: 1~2147483647

Function: Set a falling threshold. When the sampling value is lower than the falling threshold and the alarm type is Falling Alarm or RisOrFallAlarm, the alarm will be triggered and the falling event index will be activated.

### **Falling Index**

Configuration range: 1~65535

Function: Set the index of a falling event. It is the handling method of a falling alarm.

## 6 Alarm

### 6.1 Introduction

This series switches support the following types of alarms:

- Power alarm: If the function is enabled, then an alarm will be generated for a single power input.
- IP/MAC conflict alarm: If the function is enabled, then an alarm will be triggered for an IP/MAC conflict.
- Memory / CPU usage alarm: If this function is enabled, an alarm is generated when the CPU / memory usage exceeds the specified threshold.
- Port alarm: If this function is enabled, an alarm is triggered when the port is in link down state.
- Port traffic alarm: If this function is enabled, an alarm is generated when the incoming / outgoing traffic rate of a port exceeds the specified threshold.

### 6.2 Web Configuration

1. Basic alarm configuration and display, as shown below.

Alarm Type	Enable	Status	Threshold	Margin Value	Detection Time
Power Alarm	<input type="checkbox"/>	Disable	--	--	--
IP/MAC Conflict Alarm	<input checked="" type="checkbox"/>	Disable	--	--	300 (180~600s)
CPU Availability Alarm	<input checked="" type="checkbox"/>	Disable	85%	5%	--
Memory Availability Alarm	<input checked="" type="checkbox"/>	Disable	85%	5%	--

Figure 81 Basic Alarm

#### Power Alarm

Configuration options: Enable/Disable

Default configuration: Disable

Function: Enable/Disable Power Alarm.

#### Status



Configuration options: Normal/Alarm

Function: View power alarm status.

Alarm: For redundant power products, one of the power modules fails or works abnormally and an alarm is triggered.

Normal: For single power products, the power module supplies power normally; for redundant power product, two power modules both supply power normally.

### **IP, MAC Conflict**

Configuration options: Enable/Disable

Default configuration: Enable

Function: Enable/Disable IP/MAC conflict alarm.

### **Status**

Configuration options: Conflict / No Conflict

Description: When an IP/MAC conflict occurs, Conflict is displayed; otherwise, No Conflict is displayed.

### **Check Time**

Configuration range: 180~600s

Default configuration: 300s

Function: Configure the interval for detecting IP/MAC conflicts.

### **CPU/Memory Availability Alarm**

Configuration options: Enable/Disable

Default configuration: Enable

Function: Enable/Disable CPU/Memory Availability Alarm.

### **Threshold (%)**

Configuration range: 50~100

Default configuration: 85

Function: Set the CPU/memory usage threshold. When the CPU/memory usage of the switch is higher than the threshold, an alarm is generated.

### **Margin Value (%)**

Configuration range: 1~20

Default configuration: 5

Function: Set the CPU/memory usage margin value.

Description: If the CPU/memory usage fluctuates around the threshold, alarms may be generated and cleared repeatedly. To prevent this phenomenon, you can specify a margin value (5% by default). The alarm will be cleared only if the CPU/memory usage is lower than the threshold by the margin value or more. For example, the memory usage threshold is set to 60% and the margin value is set to 5%. If the memory usage of the switch is lower than or equal to 60%, no alarm is generated. If the memory usage is higher than 60%, an alarm will be generated. The alarm will be cleared only if the memory usage is equal to or lower than 55%.

2. Configure and display port alarm, as shown below.

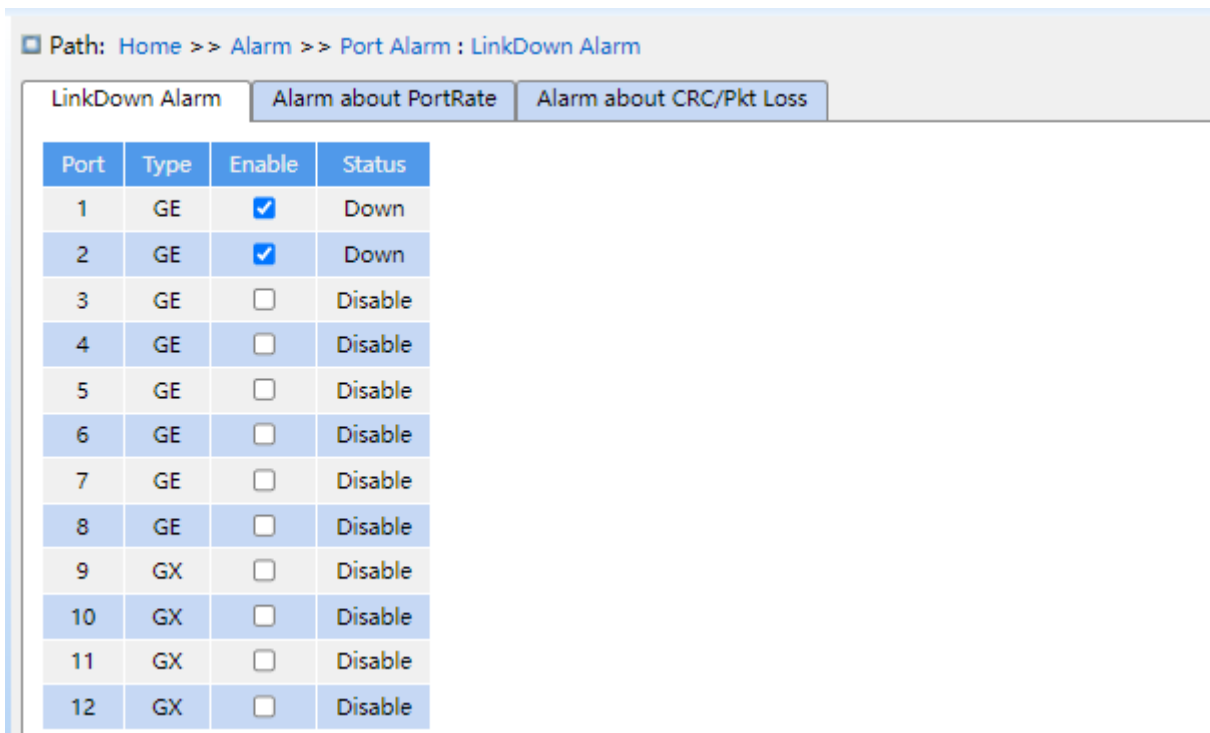

Figure 82 Port Alarm

### Port Alarm Configuration

Configuration options: Disable/Enable

Default configuration: Disable

Function: Enable/Disable port alarm.

### Status

Configuration options: Link Up/Link Down

Description: Link Up means the port is in connection state and supports normal

communication. Link Down means the port is disconnected or in abnormal connection (communication failure).

3. Configure and display port traffic alarm, as shown below.

Path: Home >> Alarm >> Port Alarm : Alarm about PortRate

LinkDown Alarm    Alarm about PortRate    Alarm about CRC/Pkt Loss

Port	Type	Input Rate			Output Rate		
		Enable	Status	Threshold	Enable	Status	Threshold
1	GE	<input checked="" type="checkbox"/>	Normal	1 bps	<input checked="" type="checkbox"/>	Normal	1 bps
2	GE	<input checked="" type="checkbox"/>	Normal	10 kbps	<input checked="" type="checkbox"/>	Normal	10 kbps
3	GE	<input type="checkbox"/>	Disable	1 bps	<input type="checkbox"/>	Disable	1 bps
4	GE	<input type="checkbox"/>	Disable	1 bps	<input type="checkbox"/>	Disable	1 bps
5	GE	<input type="checkbox"/>	Disable	1 bps	<input type="checkbox"/>	Disable	1 bps
6	GE	<input type="checkbox"/>	Disable	1 bps	<input type="checkbox"/>	Disable	1 bps
7	GE	<input type="checkbox"/>	Disable	1 bps	<input type="checkbox"/>	Disable	1 bps
8	GE	<input type="checkbox"/>	Disable	1 bps	<input type="checkbox"/>	Disable	1 bps
9	GX	<input type="checkbox"/>	Disable	1 bps	<input type="checkbox"/>	Disable	1 bps
10	GX	<input type="checkbox"/>	Disable	1 bps	<input type="checkbox"/>	Disable	1 bps
11	GX	<input type="checkbox"/>	Disable	1 bps	<input type="checkbox"/>	Disable	1 bps
12	GX	<input type="checkbox"/>	Disable	1 bps	<input type="checkbox"/>	Disable	1 bps

Figure 83 Port Traffic Alarm Configuration

**input rate alarm/output rate alarm**

Configuration options: Enable/Disable

Default configuration: Disable

Function: Enable/Disable port traffic alarm.

**Threshold**

Configuration range: 1 to 1000000000bps or 1 to 1000000kbps.

Function: Configure the threshold for the port traffic.

**Alarm Status**

Configuration options: Disable/Alarm/ Normal

Function: View the port traffic status. Alarm means the incoming / outgoing traffic rate exceeds the threshold and triggers alarm.

4. Configure and display CRC error / packet loss alarm, as shown below.

Path: Home >> Alarm >> Port Alarm : Alarm about CRC/Pkt Loss

LinkDown Alarm | Alarm about PortRate | Alarm about CRC/Pkt Loss

Port	Type	Packet Loss			CRC		
		Enable	Status	Threshold	Enable	Status	Threshold
1	GE	<input checked="" type="checkbox"/>	Normal	1 pps	<input checked="" type="checkbox"/>	Normal	1 pps
2	GE	<input checked="" type="checkbox"/>	Normal	10 pps	<input checked="" type="checkbox"/>	Normal	10 pps
3	GE	<input type="checkbox"/>	Disable	1 pps	<input type="checkbox"/>	Disable	1 pps
4	GE	<input type="checkbox"/>	Disable	1 pps	<input type="checkbox"/>	Disable	1 pps
5	GE	<input type="checkbox"/>	Disable	1 pps	<input type="checkbox"/>	Disable	1 pps
6	GE	<input type="checkbox"/>	Disable	1 pps	<input type="checkbox"/>	Disable	1 pps
7	GE	<input type="checkbox"/>	Disable	1 pps	<input type="checkbox"/>	Disable	1 pps
8	GE	<input type="checkbox"/>	Disable	1 pps	<input type="checkbox"/>	Disable	1 pps
9	GX	<input type="checkbox"/>	Disable	1 pps	<input type="checkbox"/>	Disable	1 pps
10	GX	<input type="checkbox"/>	Disable	1 pps	<input type="checkbox"/>	Disable	1 pps
11	GX	<input type="checkbox"/>	Disable	1 pps	<input type="checkbox"/>	Disable	1 pps
12	GX	<input type="checkbox"/>	Disable	1 pps	<input type="checkbox"/>	Disable	1 pps

Figure 84 CRC Error/ Pkt Loss Alarm Configuration

**CRC/Pkt Loss Alarm**

Configuration options: Enable/Disable

Default configuration: Disable

Function: Enable/Disable CRC/ Pkt loss alarm.

**Threshold**

Configuration range: 1 to 1000000pps.

Function: Configure the threshold for the port CRC/ Pkt loss alarm.

**Alarm Status**

Configuration options: Disable/Alarm/ Normal

Function: View the port CRC/ Pkt loss status. Alarm means the port CRC/ Pkt loss exceeds the threshold and triggers alarm.

6. Configure and display Ring alarm, as shown below.

Path: Home >> Alarm >> Alarm about Ring

Alarm About DRP

Ring ID	Enable	Status
1	<input type="checkbox"/>	Disable

Figure 85 Ring Alarm Configuration

**Alarm About DRP**

Configuration options: Disable/Enable

Default configuration: Disable

Function: Enable/Disable DRP alarm.

**Alarm Status**

Configuration options: Disable/Alarm/---

Function: View the DRP status. --- means DRP is closed. Alarm means DRP is open or in abnormal state.

7. Configure and display SFP port RX Power alarm, as shown below.

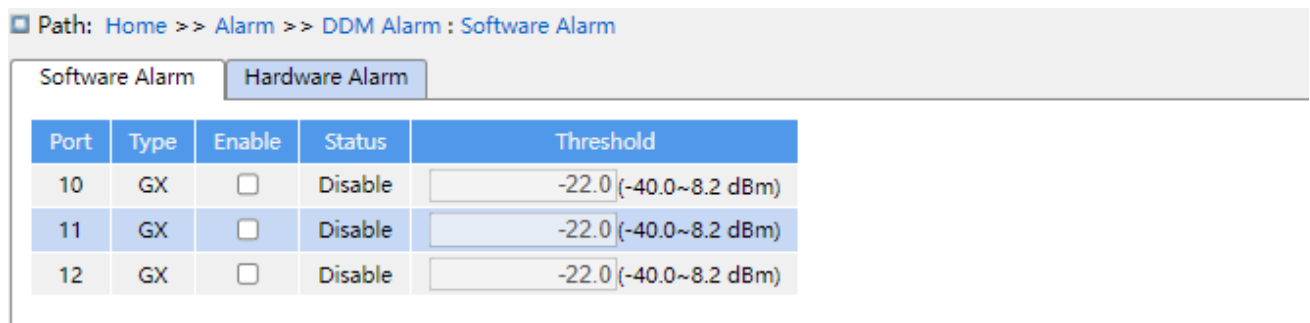

Figure 86 SFP port RX Power alarm

**Software Alarm**

Options: Enable/ Disable

Default: Disable

Function: Enable/ Disable SFP RX power alarm.

**Threshold**

Range: -40~8.2 (unit: dBm)

Default: -22.0dBm

Function: Configure the threshold for the SFP port RX power alarm.

**Alarm Status**

Options: Normal/Alarm

Description: After the function is enabled, alarm means the Rx power for SFP port less than the specified threshold and triggers alarm.

8. Configure and display transceiver alarm, as shown below.

Path: Home >> Alarm >> DDM Alarm : Hardware Alarm

Software Alarm    Hardware Alarm

DDM Alarm Enable:     Enable

Port	Type	RX Power Alarm			TX Power Alarm		
		Current Value	High Alarm State	Low Alarm State	Current Value	High Alarm State	Low Alarm State
10	GX	-40.5	Normal	Normal	-4.3	Normal	Normal
11	GX	-40.5	Normal	Normal	-11.7	Normal	Normal
12	GX	-40.5	Normal	Normal	-7.3	Normal	Normal

Figure 87 Transceiver Alarm Configuration

### DDM Alarm Enable

Options: Enable /Disable

Default: Disable

Function: Enable /Disable transceiver alarm. A optical power low alarm is generated when the monitored value of optical power at the SFP port is less than the low alarm threshold; a optical power high alarm is generated when the monitored value of optical power at the SFP port exceeds the high alarm threshold.



**Caution:**

The low and high optical power threshold depend on hardware, and can not be configured in software.

## 7 Function Management

### 7.1 Port Configuration

1. Configure port status, port rate, flow control etc. information, as shown below.

Path: Home >> Function Management >> Port Configuration : Port Mode

Port	Type	Alias	Admin State	Link Status	Auto Negotiate	Speed	Full	Flow Control
1	GE	<input type="text"/>	<input checked="" type="checkbox"/>	Down	<input checked="" type="checkbox"/>	<input type="radio"/> 10M <input type="radio"/> 100M <input checked="" type="radio"/> 1000M	<input checked="" type="checkbox"/>	<input type="checkbox"/>
2	GE	<input type="text"/>	<input checked="" type="checkbox"/>	Down	<input checked="" type="checkbox"/>	<input type="radio"/> 10M <input type="radio"/> 100M <input checked="" type="radio"/> 1000M	<input checked="" type="checkbox"/>	<input type="checkbox"/>
3	GE	<input type="text"/>	<input checked="" type="checkbox"/>	Down	<input checked="" type="checkbox"/>	<input type="radio"/> 10M <input type="radio"/> 100M <input checked="" type="radio"/> 1000M	<input checked="" type="checkbox"/>	<input type="checkbox"/>
4	GE	<input type="text"/>	<input checked="" type="checkbox"/>	Down	<input checked="" type="checkbox"/>	<input type="radio"/> 10M <input type="radio"/> 100M <input checked="" type="radio"/> 1000M	<input checked="" type="checkbox"/>	<input type="checkbox"/>
5	GE	<input type="text"/>	<input checked="" type="checkbox"/>	Down	<input checked="" type="checkbox"/>	<input type="radio"/> 10M <input type="radio"/> 100M <input checked="" type="radio"/> 1000M	<input checked="" type="checkbox"/>	<input type="checkbox"/>
6	GE	<input type="text"/>	<input checked="" type="checkbox"/>	Down	<input checked="" type="checkbox"/>	<input type="radio"/> 10M <input type="radio"/> 100M <input checked="" type="radio"/> 1000M	<input checked="" type="checkbox"/>	<input type="checkbox"/>
7	GE	<input type="text"/>	<input checked="" type="checkbox"/>	Up	<input checked="" type="checkbox"/>	<input type="radio"/> 10M <input type="radio"/> 100M <input checked="" type="radio"/> 1000M	<input checked="" type="checkbox"/>	<input type="checkbox"/>
8	GE	<input type="text"/>	<input checked="" type="checkbox"/>	Down	<input checked="" type="checkbox"/>	<input type="radio"/> 10M <input type="radio"/> 100M <input checked="" type="radio"/> 1000M	<input checked="" type="checkbox"/>	<input type="checkbox"/>
9	GX	<input type="text"/>	<input checked="" type="checkbox"/>	Down	<input checked="" type="checkbox"/>	<input type="radio"/> 100M <input checked="" type="radio"/> 1000M	<input checked="" type="checkbox"/>	<input type="checkbox"/>
10	GX	<input type="text"/>	<input checked="" type="checkbox"/>	Down	<input checked="" type="checkbox"/>	<input type="radio"/> 100M <input checked="" type="radio"/> 1000M	<input checked="" type="checkbox"/>	<input type="checkbox"/>
11	GX	<input type="text"/>	<input checked="" type="checkbox"/>	Down	<input checked="" type="checkbox"/>	<input type="radio"/> 100M <input checked="" type="radio"/> 1000M	<input checked="" type="checkbox"/>	<input type="checkbox"/>
12	GX	<input type="text"/>	<input checked="" type="checkbox"/>	Down	<input checked="" type="checkbox"/>	<input type="radio"/> 100M <input checked="" type="radio"/> 1000M	<input checked="" type="checkbox"/>	<input type="checkbox"/>

Apply

Figure 88 Configure port mode

#### Administration Status

Configuration options: Enable/disable

Default configuration: Enable

Function: Whether the port is allowed to transfer data.

Description: Open port to transfer data if enable, close port and no data is transferred if disable. This option directly affects the hardware status of the port and triggers port alarm information.

#### Link Status

Displays the connection status of the current port.

Up means port is LinkUp status and communication is normal.

Down means port is LinkDown status and communication is abnormal.

## Auto Negotiate

Configuration options: Enable/disable

Default configuration: Enable

Description: Configure port rate and duplex mode. Port rate and duplex mode can be auto negotiation or can be forced. Port rate and duplex mode automatically negotiated according to the connection status of both ports when configured to automatic negotiation mode. It is recommended that the user configure the speed and duplex mode of the port to automatic negotiation so to avoid connection problems caused by the mismatch of the port configuration as far as possible. If the user configures the port to forced rate / duplex mode, make sure the both ends connection rate / duplex mode configuration are same.



### Caution:

- The 100M electric port can be configured as auto negotiation, 10M full duplex, 10M half-duplex, 100M full duplex, 100M half-duplex.
- The Gigabit electric port can be configured as auto negotiation, 10M full duplex, 10M half-duplex, 10M full duplex, 100M and 1000M full duplex.

## Speed

Configuration options: 10M/100M or 10M/100M/1000M

Function: Configure auto negotiation speed of port.

Description: When configuring port mode to automatic negotiation, the speed of port is determined through auto negotiation with the opposite end by default. The negotiated speed can be any of the port speed range. By configuring speed, the port can negotiate only part rate, thus controlling rate negotiation.



### Caution:

Duplex capability and rate capability configuration can only be configured when auto-negotiation mode is off

## Full

Configuration options: Enable/disable



Function: Configure port auto negotiation duplex mode.

Description: full duplex means that the port can receive data while sending data; half duplex port can only send or receive data at any one time. When the port mode is configured to automatic negotiation, the port duplex mode is determined by negotiation with the end-to-end by default. The negotiated duplex mode can be either full duplex or half-duplex. By configuring the duplex, the port can negotiate only one duplex mode, thus controlling the duplex mode negotiation.

### **Flow Control**

Configuration options: Enable/disable

Default configuration: Disable

Function: Enable or disable flow control.

Description: after enable port flow control, when the port receives more traffic than the maximum value the port cache can hold, the port will inform the sending end to slow down the sending speed to prevent packet loss according to the algorithm or protocol. For half duplex mode and full duplex mode, flow control is implemented in different ways. In full duplex mode, the receiving end informs the sending end to stop sending the message by sending a special data frame (pause frame), after receiving the pause frame, the sending end will stop sending the message according to the waiting time in the frame. The half-duplex mode supports backpressure flow control, and the receiving end can intentionally create a collision or carrier signal, once the sending end detects the collision or carrier signal then adopts Backoff to delay the data transmission.

2、Port Rate, as shown below.

Path: Home >> Function Management >> Port Configuration : Port Rate

Port Mode | Port Rate | Port Storm Suppression | Port Isolate | Port Statistics | Port Rate Auto Ctrl

Port	Type	Receiving Rate	
1	GE	100	kbps
2	GE	100	kbps
3	GE	100	kbps
4	GE	0	kbps
5	GE	0	kbps
6	GE	0	kbps
7	GE	0	kbps
8	GE	0	kbps
9	GX	0	kbps
10	GX	0	kbps
11	GX	0	kbps
12	GX	0	kbps

Apply

Figure 89 Port Rate

**Receiving Rate**

Configure options: 0/16~1000000kbps/1~1000mbps

Default configuration: 0, value is 0 means disable limit rate.

Function: configure port rate limit threshold. Message data above the threshold will be discarded.

3. Port Storm Suppression configuration, as shown below.

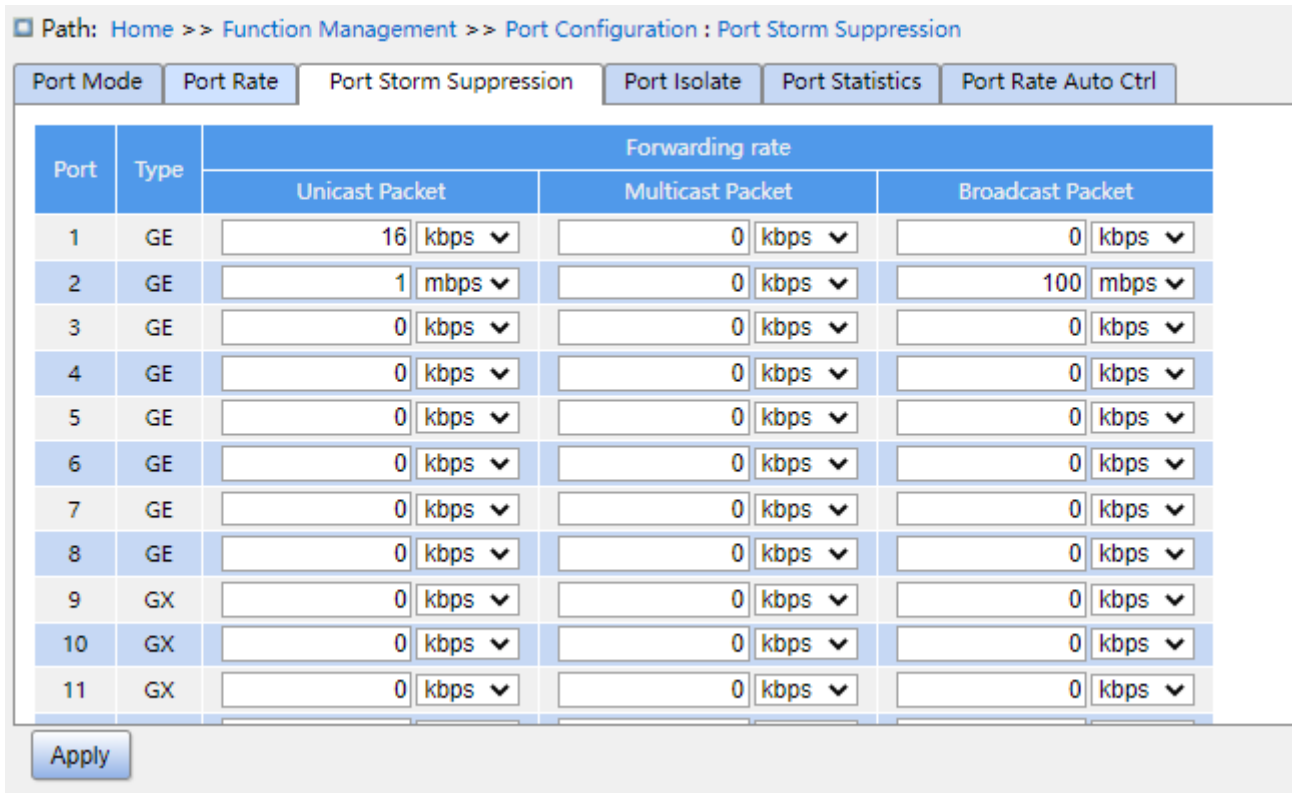

Figure 90 Port Storm Suppression

### Forwarding Rate

Configuration options: Unicast Packet/Multicast Packet/Broadcast Packet

Configuration range: 0/16~1000000kbps/1~1000mbps

Default configuration: 0 (disable storm suppression).

Function: configure port forwarding rate threshold, this type of packet data above the threshold will be discarded.

4、Port Isolate configuration, as shown below.

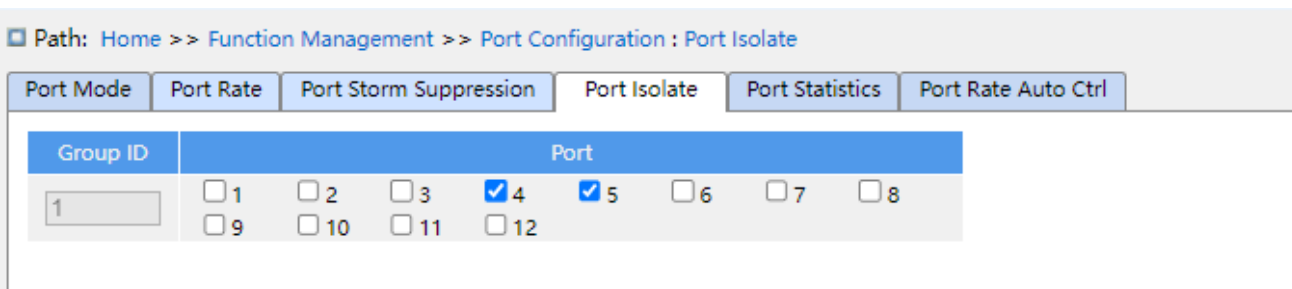

Figure 91 Port Isolate

### Enable Port Isolate

Configuration options: Enable/disable

Default configuration: Disable

Function: Enable or disable port isolate.

Note: there is only one port isolation group.

5. Port Statistics, as shown below.

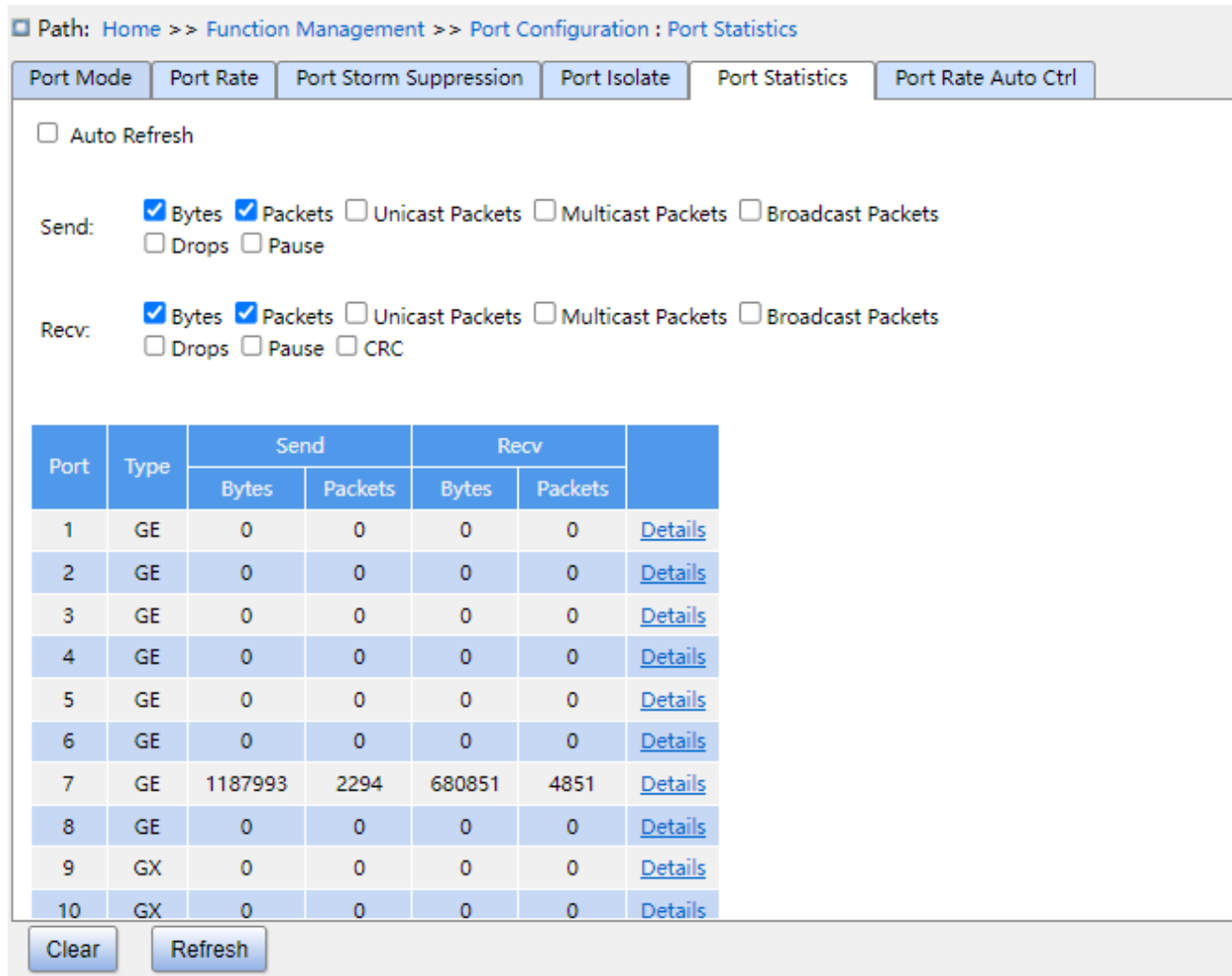

Figure 92 Port Statistics

**Bytes**

Count the number of received/sent bytes.

**Packets**

Count the number of received/sent packets.

**Unicast Packets**

Count the number of received/sent unicast packets.

**Multicast Packets**

Count the number of received/sent multicast packets.

**Broadcast Packets**

Count the number of received/sent broadcast packets.

**Drops**

Count the number of messages dropped because receiving / sending conflicts.

**Pause**

Count the number of received/sent Pause frames.

**CRC**

Count the number of received/sent CRC messages.

Click the port number corresponding details to enter the corresponding port detailed information statistics interface.

6. Port detail information statistics, as shown below.

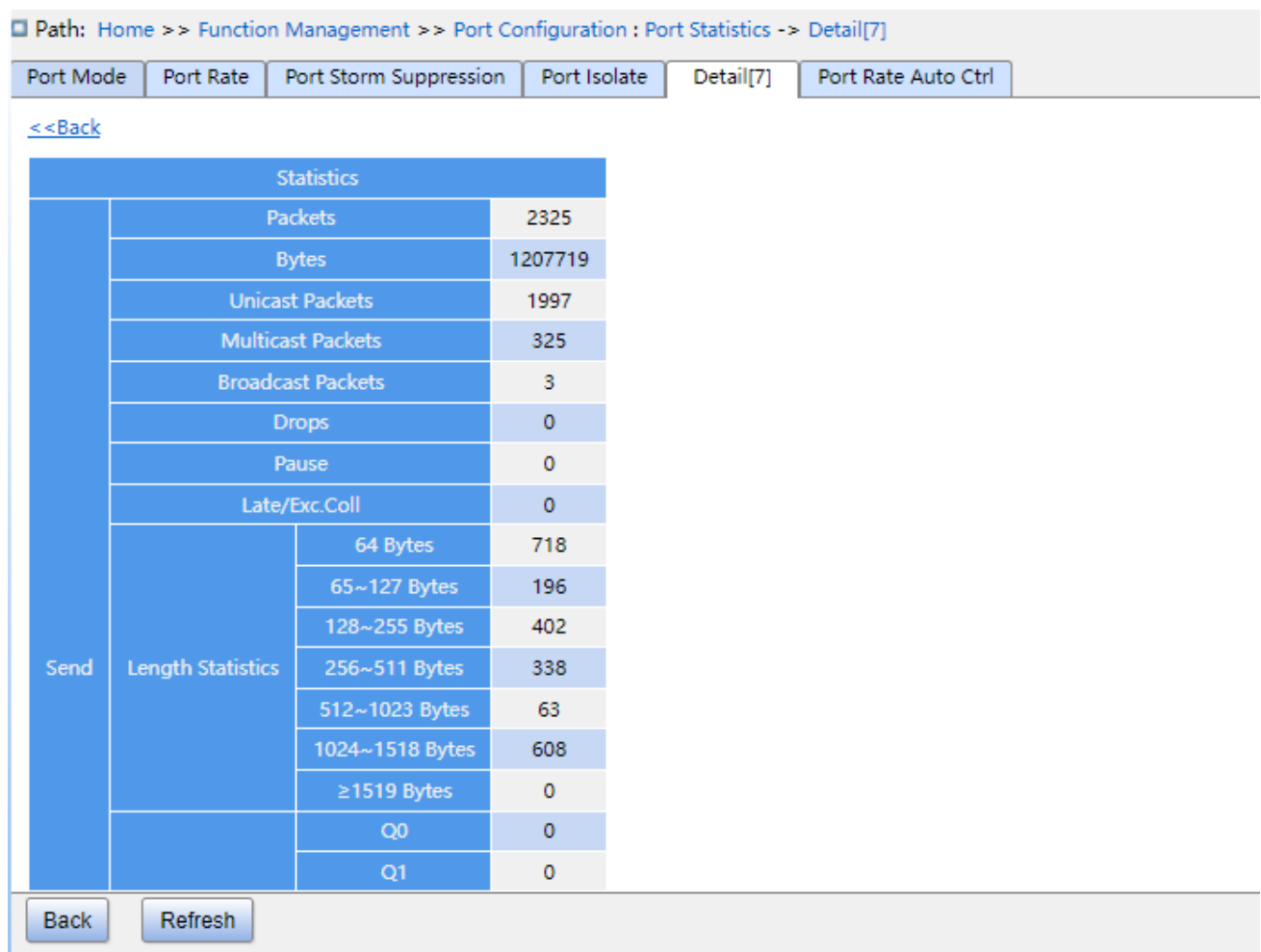

Figure 93 Port detail information statistics

7. The port is automatically speed limited as shown below.

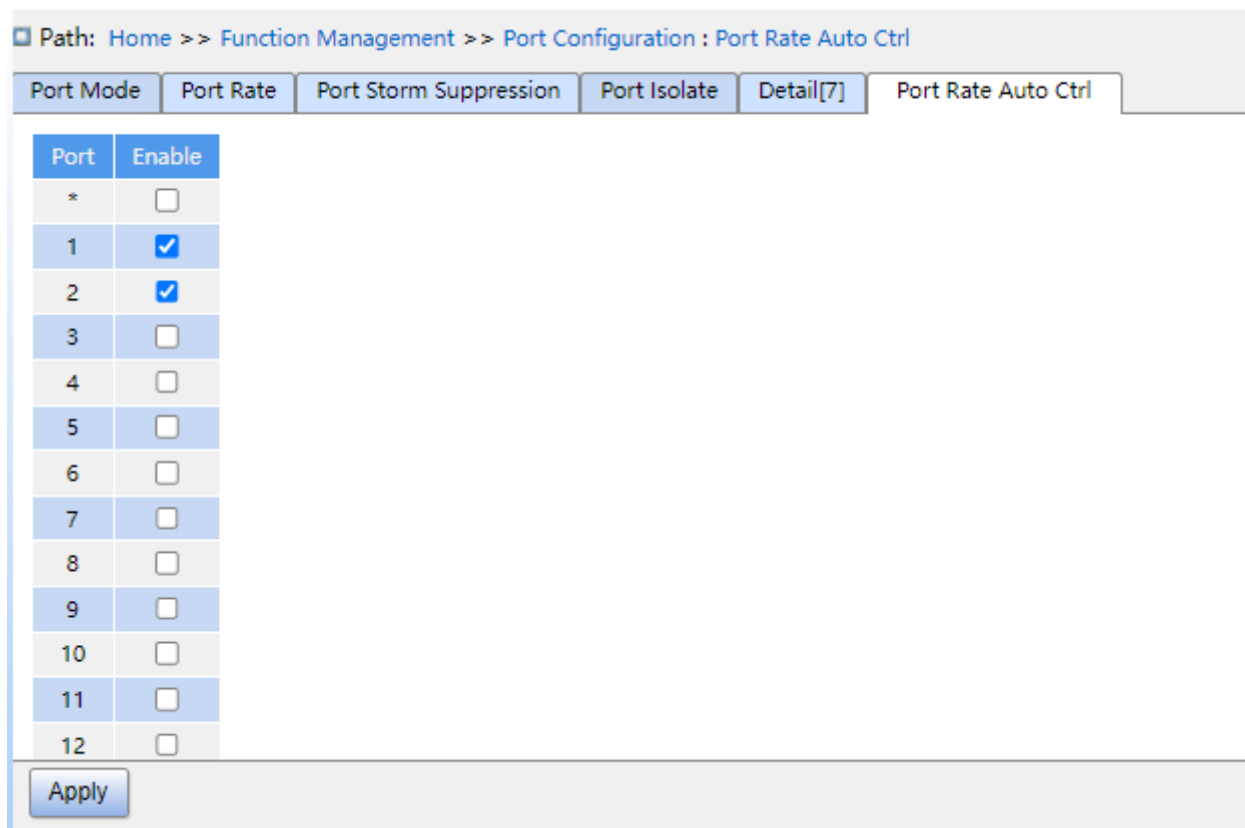

Figure 94 The port is automatically speed limited as shown below

**Port**

Configuration scope: all ports on the switch.

**Enable**

Configuration options: enable/disable

Function: Enables or disables the port auto speed limit function.

**7.2 VLAN**

**7.2.1 VLAN Configuration**

**7.2.1.1 Introduction**

One LAN can be divided into multiple logical Virtual Local Area Networks (VLANs). A device can only communicate with the devices on the same VLAN. As a result, broadcast packets are restricted to a VLAN, optimizing LAN security.

VLAN partition is not restricted by physical location. Each VLAN is regarded as a logical network. If a host in one VLAN needs to send data packets to a host in another VLAN, a router or layer-3 device must be involved.

### 7.2.1.2 Principle

To enable network devices to distinguish packets from different VLANs, fields for identifying VLANs need to be added to packets. At present, the most commonly used protocol for VLAN identification is IEEE802.1Q. Table 2 shows the structure of an 802.1Q frame.

Table 2 802.1Q Frame Structure

DA	SA	802.1Q header				Length/type	Data	FCS
		TPID	PRI	CFI	VID			

A 4-byte 802.1Q header, as the VLAN tag, is added to the traditional Ethernet data frame.

TPID: 16 bits. It is used to identify a data frame carrying a VLAN tag. The value is 0x8100. The value of TPID specified in the 802.1Q protocol is 0x8100.

PRI: three bits, identifying the 802.1p priority of a packet.

CFI: 1 bit, specifies whether an MAC address is encapsulated in the standard format in different transmission media. The value 0 indicates that an MAC address is encapsulated in the standard format and the value 1 indicates that an MAC address is encapsulated in non-standard format.

VID: 12 bits, indicating the VLAN number. The value ranges from 1 to 4093. 0, 4094, and 4095 are reserved values.



**Note:**

- VLAN 1 is the default VLAN and cannot be manually created and deleted.
- Reserved VLANs are reserved to realize specific functions by the system and cannot be manually created and deleted.

The packet containing 802.1Q header is a tagged packet; the one without 802.1Q header is an untagged packet. All packets carry an 802.1Q tag in the switch.

### 7.2.1.3 Port-based VLAN

VLAN partition can be either port-based or MAC address-based. This series switches support port-based VLAN partition. VLAN members can be defined based on switch ports.

After a port is added to a specified VLAN, the port can forward the packets with the tag for the VLAN.

### 1. Port Mode

Ports fall into two types according to how they handle VLAN tags when they forward packets.

**Access:** In access mode, the port can be added to only one VLAN. By default, all switch ports are access ports and belong to VLAN1. Packets forwarded by an access port do not have VLAN tags. Access ports are usually used to connect to terminals that do not support 802.1Q.

**Trunk:** In trunk mode, the port can be added to many VLAN. When sending PVID packets, the Trunk port can be set whether to carry the tag. It carries the tag when sending other packets. Trunk ports are usually used to connect network transmission devices.

**Hybrid:** In hybrid mode, the port can be added to many VLAN. You can set the type of packets to be received by a Hybrid port and whether the tag is carried when the Hybrid port sends packets. The Hybrid port can be used to connect network devices and user devices. The difference between a Hybrid port and a Trunk port is as follows: The Hybrid port does not carry the tag when sending packets from multiple VLANs and the Trunk port does not carry the tag only when sending PVID packets.

### 2. PVID

Each port has a PVID. When receiving an untagged packet, a port adds a tag to the packet according to the PVID. The default PVID of all ports is 1.



**Caution:**

- When configuring the PVID of a port, select one of the VLAN IDs allowed through the port; otherwise, the port may fail to forward packets.
- When the PVID tag is added to untagged packets, you can refer to PCP and DEI settings in Figure 214 for the default PRI and CFI values of a port.

Table 3 shows how the switch processes received and forwarded packets according to the port mode, and PVID.

Table 3 Different Processing Modes for Packets



Processing Received Packets		Processing Packets to Be Forwarded	
Untagged packets	Tagged packets	Port Mode	Packet Processing
<p>Add PVID tags to packets:</p> <ul style="list-style-type: none"> <li>➤ If the PVID is in the list of VLANs allowed through, accept the packet.</li> <li>➤ If the PVID is not in the list of VLANs allowed through, discard the packet.</li> </ul>	<ul style="list-style-type: none"> <li>➤ If the VLAN ID in a packet is in the list of VLANs allowed through, accept the packet.</li> <li>➤ If the VLAN ID in a packet is not in the list of VLANs allowed through, discard the packet.</li> </ul>	Access	Forward the packet after removing the tag.
		Trunk	<p>Forward the packet according to the “Egress Tagging” configuration:</p> <ul style="list-style-type: none"> <li>➤ Untag Port VLAN: If the VLAN ID in a packet is the same as PVID, and in the list of VLANs allowed through, forward the packet after removing the tag. If the VLAN ID in a packet is different from PVID, and in the list of VLANs allowed through, keep the tag and forward the packet.</li> <li>➤ Tag All: If the VLAN ID in a packet is in the list of VLANs allowed through, keep the tag and forward the packet.</li> </ul>
		Hybrid	<p>Forward the packet according to the “Egress Tagging” configuration:</p> <ul style="list-style-type: none"> <li>➤ Untag Port VLAN: the same as above.</li> <li>➤ Tag All: the same as above.</li> <li>➤ Untag All: If the VLAN ID in a packet is in the list of VLANs allowed through, forward the packet after removing the tag.</li> </ul>

### 7.2.1.4 Web Configuration

1. Configure port link mode, as shown below.

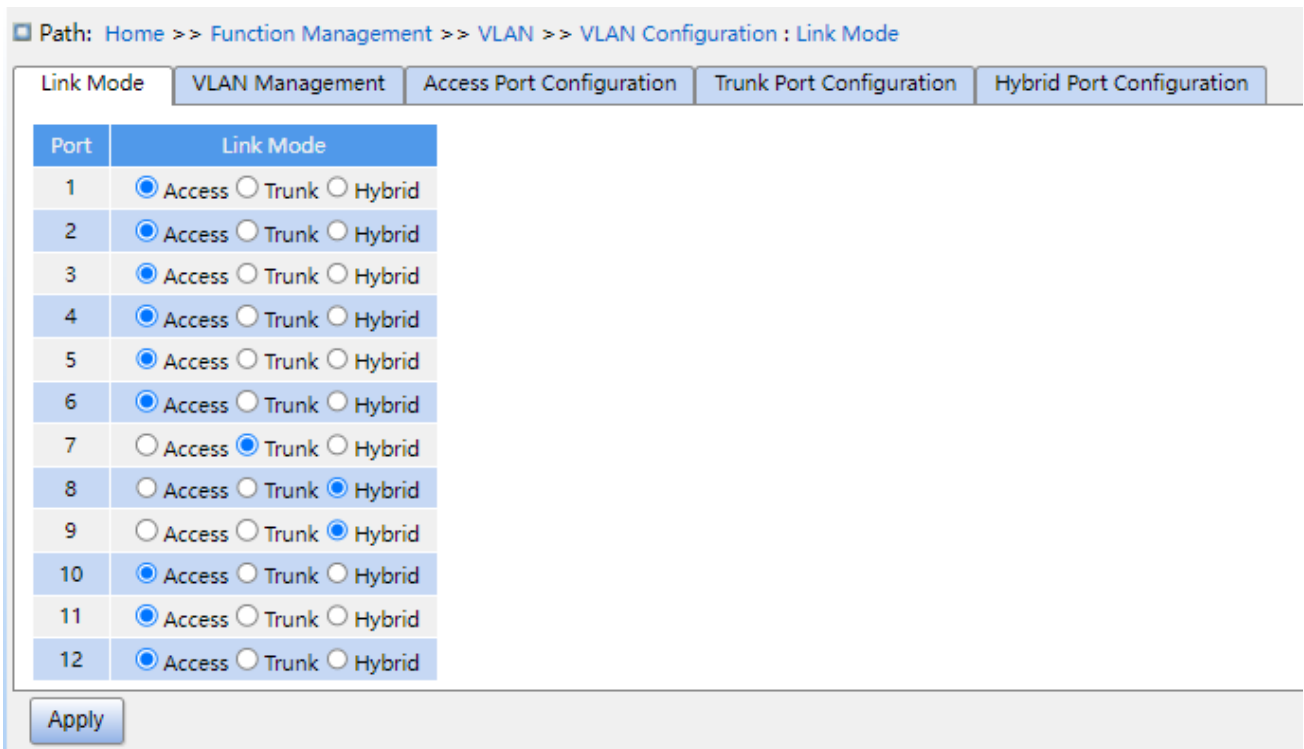

Figure 95 configurate port link mode

### Link Mode

Configuration options: Access、Trunk、Hybrid

Default configuration: Access

Function: Configure the specified port link mode.

2. VLAN Management, as shown below.

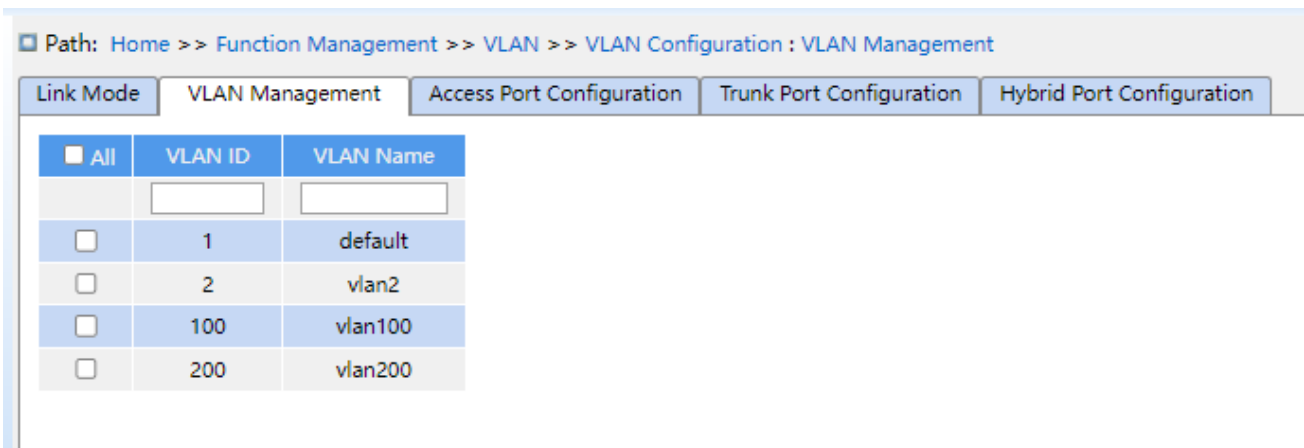

Figure 96 VLAN Management

### VLAN ID

Configuration range: 1-4094

Default configuration: 1

Function: Create VLAN.

**VLAN Name**

Configuration range: 1-32 characters, include capital letters, lowercase letters, numbers, and underscores.

Function: configure VLAN name.

3. Access Port Configuration, as shown below.

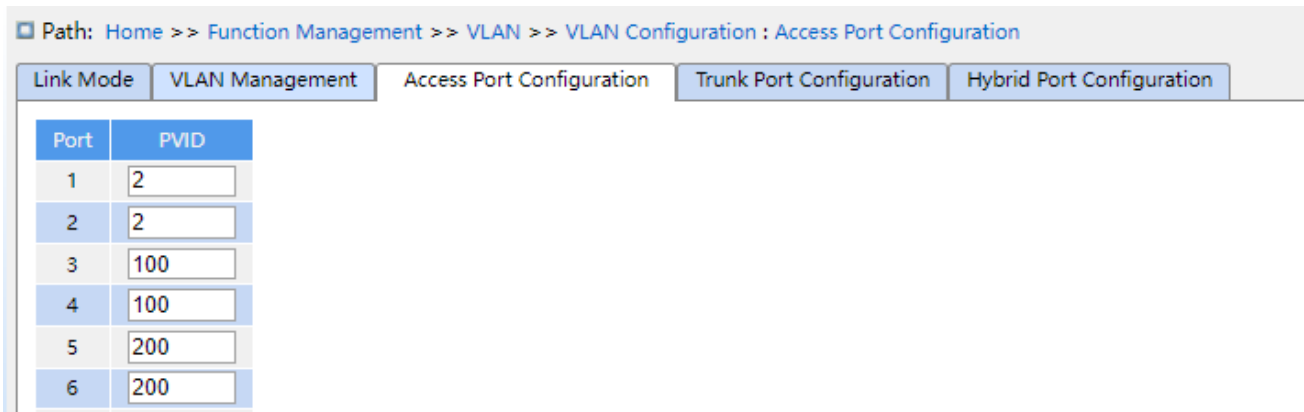

Figure 97 Configure Access Port

**PVID**

Configuration range: 1-4094

Default configuration: 1

Function: configure the default VLAN for the Access port.



**Caution:**

The VLAN need to be created before configuring VLAN ID of Access port, the Trunk, Hybrid port are similar.

4. Trunk Port Configuration, as shown below.

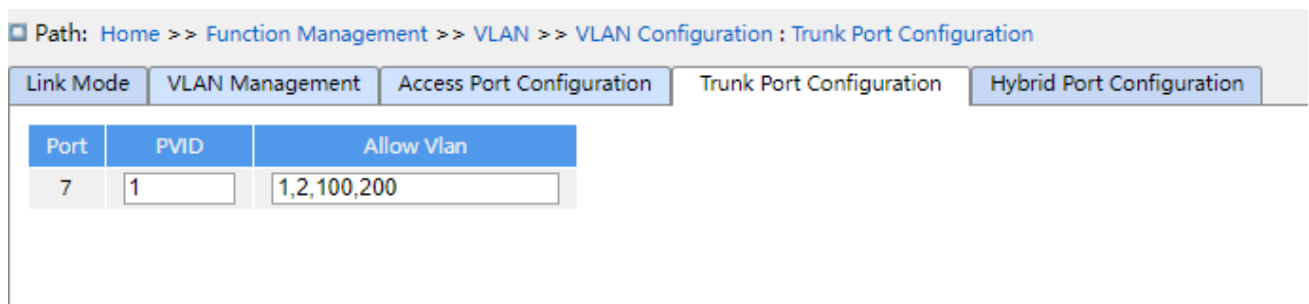

Figure 98 Trunk Port Configuration

**PVID**

Configuration range: 1-4094

Default configuration: 1

Function: Configure default VLAN of Trunk port.

**Allowed VLAN**

Configuration range: 1-4094, separated by half-angle comma ',' and a hyphen '-' (M-N, M must be less than N) , for example: 2, 33, 34-77.

Default configuration: 1

Function: Configure allowed VLAN of Trunk port.

5. Hybrid Port Configuration, as shown below.

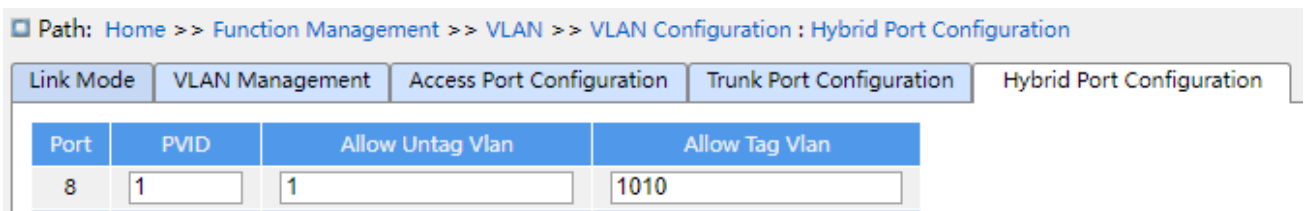

Figure 99 Hybrid Port Configuration

**PVID**

Configuration range: 1-4094

Default configuration: 1

Function: Configure default VLAN of Hybrid port.

**Allowed Untag VLAN**

Configuration range: 1-4094, separated by half-angle comma ',' and a hyphen '-' (M-N, M must be less than N) , for example: 2,33,34-77.

Default configuration: 1

Function: Configure allowed Untag VLAN of Hybrid port.

**Allowed Tag VLAN**

Configuration range: 1-4094, separated by half-angle comma ',' and a hyphen '-' (M-N, M must be less than N) , for example: 2,33,34-77.

Default configuration: None

Function: Configure allowed Tag VLAN of Hybrid port.

### 7.2.1.5 Typical Configuration Example

As shown in Figure 100, the entire LAN is divided into 3 VLANs: VLAN2, VLAN100, and VLAN200. It is required that the devices in the same VLAN can communicate with each other, but different VLANs are isolated. The terminal PCs cannot distinguish tagged packets, so the ports connecting Switch A and Switch B with PCs are set to access port. VLAN2, VLAN100, and VLAN200 packets need to be transmitted between Switch A and Switch B, so the ports connecting Switch A and Switch B should be set to trunk port, permitting the packets of VLAN 2, VLAN 100, and VLAN 200 to pass through. Table 4 shows specific configuration.

Table 4 VLAN Configuration

VLAN	Configuration
VLAN2	Set port 1 and port 2 of Switch A and B to access ports, and port 7 to trunk port.
VLAN100	Set port 3 and port 4 of Switch A and B to access ports, and port 7 to trunk port.
VLAN200	Set port 5 and port 6 of Switch A and B to access ports, and port 7 to trunk port.

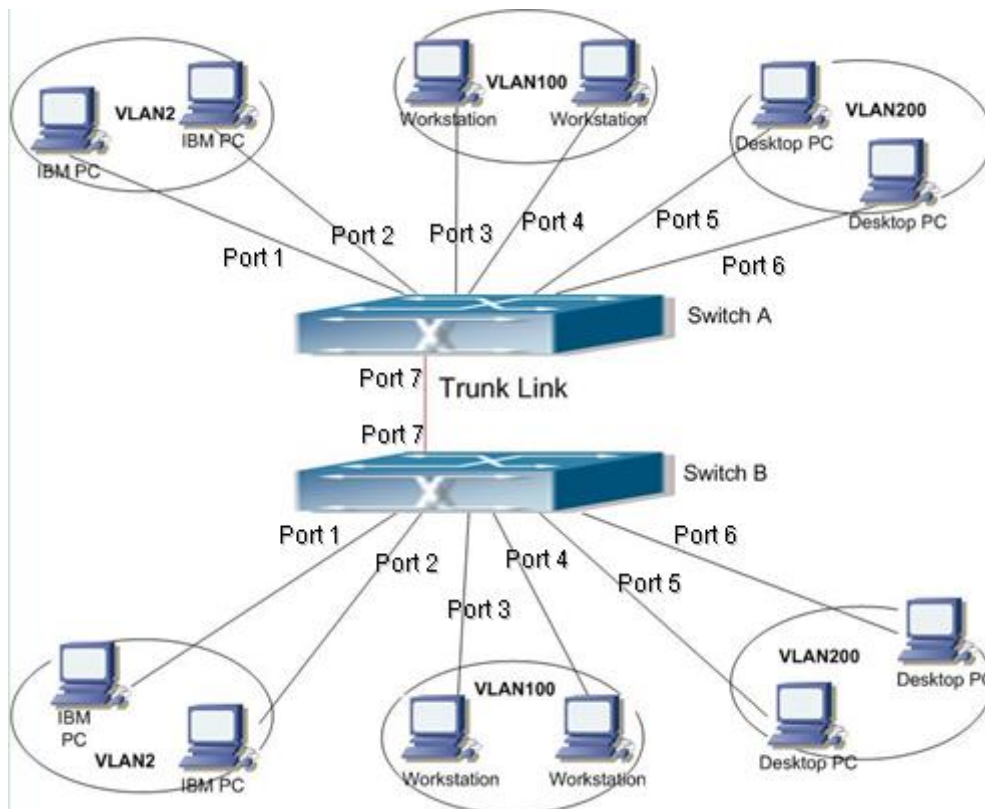

Figure 100 VLAN Application

### Configurations on Switch A and Switch B:

1. Configure allowed access VLANs to 1,2,100,200, as shown in Figure 97.
2. Configure ports 1, 2 as access ports, port VLAN as 2. Configure ports 3, 4 as access ports, port VLAN as 100. Configure ports 5, 6 as access ports, port VLAN as 200. Configure port 7 as trunk port, port VLAN as 1, allowed VLANs as 1,2,100,200, as shown in Figure 98.
3. Keep all the other parameters default.

## 7.2.2 GVRP

### 7.2.2.1 GARP Introduction

The Generic Attribute Registration Protocol (GARP) is used for spreading, registering, and cancelling certain information (VLAN, multicast address) among switches on the same network.

With GARP, the configuration information of a GARP member will spread the information to the entire switching network. A GARP member instructs the other GARP members to register or cancel its own configuration information by means of join/leave message respectively. The member also registers or cancels the configuration information of other members based on join/leave messages sent by other members.

GARP involves three types of messages: Join, Leave, and LeaveAll.

When a GARP application entity wants to register its own information on other switches, the entity sends a Join message. Join messages fall into two types: JoinEmpty and JoinIn. A JoinIn message is sent to declare a registered attribute, while a JoinEmpty message is sent to declare an attribute that is not registered yet.

When a GARP application entity wants to cancel its own information on other switches, the entity sends a Leave message.

After a GARP entity starts, it starts the LeaveAll timer. When the timer expires, the entity sends a LeaveAll message.

**Note:**

An application entity indicates a GARP-enabled port.

---

GARP timers include Hold timer, Join timer, Leave timer, LeaveAll timer.

**Hold Timer:** when a GARP-enabled switch receives a registration message, it starts a Hold timer rather than sending out the Join message immediately. When the Hold timer times out, it will put all registration information received during this time in a same Join message and send it out, reducing the message quantity for network stability.

**Join Timer:** in order to guarantee that the Join message can be reliably transmitted to other switches, the GARP-enabled switch will wait for a time interval of a Join timer after sending the first Join message. If the switch does not receive a Join In message during this time, it will send out a Join message again, otherwise, it won't send the second message.

**Leave Timer:** when a GARP-enabled switch wishes other switches to cancel its attribute information, it sends out a Leave message. Other GARP-enabled switches that receive this message will enable a Leave timer. If they do not receive a Join message until the timer times out, they will cancel this attribute information.

**LeaveAll Timer:** When a switch enables GARP, it starts a LeaveAll timer at the same time. When the timer times out, the switch will send a LeaveAll message to other GARP-Enabled switches and let them re-register their all attribute information, and then restart the LeaveAll timer to begin a new cycle.

### 7.2.2.2 GVRP Introduction

GVRP (GARP VLAN Registration Protocol) is a GARP application and is based on the GARP working mechanism to maintain the VLAN dynamic registration information of the device and propagate the information to other devices.

The GVRP-enabled device can receive VLAN registration information from other devices and dynamically update the local VLAN registration information, and the device can propagate the local VLAN registration information to other devices, reaching the consistency of VLAN information in all devices in the same LAN. The VLAN registration information propagated by GVRP contains not only the manually configured local static registration information, but also the dynamic registration information from other devices.



**Caution:**

GVRP port and port channel are mutually exclusive. The port in a port channel cannot be

---

configured as a GVRP port; the GVRP port cannot be added to a port channel.

### 7.2.2.3 Web Configuration

1. Global enable GVRP protocol, and configure timer, as shown below.

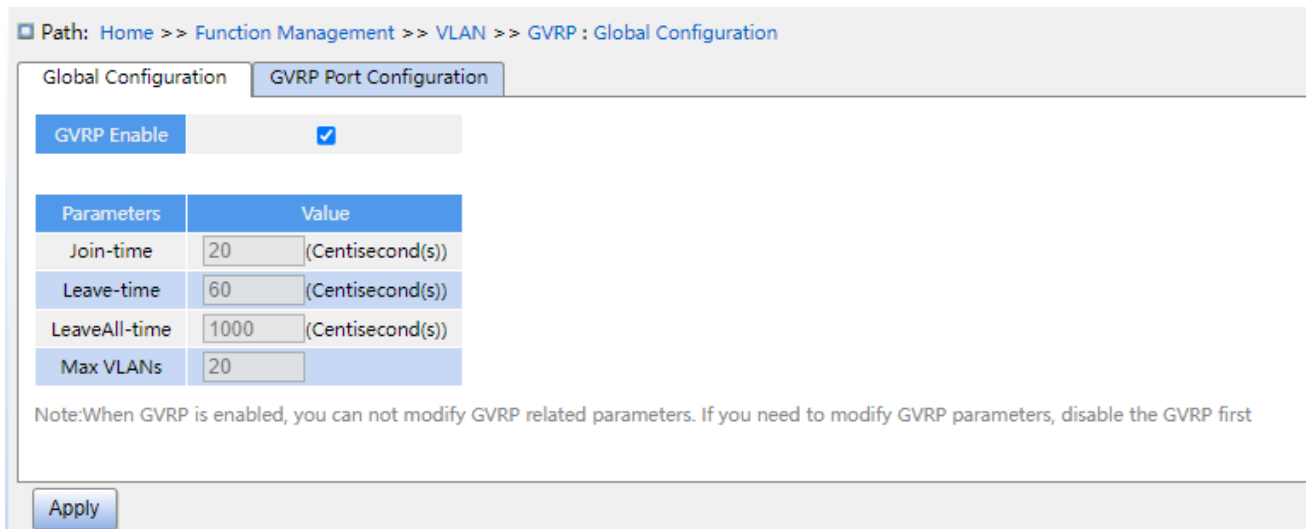

Figure 101 GVRP Global Configuration

#### GVRP enable

Configuration options: Enable/disable

Default configuration: Disable

Function: Enable or disable GVRP.

#### Join timer

Configuration options: 1-20 (centi-second)

Default configuration: 20 (centi-second)

Function: Configure Join timer value.

#### Leave timer

Configuration options: 60-300 (centi-second)

Default configuration: 60 (centi-second)

Function: Configure Leave timer value.

#### LeaveAll timer

Configuration options: 1000-5000 (centi-second)

Default configuration: 1000 (centi-second)

Function: Configure leave all timer value.



Description: if the LeaveAll timer for different devices times out at the same time, multiple LeaveAll messages are sent simultaneously to increase the number of unnecessary messages, in order to avoid the LeaveAll timer timeout on different devices at the same time, The value of the actual Leave all timer is a random value which is greater than the leave all timer value, less than 1.5 times the leave all timer value.

**Max VLANs**

Configuration range: 1~4094

Default configuration: 20

Function: Configure the registered dynamically max VLANs of GVRP port.



**Caution:**

Disable GVRP before configuring GVRP timer and Max VLANs.

2. GVRP Port Configuration, as shown below.

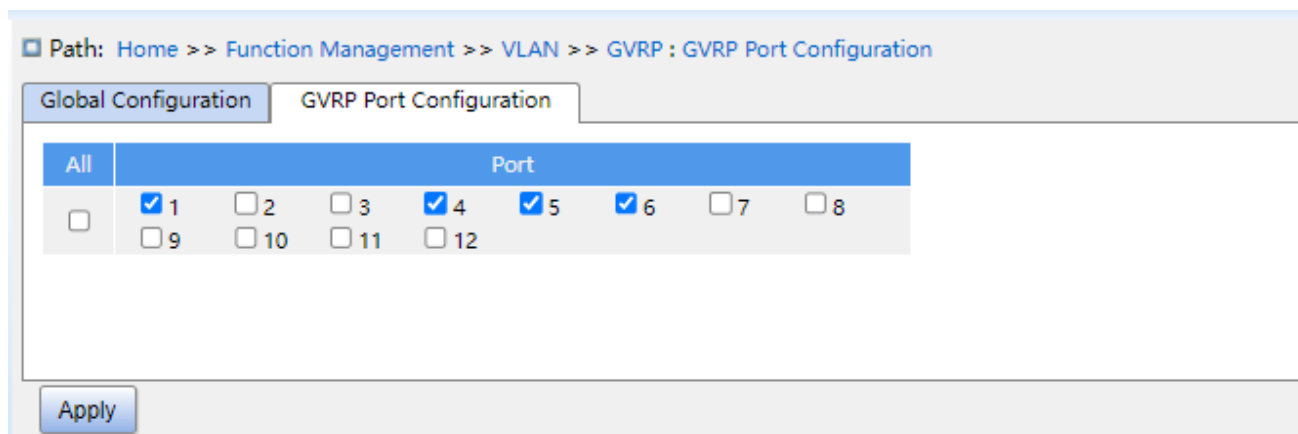

Figure 102 GVRP Port Configuration

**Port**

Configuration options: Enable/disable

Default configuration: Disable

Function: enable or disable GVRP of port.



**Caution:**

- The GVRP port should be configured as a trunk port;
- The GVRP port diffuses the VLAN property of other GVRP ports with the UP status.

### 7.2.2.4 Typical Configuration Example

As Figure 103 shows, GVRP needs to be enabled on devices so that VLAN information is dynamically registered and updated between device A and device B.

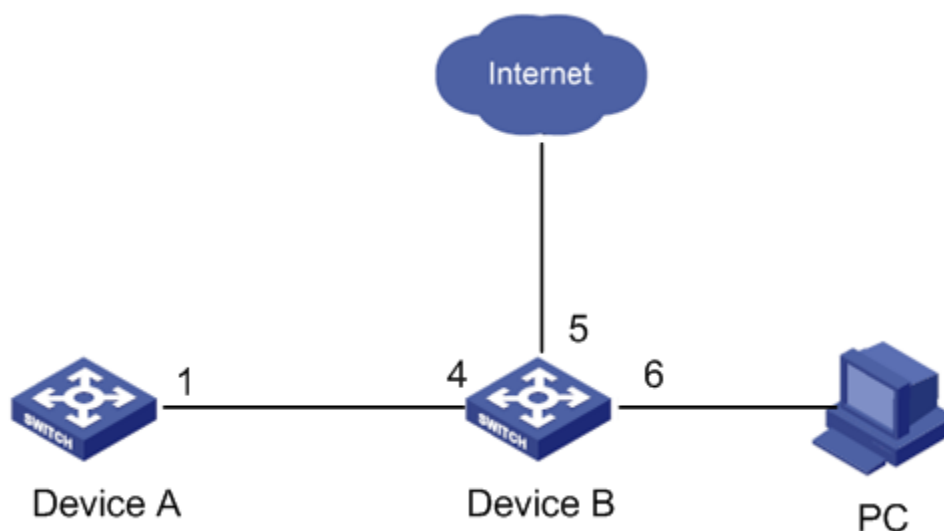

Figure 103 GVRP Configuration Example

Device A configuration are as follows:

1. Configure port 1 to trunk port, allowed VLANs to 1.
2. Enable global GVRP, as shown in Figure 101.
3. Enable GVRP on port 1, as shown in Figure 102.

Device B configuration are as follows:

1. Configure port 4 to trunk port, allowed VLANs to 1; configure port 5 to access port, allowed VLANs to 5; configure port 6 to trunk port, allowed VLANs to 1, 6.
2. Enable global GVRP, as shown in Figure 101.
3. Enable GVRP on port 4, 5, 6, as shown in Figure 102.

Port 1 of Switch A can register the same VLAN information as that of port 5 and 6 of Switch B.

### 7.2.3 VLAN STATUS

Check the port VLAN status, as shown below.

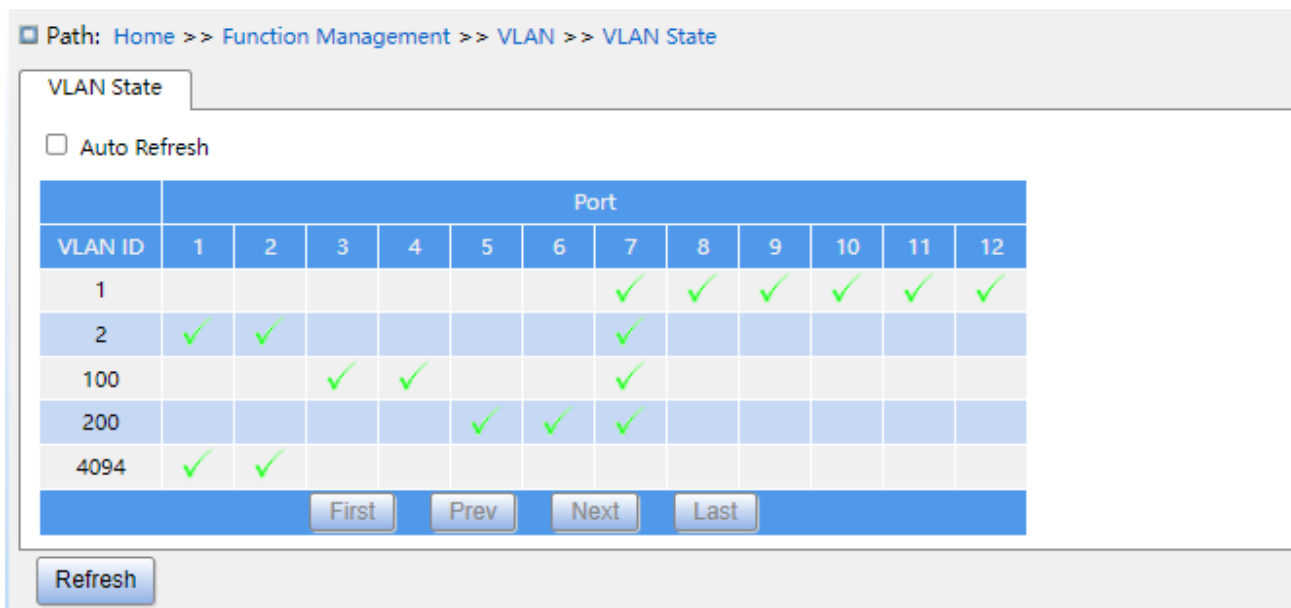

Figure 104 Port VLAN status

## 7.3 IP Configuration

### 7.3.1 IP Address Configuration

1. View the switch IP address through the Console port

Log in to the CLI of the switch through the console port. Run the command **show interface vlan 1** in the privileged user configuration mode to view the IP address of the switch.

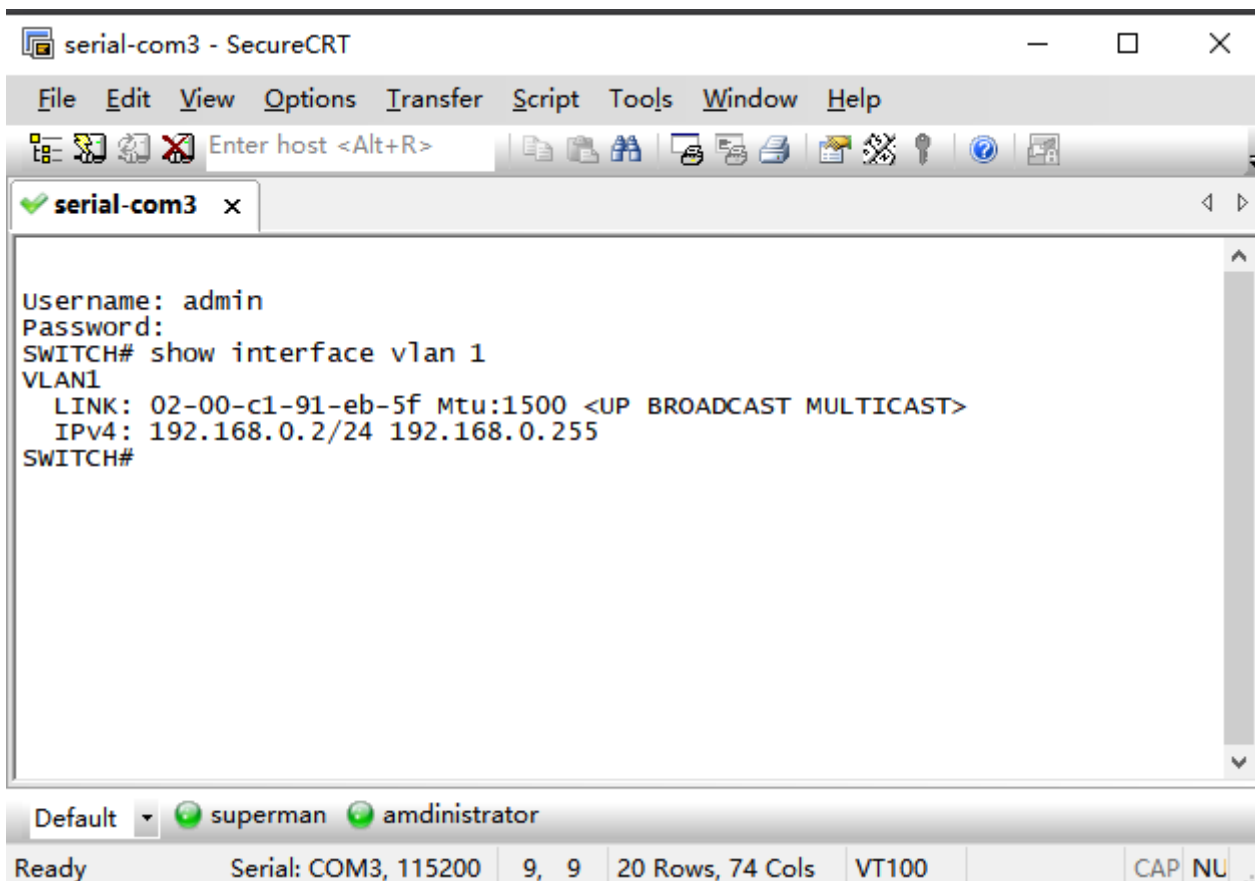

Figure 105 Displaying IP Address

## 2. Create IP interface

Hosts in different VLANs cannot communicate with each other. Their communication packets need to be forwarded by a router or Layer 3 switch through an IP interface.

This series switches support IP interfaces, which are virtual Layer 3 interfaces used for inter-VLAN communication. You can create one IP interface for each VLAN. The interface is used for forwarding Layer 3 packets of the ports in the VLAN.

## 3. Configure primary IP address

The primary IP address of the switch can be obtained by manual configuration and automatic, as shown below.

Path: Home >> Function Management >> IP Configuration : VLAN Interface Configuration

VLAN Interface Configuration    Secondary IP

<input type="checkbox"/> All	VLAN ID	Address
	<input type="text" value=""/>	--
<input type="checkbox"/>	1	<a href="#">192.168.0.6/24</a>
<input type="checkbox"/>	2	<a href="#">30.30.12.13/16</a>
<input type="checkbox"/>	3	<a href="#">100.1.12.12/16</a>
<input type="checkbox"/>	4010	--/--

Apply    Del

Figure 106 Vlan interface configuration

**VLAN ID**

Function: Configure VLAN property of IP interface, and only the VLAN member port can access the current IP interface.

**Address**

Function: IP address and mask obtained by the VLAN interface.

Path: Home >> Function Management >> IP Configuration : VLAN Interface Configuration -> IP Configuration [VLAN 1]

IP Configuration [VLAN 1]    Secondary IP

[<<Back](#)

Interface	VLAN 1
Method	Manual <input type="button" value="v"/>
Address	100.1.1.178
Mask Length	8
Client ID	<input type="button" value="v"/>
Hostname	<input type="text"/>
Fallback Address	<input type="text"/>
Fallback Mask Length	<input type="text"/>
Fallback Timeout	<input type="text"/>
MTU	1500

Figure 107 IP address configuration

**Method**

Configuration options: None/DHCP/Manual

Function: Manual, you need to manually configure the IP address and subnet mask. The switch automatically gets the IP address through DHCP protocol as DHCP client if enable DHCP, in this case, there should be DHCP server to assign IP address and subnet mask to client in the network.

**Address**

Configuration format: A.B.C.D

Function: IP address of the Vlan interface.

**Mask Length**

Function: a subnet mask is a 32-bit number, consisting of a sequence "1" and a sequence "0". "1" corresponds to the network number field and the subnet number field, while "0"

corresponds to the host number field. The mask length is the number of 1 in the mask.

### **Client ID**

Configuration options: Hex/ASCII/Port

Function: The detail filled information of carried option61 filed when specified IP send the DHCP requirement. Hex refers to filling option61 with type 01+mac address. ASCII refers to filling option61 with type 00+string. Port refers to filling option61 with the corresponding interface mac.

### **Hostname**

Configuration range: 1-63 characters

Function: Configure the host name of the VLAN interface.

### **Fallback Address**

Configuration format: A.B.C.D

Function: After the Vlan interface obtains the IP address timeout through the DHCP protocol, set the address to the fallback IP address.

### **Fallback Mask Length**

Function: a subnet mask is a 32-bit number, consisting of a sequence "1" and a sequence "0". "1" corresponds to the network number field and the subnet number field, while "0" corresponds to the host number field. The mask length is the number of 1 in the mask.

### **Fallback Timeout**

Configuration range: 0~4294967295s

Function: when the value is non-zero, the switch obtains the IP address attempt time through the DHCP protocol, need to configure the IP address manually at this time, after the attempt time out, the manually configured IP address takes effect. When the value is zero, the switch will try again and again until the IP address is obtained through the DHCP protocol, no need to manually configure the IP address.

### **MTU**

Configuration range: 68~9600

Default configuration: 1500

Function: Configure the maximum packet length that can pass on the IP layer.

## 4. Secondary IP Configuration

Manually configure the secondary IP address of the switch's IP interface, as shown below.

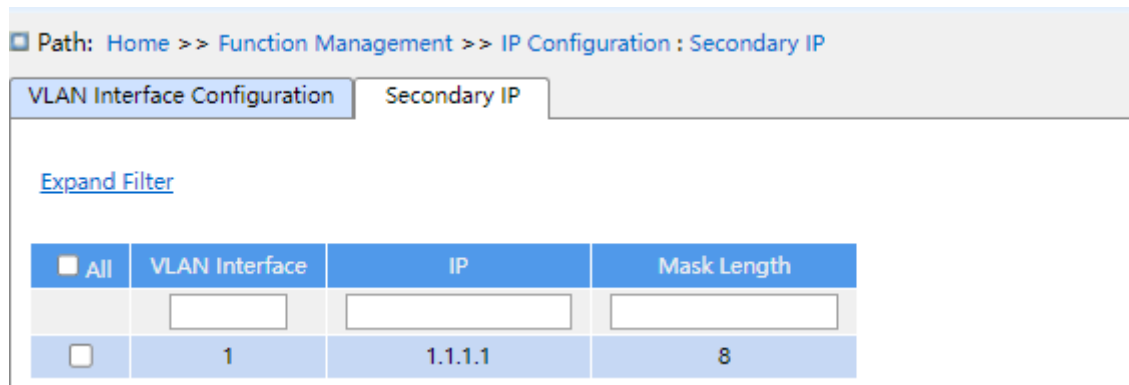

Figure 108 Secondary IP Configuration

### VLAN Interface

Function: configure the VLAN property of the IP interface, and only this VLAN member port can access the current IP interface.

### IP

Configure format: A.B.C.D

Function: manually configure IP address.

### Mask Length

Function: a subnet mask is a 32-bit number, consisting of a sequence "1" and a sequence "0". "1" corresponds to the network number field and the subnet number field, while "0" corresponds to the host number field. The mask length is the number of 1 in the mask.



**Caution:**

- Each IP interface corresponds to a primary IP address and may correspond to multi-secondary IP addresses;
- Different IP interfaces should be configured with primary and secondary IP addresses for different network segments.



## 7.4 Port Aggregation

### 7.4.1 Static Aggregation

#### 7.4.1.1 Introduction

Port channel is to bind a group of physical ports that have the same configuration to a logical port to increase bandwidth and improve transmission speed. The member ports in a same group share traffic and serve as dynamic backups for each other, improving connection reliability.

Port group is a physical port group on the configuration layer. Only the physical ports that join in port group can participate in link aggregation and become a member of port channel. When physical ports in a port group meet certain conditions, they can conduct port aggregation and form a port channel and become an independent logical port, thereby increasing network bandwidth and providing link backup.

#### 7.4.1.2 Implementation

As shown in Figure 109, three ports on Switch A and Switch B aggregate to form a port channel. The bandwidth of the port channel is the total bandwidth of these three ports.

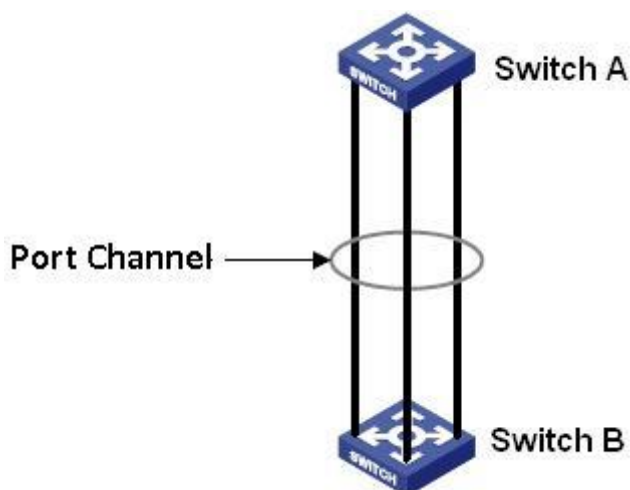

Figure 109 Port Channel

If Switch A sends packets to Switch B by way of the port channel, Switch A determines the member port for transmitting the traffic based on the calculation result of load sharing. When

one member port of the port channel fails, the traffic transmitted through the port is taken over by another normal port based on load sharing algorithm.



**Caution:**

- A port can be added to only one port group.
- Only full duplex ports can join an aggregation.
- The port in a port channel cannot be enabled LACP, and a port enabled LACP cannot be added to a port channel.
- Port channel and redundant port are mutually exclusive. The port in a port channel cannot be configured as a redundant port, and a redundant port cannot be added to a port channel.
- Redundant port in this document refers to DRP ring port, DRP backup port, RSTP port, and MSTP port.

### 7.4.1.3 Web Configuration

1. Static aggregation configuration, as shown below.

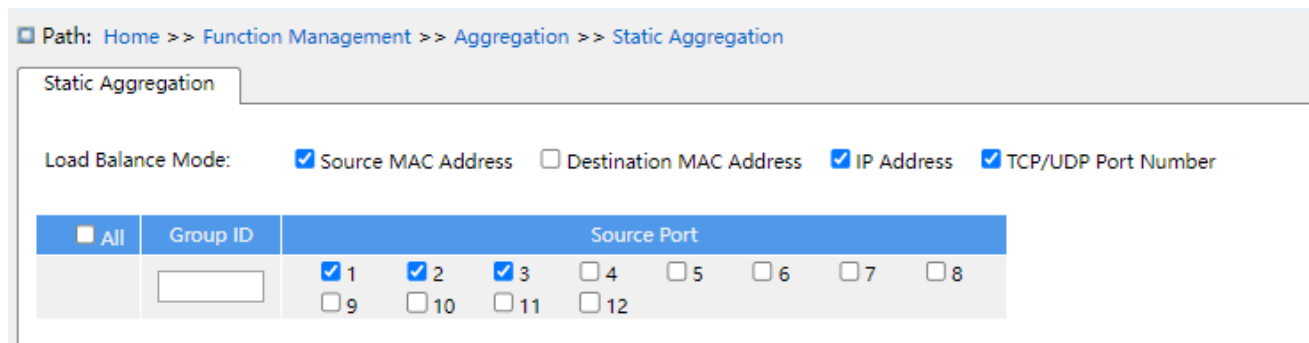

Figure 110 Static Aggregation Configuration

#### Load Balance Mode

Configuration options: Source MAC address/ destination MAC/IP address/ TCP/UDP port number

Default configuration: Source MAC address/IP address/ TCP/UDP port number

Function: configure load balance mode of aggregation group.

Description: the source mac address balances the traffic according to the source mac address; the destination mac address balances the traffic according to the destination mac address; the IP address balances the traffic according to the IP address; the port number of TCP / UDP balances the traffic according to the TCP/UDP port number.

## Group ID

Configuration range: 1-10

Function: Configure group ID.

Description: the member ports of the same aggregation group have the same port properties. The number of aggregation groups depends on the device port, and each aggregation group supports up to 8 member ports.

## Source Port

Configuration options: Enable/disable

Function: Select the port to join the specified aggregation group.

### 7.4.1.4 Typical Configuration Example

As shown in Figure 109, add three ports (port 1, 2, and 3) of Switch A to port group 1 and three ports (port 1, 2, and 3) of switch B to port group 1. Use network cables to connect these ports to form a port channel, realizing load sharing among ports. (It is assumed that the three ports on Switch A and B have the same attributes respectively).

#### Configuration on switches:

1. Add port 1, 2, and 3 of switch A to port group 1, as shown in Figure 110.
2. Add port 1, 2, and 3 of switch B to port group 1, as shown in Figure 110.

## 7.4.2 LACP

### 7.4.2.1 Introduction

Link Aggregation Control Protocol (LACP) is based on the IEEE802.3ad standard. It is used to exchange information with the peer port over Link Aggregation Control Protocol Data Unit (LACPDU), in order to select a member port in the dynamic aggregation group.

### 7.4.2.2 Implementation

A port enabled with LACP informs the peer port of its LACP priority of the local equipment, equipment MAC address, LACP priority of the port, port number and key value by sending an LACPDU message. The peer port negotiates with the local port after receiving the LACPDU message:

1. Compare the IDs of the equipment at both ends (equipment ID = equipment LACP priority+ equipment MAC address). At first, compare the LACP priorities. If the LACP priorities are the same, compare their MAC addresses. Select the equipment with a smaller ID as the master equipment.
2. Compare the port IDs of the master equipment (port ID = LACP priority of the port + port number). At first, compare the LACP priorities of the ports. If the port LACP priorities are the same, compare the port numbers. Select the port with a smaller ID as the reference port.
3. If this port and reference port have the same key values, and the same port attribute configurations in Up state, and the peer ports of this port and the reference port have the same key values and port attribute configurations, this port can become a member port of the dynamic aggregation group.

### 7.4.2.3 Web Configuration

1. Configure LACP priority, as shown below.

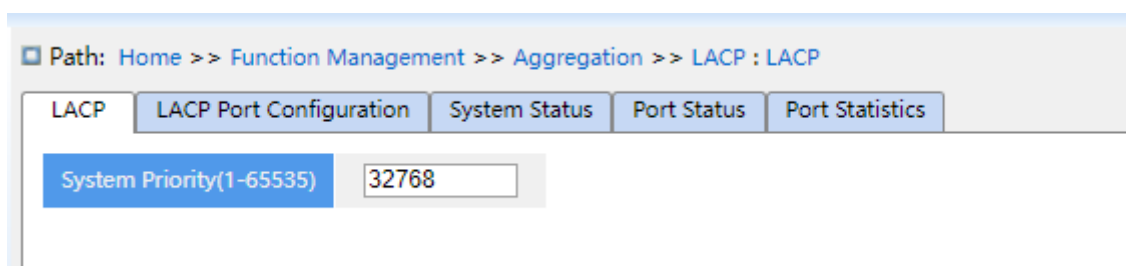

Figure 111 Configure LACP Priority

### LACP

Configuration range: 1-65535

Default configuration: 32768

Function: Configure LACP priority, used to select the main device when LACP negotiation.

2. LACP Port Configuration, as shown below.

Path: Home >> Function Management >> Aggregation >> LACP : LACP Port Configuration

LACP LACP Port Configuration System Status Port Status Port Statistics

Port	LACP Enable	Key	Role	Timeout	Priority
*	<input type="checkbox"/>	<input type="radio"/> Auto <input type="radio"/> Specific	<input type="radio"/> Active <input type="radio"/> Passive	<input type="radio"/> Fast <input type="radio"/> Slow	
1	<input type="checkbox"/>	<input checked="" type="radio"/> Auto <input type="radio"/> Specific	<input checked="" type="radio"/> Active <input type="radio"/> Passive	<input checked="" type="radio"/> Fast <input type="radio"/> Slow	32768
2	<input type="checkbox"/>	<input checked="" type="radio"/> Auto <input type="radio"/> Specific	<input checked="" type="radio"/> Active <input type="radio"/> Passive	<input checked="" type="radio"/> Fast <input type="radio"/> Slow	32768
3	<input type="checkbox"/>	<input checked="" type="radio"/> Auto <input type="radio"/> Specific	<input checked="" type="radio"/> Active <input type="radio"/> Passive	<input checked="" type="radio"/> Fast <input type="radio"/> Slow	32768
4	<input type="checkbox"/>	<input checked="" type="radio"/> Auto <input type="radio"/> Specific	<input checked="" type="radio"/> Active <input type="radio"/> Passive	<input checked="" type="radio"/> Fast <input type="radio"/> Slow	32768
5	<input type="checkbox"/>	<input checked="" type="radio"/> Auto <input type="radio"/> Specific	<input checked="" type="radio"/> Active <input type="radio"/> Passive	<input checked="" type="radio"/> Fast <input type="radio"/> Slow	32768
6	<input type="checkbox"/>	<input checked="" type="radio"/> Auto <input type="radio"/> Specific	<input checked="" type="radio"/> Active <input type="radio"/> Passive	<input checked="" type="radio"/> Fast <input type="radio"/> Slow	32768
7	<input type="checkbox"/>	<input checked="" type="radio"/> Auto <input type="radio"/> Specific	<input checked="" type="radio"/> Active <input type="radio"/> Passive	<input checked="" type="radio"/> Fast <input type="radio"/> Slow	32768
8	<input type="checkbox"/>	<input checked="" type="radio"/> Auto <input type="radio"/> Specific	<input checked="" type="radio"/> Active <input type="radio"/> Passive	<input checked="" type="radio"/> Fast <input type="radio"/> Slow	32768
9	<input type="checkbox"/>	<input checked="" type="radio"/> Auto <input type="radio"/> Specific	<input checked="" type="radio"/> Active <input type="radio"/> Passive	<input checked="" type="radio"/> Fast <input type="radio"/> Slow	32768
10	<input type="checkbox"/>	<input checked="" type="radio"/> Auto <input type="radio"/> Specific	<input checked="" type="radio"/> Active <input type="radio"/> Passive	<input checked="" type="radio"/> Fast <input type="radio"/> Slow	32768
11	<input type="checkbox"/>	<input checked="" type="radio"/> Auto <input type="radio"/> Specific	<input checked="" type="radio"/> Active <input type="radio"/> Passive	<input checked="" type="radio"/> Fast <input type="radio"/> Slow	32768
12	<input type="checkbox"/>	<input checked="" type="radio"/> Auto <input type="radio"/> Specific	<input checked="" type="radio"/> Active <input type="radio"/> Passive	<input checked="" type="radio"/> Fast <input type="radio"/> Slow	32768

Apply

Figure 112 LACP port configuration

**LACP Enable**

Configuration options: Enable/disable

Default configuration: Disable

Function: whether enable LACP of port.

**Key**

Configuration options: Auto/specific (1~65535)

Default configuration: Auto

Function: Configure port key value. Key value is determined by port rate if selecting Auto, key=1 (10Mb); key=2 (100Mb); key=3 (1000Mb), ports with different key values cannot be added to dynamic aggregation groups.

**Role**

Configuration options: Active/ passtive

Default configuration: Active

Function: select the role of the LACP. The active port will send the LACPDU message to the end port actively; the passive port receives the LACPDU message to the opposite end and

sends the LACPDU message to the end port.



**Caution:**

At least one of the two ports connected is active, otherwise the two ends will not be able to exchange information.

**Timeout**

Configuration options: Fast/slow

Default configuration: Fast

Function: Configure the active port to send LACPDU message time interval. The fast refers to time interval is 1s and the slow refers to time interval is 30s.

**Priority**

Configuration range: 1~65535

Default configuration: 32768

Function: Configure port LACP priority, use to select reference ports. Ports with low priority in the main device are selected as reference ports.

3. View LACP system status, as shown below.

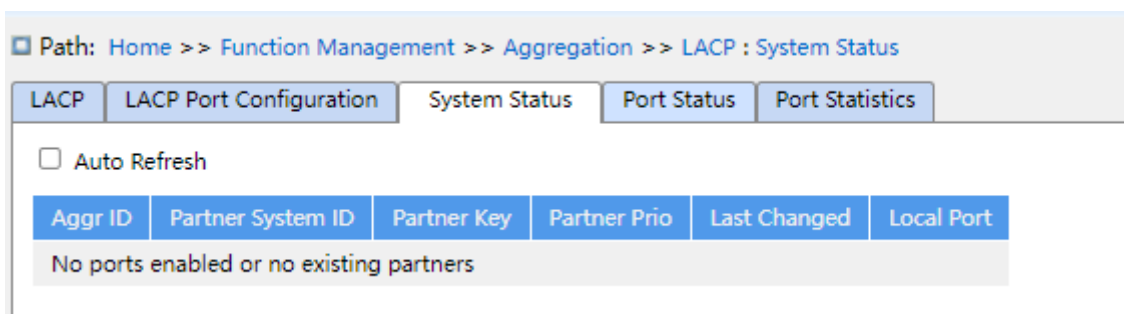

Figure 113 View LACP System Status

**Aggr ID**

Function: Used to indicate the ID of an aggregation group.

**Partner System ID**

Function: Use the MAC address, which indicates the device ID of the opposite end.

**Partner Key**

Function: Display the port key value of the peer device.

**Partner Prio**

Function: Indicates the system priority at the opposite end.

**Last Changed**

Function: Indicates that the LACP has been switched once before the current display interval.

**Local port**

Function: Enables the local port number of LACP.

4. View LACP port status, as shown below.

Path: Home >> Function Management >> Aggregation >> LACP : Port Status

Auto Refresh

Port	LACP	Key	Aggr ID	Partner System ID	Partner Port	Partner Prio
1	No	0	--	--	--	--
2	No	0	--	--	--	--
3	No	0	--	--	--	--
4	No	0	--	--	--	--
5	No	0	--	--	--	--
6	No	0	--	--	--	--
7	No	0	--	--	--	--
8	No	0	--	--	--	--
9	No	0	--	--	--	--
10	No	0	--	--	--	--
11	No	0	--	--	--	--
12	No	0	--	--	--	--

Figure 114 View LACP port status

**LACP Status**

Displaying options: Yes/No

Function: Display LACP status of port. “Yes” refers to LACP is enable and port is up status. “No” refers to LACP is disable and port is down status.

**Key**

Function: Display the local device port key value.

**Partner Prio**

Function: Display the peer port priority.

5. View LACP port statistics, as shown below.

Path: Home >> Function Management >> Aggregation >> LACP : Port Statistics

LACP | LACP Port Configuration | System Status | Port Status | Port Statistics

Auto Refresh

Port	LACP Received	LACP Transmitted	Discarded	
			Unknown	Illegal
1	0	0	0	0
2	0	0	0	0
3	0	0	0	0
4	0	0	0	0
5	0	0	0	0
6	0	0	0	0
7	0	0	0	0
8	0	0	0	0
9	0	0	0	0
10	0	0	0	0
11	0	0	0	0
12	0	0	0	0

Figure 115 View LACP Port Statistics

**Port**

Configuration scope: all ports of the switch yes.

**LACP Received**

Function: The number of LACP messages received by this port.

**LACP Transmitted**

Function: The number of ACP messages sent by this port.

**Discarded**

Function: Unknown, discard the number of unknown LACP messages. Illegal, discard the number of illegal LACP messages.

**7.4.2.4 Typical Configuration Example**

As shown in Figure 109, add three ports (port 1, 2, and 3) of Switch A to port group 1 and three ports (port 1, 2, and 3) of switch B to port group 1. Use network cables to connect these ports to form a port channel, realizing load sharing among ports. (It is assumed that the three ports on Switch A and B have the same attributes respectively).



**Configuration on switches:**

1. Enable LACP on port 1, 2, and 3 of switch A , as shown in Figure 112.
2. Enable LACP on port 1, 2, and 3 of switch B , as shown in Figure 112.

## 7.5 Redundancy

### 7.5.1 DT-Ring

#### 7.5.1.1 Introduction

DT-Ring and DT-Ring+ are Kyland-proprietary redundancy protocols. They enable a network to recover within 50ms when a link fails, ensuring stable and reliable communication.

DT rings fall into two types: port-based (DT-Ring-Port) and VLAN-based (DT-Ring-VLAN).

DT-Ring-Port: specifies a port to forward or block packets.

DT-Ring-VLAN: specifies a port to forward or block the packets of a specific VLAN. This allows multiple VLANs on a tangent port, that is, one port is part of different redundant rings based on different VLANs.

DT-Ring-Port and DT-Ring-VLAN cannot be used together.

#### 7.5.1.2 Concepts

Master: One ring has only one master. The master sends DT-Ring protocol packets and detects the status of the ring. When the ring is closed, the two ring ports on the master are in forwarding and blocking state respectively.

**Note:**

The first port whose link status changes to up when the ring is closed is in forwarding state.

The other ring port is in blocking state.

---

Slave: A ring can include multiple slaves. Slaves listen to and forward DT-Ring protocol packets and report fault information to the master.

Backup port: The port for communication between DT rings is called the backup port.

Master backup port: When a ring has multiple backup ports, the backup port with the larger MAC address is the master backup port. It is in forwarding state.

Slave backup port: When a ring has multiple backup ports, all the backup ports except the master backup port are slave backup ports. They are in blocking state.

Forwarding state: If a port is in forwarding state, the port can both receive and send data.

Blocking state: If a port is in blocking state, the port can receive and forward only DT-Ring protocol packets, but not other packets.

### 7.5.1.3 Implementation

#### DT-Ring-Port Implementation

The forwarding port on the master periodically sends DT-Ring protocol packets to detect ring status. If the blocking port of the master receives the packets, the ring is closed; otherwise, the ring is open.

Working process of switch A, Switch B, Switch C, and Switch D:

1. Configure Switch A as the master and the other switches as slaves.
2. Ring port 1 on the master is in forwarding state while ring port 2 is in blocking state. Both two ports on the slave are in forwarding state.
3. If link CD is faulty, as shown in as shown below.
  - a) When link CD is faulty, port 6 and port 7 on the slave are in blocking state. Port 2 on the master changes to forwarding state, ensuring normal link communication.
  - b) When the fault is rectified, port 6 and port 7 on the slave are in forwarding state. Port 2 on the master changes to blocking state. Link switchover occurs and links restore to the state before CD is faulty.

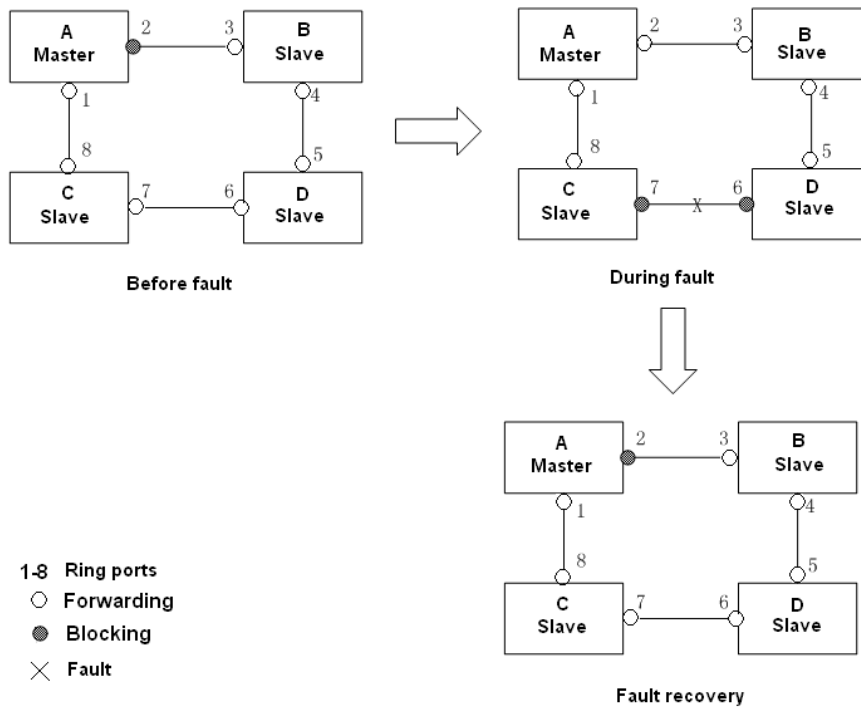

Figure 116 CD Link Fault

4. If link AC is faulty, as shown in as shown below.

a) When link AC is faulty, port 1 is in blocking state and port 2 changes to forwarding state, ensuring normal link communication.

b) After the fault is rectified, port 1 is still in blocking state and port 8 is in forwarding state.

No switchover occurs.

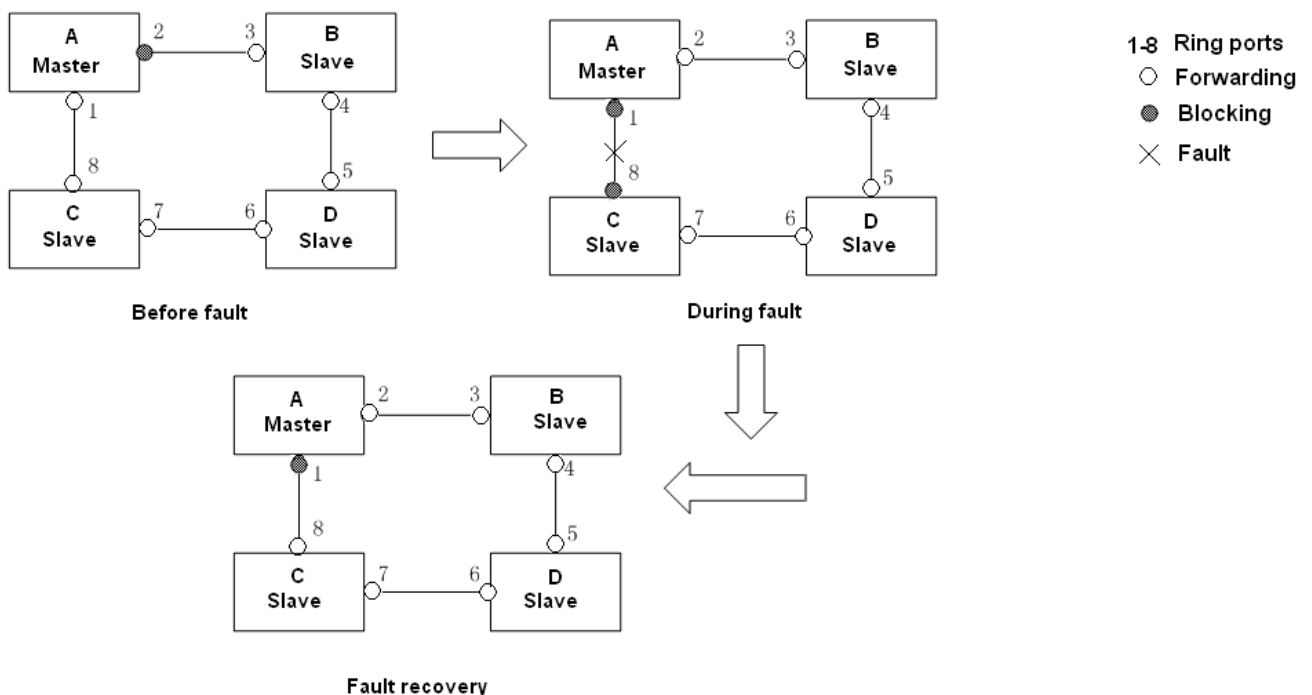

Figure 117 DT-Ring Link Fault



**Caution:**

Link status change affects the status of ring ports.

**DT-Ring-VLAN Implementation**

DT-Ring-VLAN allows the packets of different VLANs to be forwarded in different paths. Each forwarding path for a VLAN forms a DT-Ring-VLAN. Different DT-VLAN-Rings can have different masters. As shown in Figure 118, two DT-Ring-VLANs are configured.

Ring links of DT-Ring-VLAN 10: AB-BC-CD-DE-EA.

Ring links of DT-Ring-VLAN 20: FB-BC-CD-DE-EF.

The two rings are tangent at link BC, CD, and DE. Switch C and Switch D share the same ports in the two rings, but use different logical links based on VLANs.

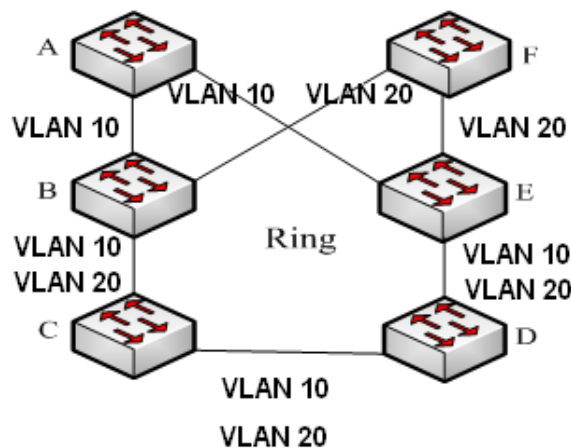

Figure 118 DT-Ring-VLAN



**Note:**

In each DT-Ring-VLAN logical ring, the implementation is identical with that of DT-Ring-Port.

**DT-Ring+ Implementation**

DT-Ring+ can provide backup for two DT rings, as shown in as shown below. One backup port is configured respectively on Switch C and Switch D. Which port is the master backup port depends on the MAC addresses of the two ports. If the master backup port or its link fails, the slave backup port will forward packets, preventing loops and ensuring normal

communication between redundant rings.

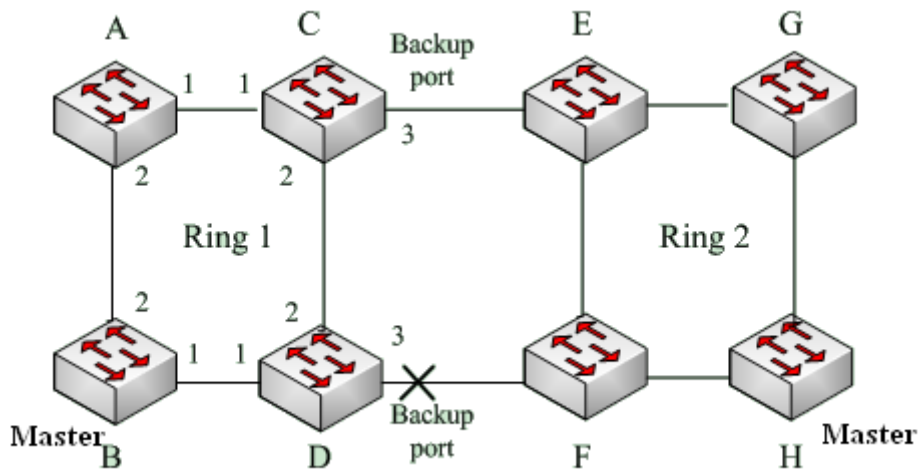

Figure 119 DT-Ring+ Topology



**Caution:**

Link status change affects the status of backup ports.

**7.5.1.4 Explanation**

DT-Ring configurations should meet the following conditions:

- All switches in the same ring must have the same domain number.
- Each ring can only have one master and multiple slaves.
- Only two ports can be configured on each switch for a ring.
- For two connected rings, backup ports can be configured only in one ring.
- A maximum of two backup ports can be configured in one ring.
- On a switch, only one backup port can be configured for one ring.
- DT-Ring-Port and DT-Ring-VLAN cannot be configured on one switch at the same time.

**7.5.1.5 Web Configuration**

1. Configure DT-Ring redundant ring mode, as shown in Figure 120.

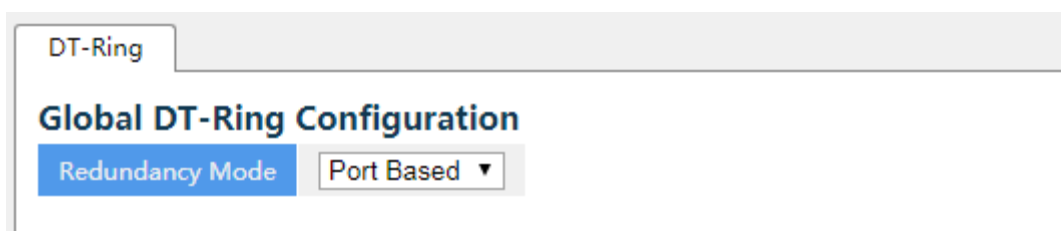

Figure 120 Redundant Ring Mode Configuration

**Redundancy Mode**

Options: Port Based/Vlan Based

Default: Port Based

Function: Choose DT-Ring redundant ring mode.



**Caution:**

- Port-based ring protocols include RSTP, DT-Ring-Port, and DRP-Port, and VLAN-based ring protocols include MSTP, DT-Ring-VLAN, and DRP-VLAN.
- VLAN-based ring protocols are mutually exclusive, and only type of VLAN-based ring protocol can be configured for one device.
- Port-based ring protocol and VLAN-based ring protocol are mutually exclusive, and only one ring protocol mode can be selected for one device.

2. Configure DT-Ring-Port and DT-Ring-VLAN, as shown in Figure 121 and Figure 122.

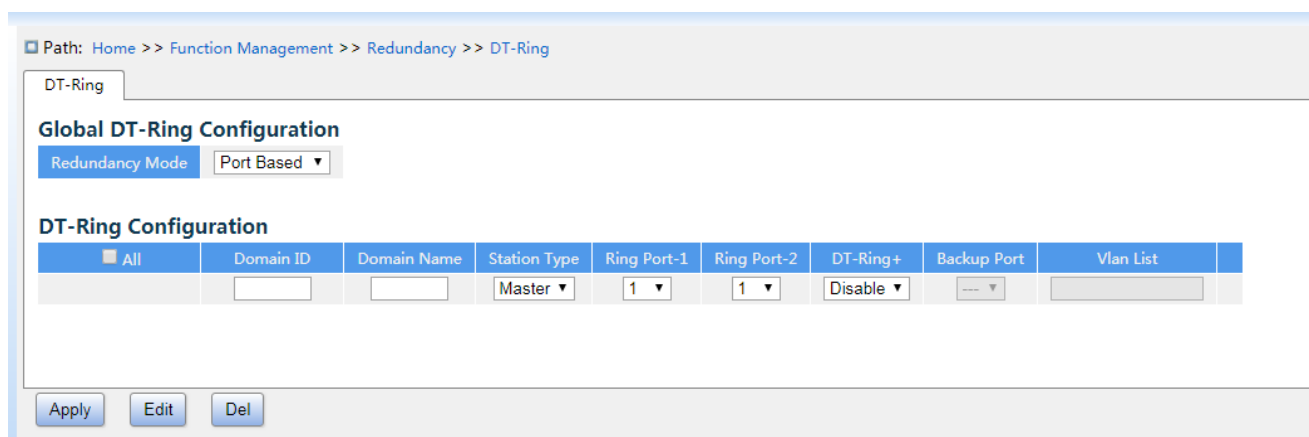

Figure 121 DT-Ring-Port Configuration



Figure 122 DT-Ring-VLAN Configuration

**Domain ID**

Range: 1~32

Function: The domain ID is used to distinguish different rings. One switch supports a maximum of 16 VLAN-based rings, the number of port-based rings depends on the number of switch ports.

**Domain Name**

Range: 1~31 characters

Function: Configure the domain name.

**Station Type**

Options: Master/Slave

Default: Master

Function: Select the switch role in a ring.

**Ring Port-1/Ring Port-2**

Options: all switch ports

Function: Select two ring ports.

**Caution:**

- DT-Ring ring port or backup port and port channel are mutually exclusive. A DT-Ring ring port or backup port cannot be added to a port channel; a port in a port channel cannot be configured as a DT-Ring ring port or backup port.
  - Ring ports between port-based ring protocols RSTP, DT-Ring-Port, and DRP-Port are mutually exclusive, that is, the ring port and backup port of DT-Ring-Port cannot be configured as RSTP port, DRP-Port ring port, or DRP-Port backup port; RSTP port, DRP-Port ring port, and DRP-Port backup port cannot be configured as DT-Ring-Port ring port or backup port.
  - It is not recommended that ports in the isolation group are configured as DT-Ring ports and backup ports at the same time, and DT-Ring ports and backup ports cannot be added to the isolation group.
- 

**DT-Ring+**

Options: Enable/Disable

Default: Disable

Function: Enable/disable DT-Ring+.

### Backup Port

Options: all switch ports

Function: Set a port to backup port.

Explanation: Enable DT-Ring+ before setting backup port.



**Caution:**

Do not configure a ring port as a backup port.

### VLAN List

Options: all created VLANs

Function: Select the VLANs for the ring port. When there are multiple VLANs, you can separate the VLANs by a comma (,) and an en dash (-), where an en dash is used to separate two consecutive VLAN IDs and a comma is used to separate two inconsecutive VLAN IDs.

3. View and modify DT-Ring configuration, as shown in Figure 123.

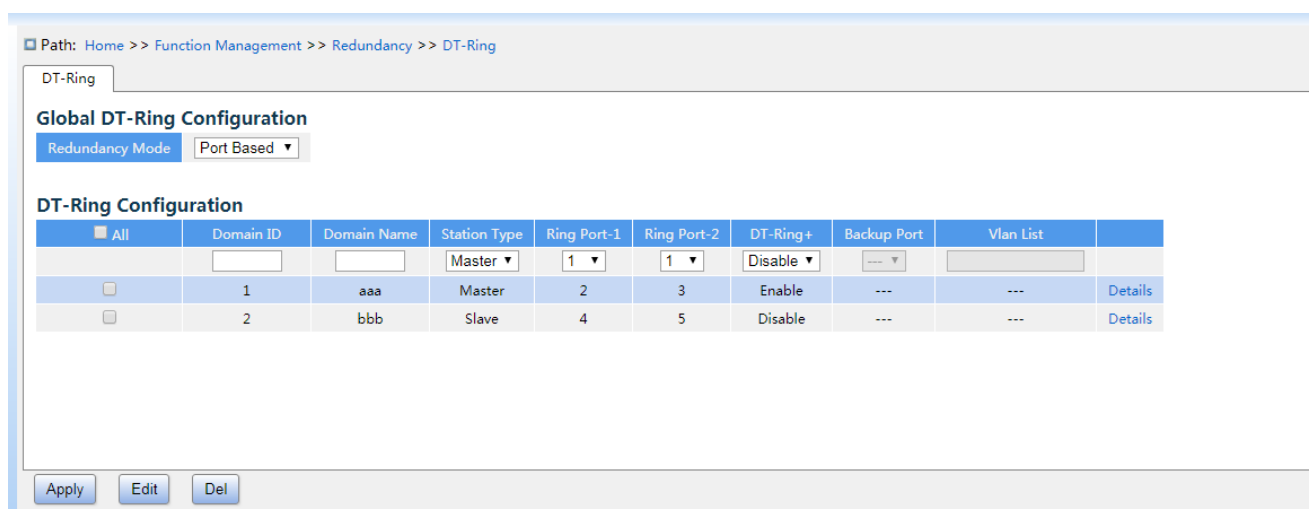

Figure 123 DT-Ring Configuration

Select a DT-Ring entry, click <Modify> to edit the DT-Ring entry configuration; click <Delete> to delete the designated DT-Ring entry.

4. Click a DT-Ring entry in Figure 123 to show DT-Ring and port status, as shown in Figure



124.

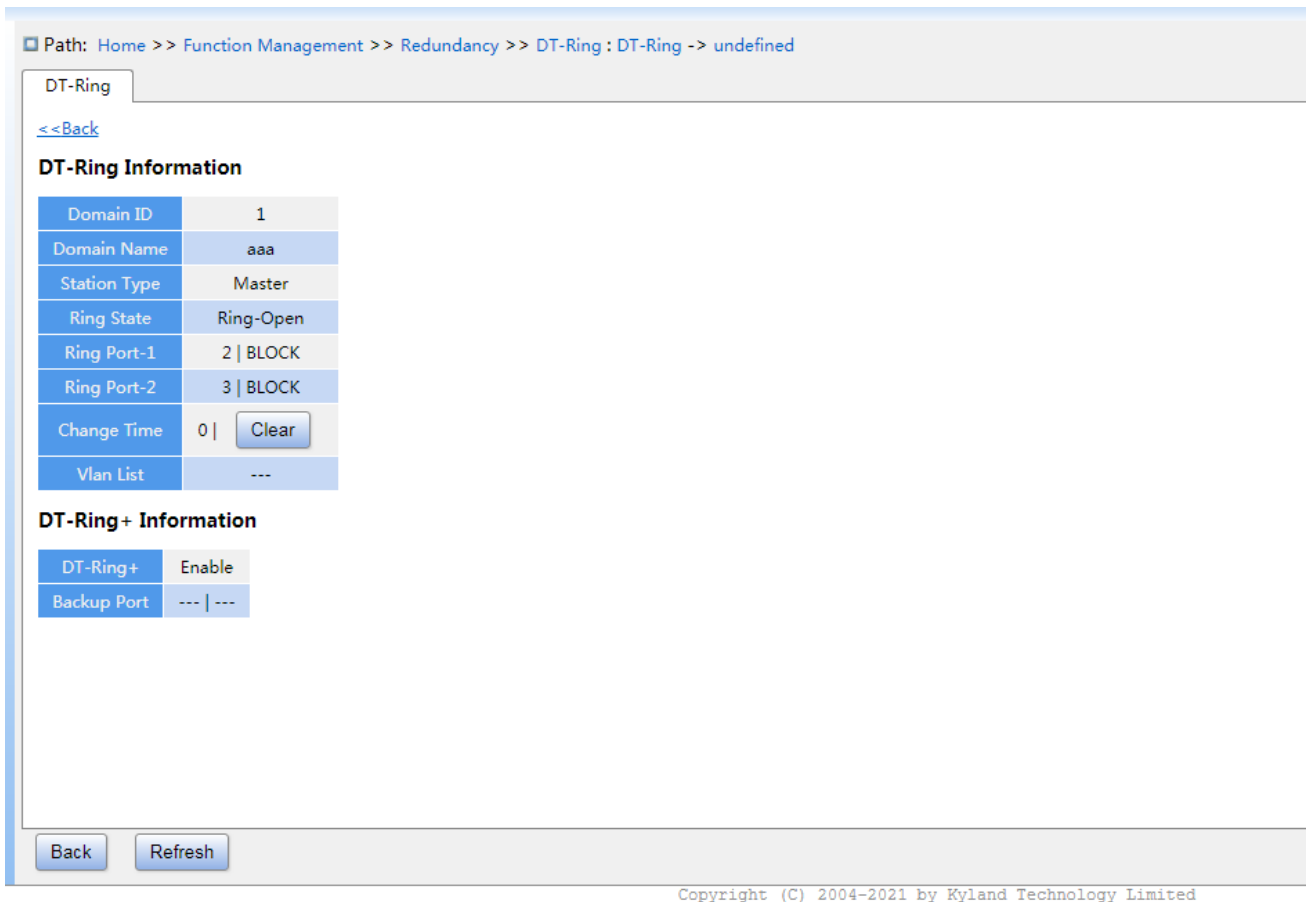

Figure 124 DT-Ring State

### 7.5.1.6 Typical Configuration Example

As shown in Figure 119, switch A, B, C, and D form Ring 1; Switch E, F, G, and H form ring 2. Links CE and DF are the backup links between Ring 1 and Ring 2.

#### Configuration on Switch A:

1. Configure domain ID to 1, domain name to a, ring port to 1, 2, station type to slave, DT-Ring+ to disable, do not set backup port, as shown in Figure 121.

#### Configuration on Switch B:

2. Configure domain ID to 1, domain name to a, ring port to 1, 2, station type to master, DT-Ring+ to disable, do not set backup port, as shown in Figure 121;

#### Configuration on Switch C and Switch D:

3. Configure domain ID to 1, domain name to a, ring port to 1, 2, station type to slave, DT-Ring+ to enable, backup port to 3, as shown in Figure 121;

**Configuration on Switch E, Switch F, and Switch G:**

4. Configure domain ID to 2, domain name to b, ring port to 1, 2, station type to slave, DT-Ring+ to disable, do not set backup port, as shown in Figure 121;

**Configuration on Switch H:**

5. Configure domain ID to 2, domain name to b, ring port to 1, 2, station type to master, DT-Ring+ to disable, do not set backup port, as shown in Figure 121;

**7.5.2 DRP****7.5.2.1 Overview**

Kyland develops the Distributed Redundancy Protocol (DRP) for data transmission on ring-topology networks. It can prevent broadcast storms for ring networks. When a link or node is faulty, the backup link can take over services in real time to ensure continuous data transmission.

Compliant with the IEC 62439-6 standard, DRP uses the master election mechanism with no fixed master. DRP provides the following features:

➤ Network scale-independent recovery time

DRP achieves network scale-independent recovery time by optimizing the ring detection packet forwarding mechanism. DRP enables networks to recover within 20ms, with the introduction of real-time reporting interruption, improving reliability for real-time data transmission. This feature enables switches to provide higher reliability for the applications in the power, rail transit, and many other industries that require real-time control.

➤ Diversified link detection functions

To improve network stability, DRP provides diversified link detection functions for typical network faults, including fast disconnection detection, optical fiber unidirectional link detection, link quality inspection, and equipment health check, ensuring proper data transmission.

➤ Applicable to multiple network topologies

Besides rapid recovery for simple ring networks, DRP also supports complex ring topologies, such as intersecting rings and tangent rings. Additionally, DRP supports VLAN-based

multiple instances, thereby suiting various network applications with flexible networking.

➤ Powerful diagnosis and maintenance functions

DRP provides powerful status query and alarm mechanisms for network diagnosis and maintenance, as well as mechanism for preventing unintended operation and incorrect configurations that may lead to ring network storms.

### 7.5.2.2 Concept

#### 1. DRP Modes

DRP involves two modes: DRP-Port-Based and DRP-VLAN-Based.

DRP-Port-Based: forwards or blocks packets based on specific ports.

DRP-VLAN-Based: forwards or blocks packets based on VLANs. If a port is in blocking state, only the data packets of the specified VLAN are blocked. Therefore, multiple VLANs can be configured on tangent ring ports. A port can belong to different DRP rings according to VLAN configurations.

#### 2. DRP Port Statuses

Forwarding state: If a port is in forwarding state, it can receive and forward data packets.

Blocking state: If a port is in blocking state, it can receive and forward DRP packets, but not other data packets.

Primary port: indicates the ring port (on the root) whose status is configured as forwarding forcibly by user when the ring is closed.



#### Caution:

- If no primary port is configured on the root, the first port whose link status changes to up when the ring is closed is in forwarding state. The other ring port is in blocking state.
  - A port in blocking state on the Root can proactively send DRP packets.
- 

#### 3. DRP Roles

DRP determines the roles of switches by forwarding Announce packets, preventing redundancy rings to form loops.

INIT: indicates the device on which DRP is enabled and the two ring ports are in Link down state.

Root: indicates the device on which DRP is enabled and at least one ring port is in Link up state. In a ring, the Root is elected according to the vectors of Announce packets. It may change with the network topology. The Root sends its own Announce packets to other devices periodically. Statuses of ring ports: One ring port is in forwarding state and the other is in blocking state. Upon receiving the Announce packet of another device, the Root compares the vector of the packet with that of its own Announce packet. If the vector of the received packet is larger, the Root changes its role to Normal or B-Root according to the link status and CRC degradation of ports.

B-Root: indicates the device on which DRP is enabled, meeting at least one of the following conditions: one ring port is in Link up state while the other is in Link down, CRC degradation, the priority is not less than 200. The B-Root compares and forwards Announce packets. If the vector of a received Announce packet is smaller than that of its own announce packet, the B-Root changes its role to Root; otherwise, it forwards the received packet and does not change its own role. Statuses of ring ports: One ring port is in forwarding state.

Normal: indicates the device on which DRP is enabled and both ring ports are in Link up state without CRC degradation and the priority is more than 200. The Normal only forwards Announce packets, but does not check the content of packets. Statuses of ring ports: Both ring ports are in forwarding state.



**Note:**

CRC degradation: indicates that the number of CRC packets exceed the threshold in 15 minutes.

**7.5.2.3 Implementation**

Each switch maintains its own vector of Announce packet. The switch with the larger vector will be elected as the Root.

The vector of Announce packet contains the following information for role assignment.

Table 5 Vector of Announce Packet

Link	CRC degradation	Role	IP address of	MAC address
------	-----------------	------	---------------	-------------

status	CRC degradation status	CRC degradation rate	priority	the device	of the device
--------	------------------------	----------------------	----------	------------	---------------

Link status: The value is set to 1 if one ring port is in Link down state and set to 0 if both ring ports are in Link up state.

CRC degradation status: If CRC degradation occurs on one port, the value is set to 1. If CRC degradation does not occur on the two ring ports, the value is set to 0.

CRC degradation rate: The ratio of the number of CRC packets and the threshold in 15 minutes.

Role priority: The value can be set on the Web UI.

The parameters in Table 5 Vector of Announce Packet are compared in the following procedure:

1. The value of link status is checked first. The device with a larger link status value is considered to have a larger vector.
2. If the two compared devices have the same link status value, the values of CRC degradation status are compared. The device with a larger CRC degradation status value is considered to have a larger vector. If the CRC degradation status value of all compared devices is 1, the device with a larger CRC degradation rate value is considered to have a larger vector.
3. If the two compared devices have the same link status value and CRC degradation value, the values of role priority, IP addresses, and MAC addresses are compared sequentially. The device with a larger value is considered to have a larger vector.
4. The device with the larger vector is elected as the Root.



**Note:**

Only when CRC degradation status value is 1, the CRC degradation rate value participates in vector comparison. Otherwise, the vectors are compared regardless of CRC degradation rate value.

➤ Implementation of DRP-Port-Based mode

The roles of switches are as follows:

1. Upon startup, all switches are in INIT state. When the state of one port changes to Link up, the switch becomes the Root and sends Announce packets to the other switches in the ring for election.
2. The switch with the largest vector of Announce packet is elected as the Root. The ring port that links up first on the Root is in forwarding state and the other ring port is in blocking state. Among the other switches in the ring, the switch with one ring port in Link down or CRC degradation state is the B-Root. The switch with both ring ports in Link up state and no CRC degradation is the Normal.

The fault recovery procedure is shown in Figure 125 :

1. In the initial topology, A is the Root; port 1 is in forwarding state and port 2 in blocking state. B, C, and D are Normal(s), and their ring ports are in forwarding state.
2. When link CD is faulty, DRP changes the statuses of port 6 and port 7 to blocking. As a result, C and D become the Roots. Because A, C, and D are Roots at the moment, they all send Announce packets. The vectors of C and D are larger than that of A because port 7 and port 6 are in Link down status. In this case, if the vector of D is larger than that of C, D is elected as the Root and C becomes the B-Root. When receiving the Announce packet of D, A finds that the vector of D is larger than its own vector and both its ring ports are in Link up state. Therefore, A becomes a Normal and changes the status of port 2 to forwarding.
3. When link CD recovers, D is still the Root because its vector is larger than the vector of C.
  - If no primary port is configured on D, port 7 is still in blocking state and port 8 is in forwarding state.
  - If port 7 on D is configured as primary port, port 7 changes to forwarding state and port 8 is in blocking state.

DRP changes the state of port 6 to forwarding. As a result, C becomes a Normal. Therefore, the roles of switches do not change for link recovery.

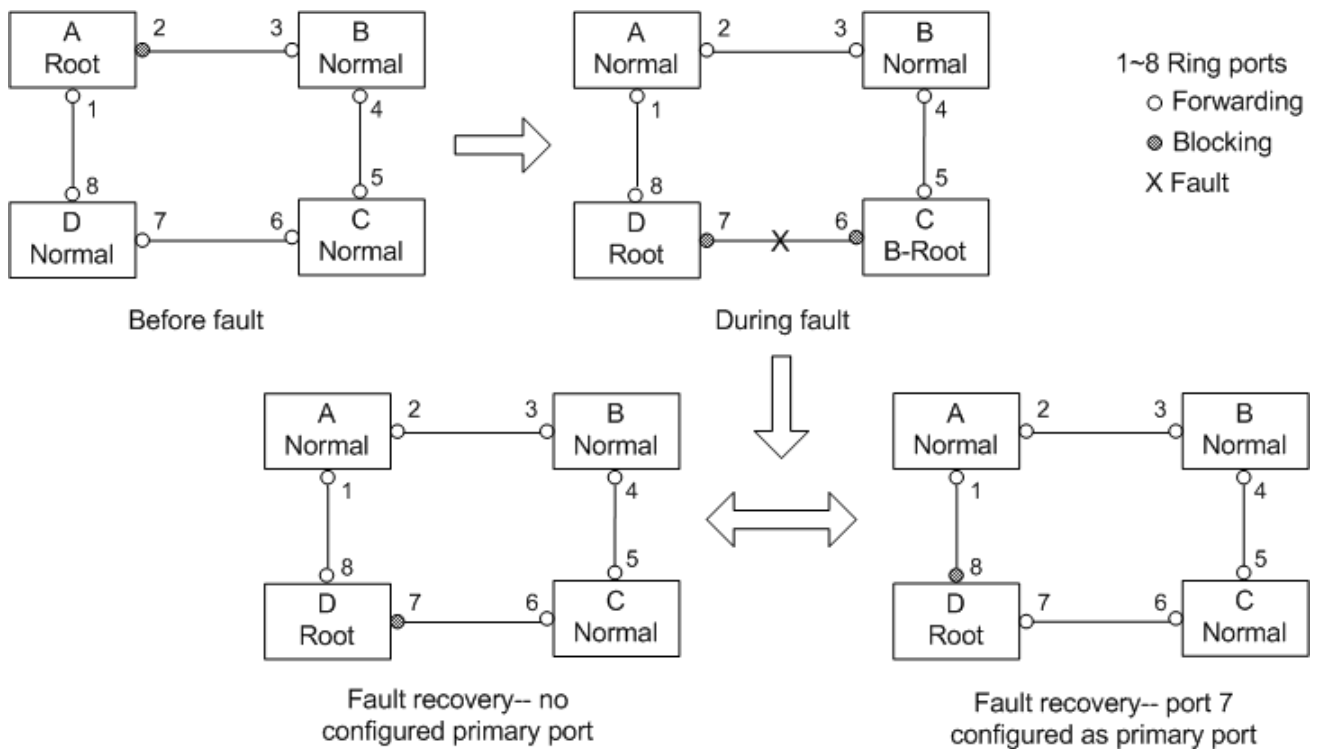

Figure 125 DRP Link Fault



**Note:**

On a DRP ring network, the roles of switches change upon a link fault, but do not change when the link recovers. This mechanism improves network security and reliability of data transmission.

➤ Implementation of DRP-VLAN-Based mode

DRP-VLAN-Based ring allows the packets of different VLANs to be forwarded in different paths. Each forwarding path for a VLAN forms a DRP-VLAN-Based. Different DRP-VLAN-Based ring can have different roots. As shown in the following figure, two DRP-VLAN-Based rings are configured.

Ring links of DRP-VLAN10/20-Based: AB-BC-CD-DE-EA.

Ring links of DRP-VLAN30-Based: FB-BC-CD-DE-EF.

The two rings are tangent at link BC, CD, and DE. Switch C and Switch D share the same ports in the two rings, but use different logical links based on VLANs

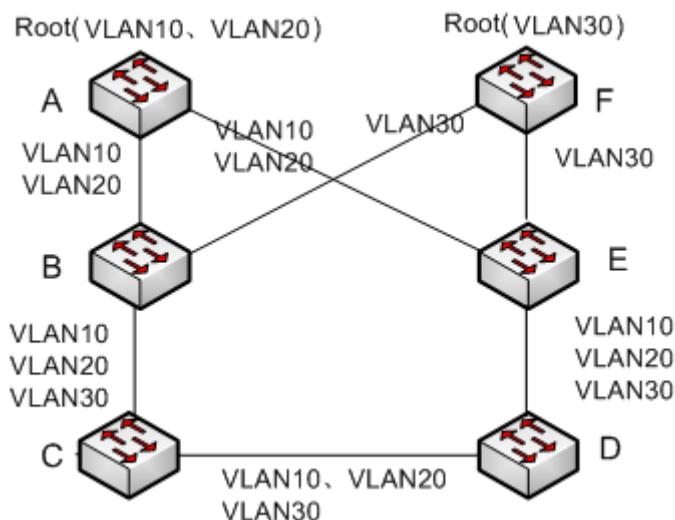

Figure 126 DRP-VLAN-Based



**Note:**

The port status and role assignment of each DRP-VLAN-Based ring are the same as those of DRP-Port-Based ring.

➤ DRP Backup

DRP can also provide backup for two DRP rings, preventing loops and ensuring normal communication between rings.

Backup port: indicates the communication port between DRP rings. Multiple backup ports can be configured, but must be in the same ring. The first backup port that links up is the master backup port, which is in forwarding state. All the other backup ports are slave. They are in blocking state.

As shown in Figure 127, one backup port can be configured on each switch. The master backup port is in forwarding state and the other backup ports are in blocking state. If the master backup port or its link is faulty, a slave backup port will be selected to forward data.



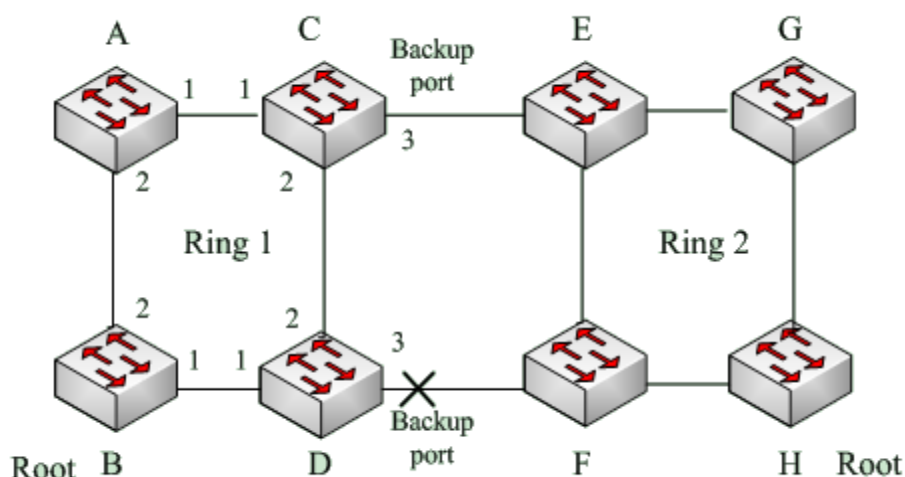

Figure 127 DRP Backup



**Caution:**

Link status change affects the status of backup ports.

### 7.5.3 DHP

#### 7.5.3.1 Overview

As shown in Figure 128, A, B, C, and D are mounted to a ring. Dual Homing Protocol (DHP) achieves the following functions if it is enabled on A, B, C, and D:

- A, B, C, and D can communicate with each other, without affecting the proper running of devices in the ring.
- If the link between A and B is faulty, A can still communicate with B, C, and D by way of Device 1 and Device 2.

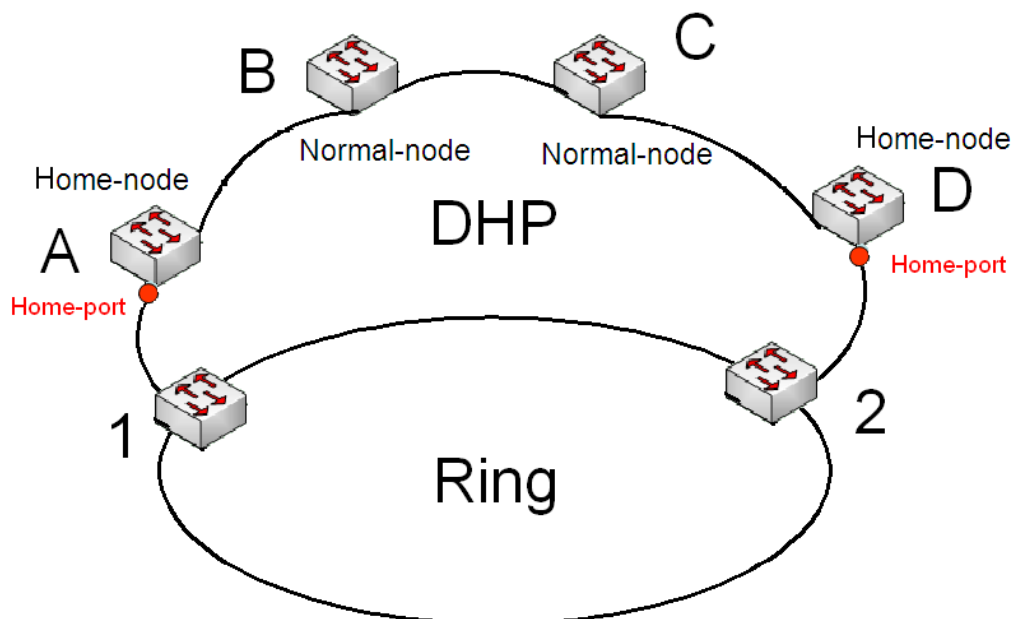

Figure 128 DHP Application

### 7.5.3.2 Concepts

The implementation of DHP is based on DRP. The role election and assignment mechanism of DHP is the same as that of DRP. DHP provides link backup through the configuration of Home-node, Normal-node, and Home-port.

Home-node: indicates the devices at both ends of the DHP link and terminates DRP packets.

Home-port: indicates the port connecting a Home node to the external network. A Home-port provides the following functions:

- Sending response packets to the Root upon receiving Announce packets from the Root. The Root identifies the ring status as closed if it receives response packets. If the Root does not receive response packets, it identifies the ring status as open.
- Blocking the DRP packets of external networks and isolating the DHP link from external networks.
- Sending entry clearing packets to connected devices on external networks upon a topology change of the DHP link.

Normal-node: indicates the devices in the DHP link, excluding the devices at both ends.

Normal-nodes transmit the response packets of Home-nodes.

### 7.5.3.3 Implementation

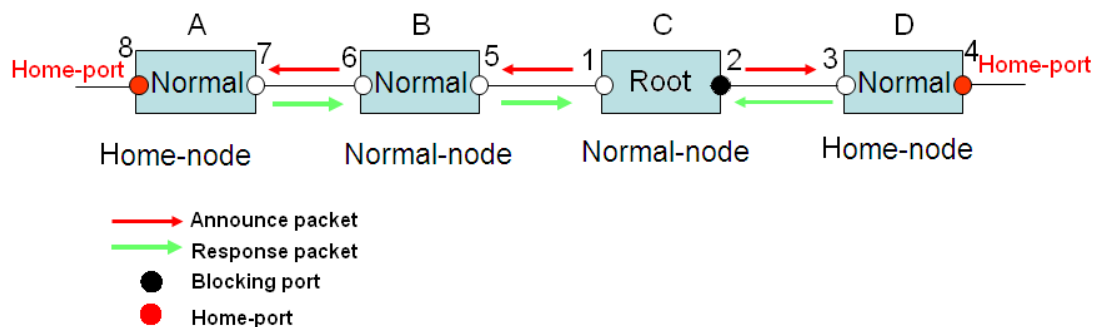

Figure 129 DHP Configuration

As shown in Figure 128, the configurations of A, B, C, and D in Figure 129 are as follows:

- DRP configuration: C is the Root; port 2 is in blocking state; A, B, and D are Normal; all the other ring ports are in forwarding state.
- DHP configuration: A and D are Home-nodes; port 8 and port 4 are Home-ports; B and C are Normal-nodes.

Implementation:

1. C, the Root, sends Announce packets through its two ring ports. Home-port 8 and Home-port 4 terminate the received Announce packets and send response packets to C. C identifies the ring status as closed. Port 2 is in blocking state.
2. When the link between A and B is blocked, the topology involves two links: A and B-C-D.
  - A is elected as the Root. Port 7 is in blocking state.
  - In link B-C-D, B is elected as the Root. Port 6 is in blocking state. C becomes the Normal. Port 2 is forwarding state. A can communicate with B, C, and D by way of Device 1 and Device 2, as shown in Figure 130.

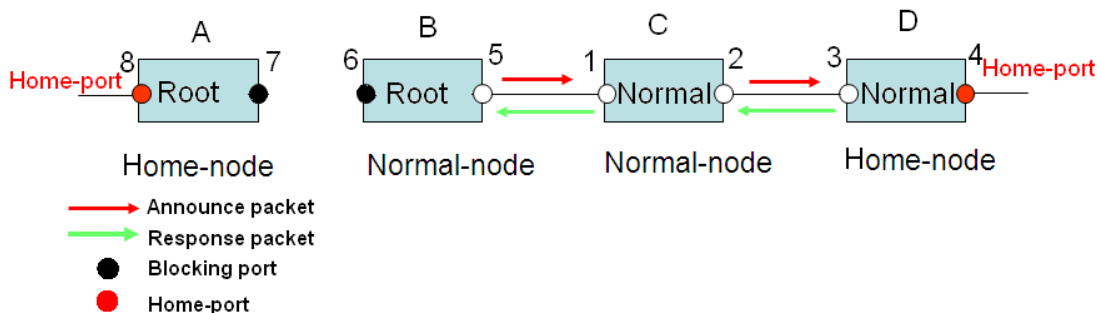

Figure 130 DHP Fault Recovery

### 7.5.3.4 Description

DRP configurations meet the following requirements:

- All switches in the same ring must have the same domain number.
- One ring contains only one Root, but can contain multiple B-Roots or Normal(s).
- Only two ports can be configured on each switch for a ring.
- For two connected rings, backup ports can be configured only in one ring.
- Multiple backup ports can be configured in one ring.
- On a switch, only one backup port can be configured for one ring.

### 7.5.3.5 Web Configuration

1. Configure the DRP redundancy mode, as shown in Figure 131.

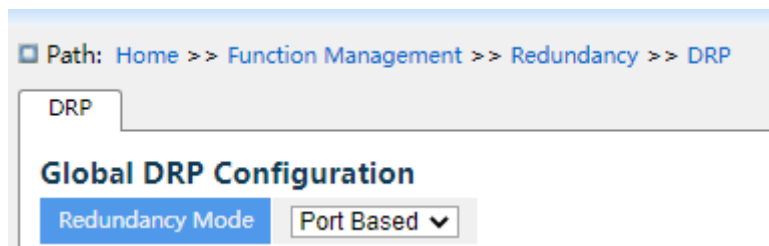

Figure 131 Configure the DRP Redundancy Mode

#### Redundancy Mode

Configuration options: Port Based/Vlan Based

Default configuration: Port Based

Function: Configure the DRP redundancy mode.



**Caution:**

- Port-based ring protocols include RSTP, DT-Ring-Port, and DRP-Port, and VLAN-based ring protocols include MSTP, DT-Ring-VLAN, and DRP-VLAN.
- VLAN-based ring protocols are mutually exclusive, and only type of VLAN-based ring protocol can be configured for one device.
- Port-based ring protocol and VLAN-based ring protocol are mutually exclusive, and only one ring protocol mode can be selected for one device.

2. Configure DRP-Port-Based and DRP-VLAN-Based, as shown in Figure 132 and Figure

133.

DRP Configuration

All	Domain ID	Domain Name	Ring Port-1	Ring Port-2	Primary Port	DHP Mode	DHP Home Port	CRC Threshold	Role Priority	Backup Port	Vlan List	Protocol Vlan ID	Protocol Enable
<input type="checkbox"/>	1	aaa	1	2	Ring Port-1	Normal-Node	---	100	128	---			<input type="checkbox"/>

Figure 132 DRP-Port-Based Configuration

DRP Configuration

All	Domain ID	Domain Name	Ring Port-1	Ring Port-2	Primary Port	DHP Mode	DHP Home Port	CRC Threshold	Role Priority	Backup Port	Vlan List	Protocol Vlan ID	Protocol Enable
<input type="checkbox"/>	1	bbb	1	2	Ring Port-1	Normal-Node	---	100	128	---	1	1	<input type="checkbox"/>

Figure 133 DRP-VLAN-Based Configuration

**Domain ID**

Configuration range: 1~32

Function: Each ring has a unique domain ID. One switch supports a maximum of 8 VLAN-based rings, the number of port-based rings depends on the number of switch ports.

**Domain Name**

Configuration range: 1~31 characters

Function: Configure the domain name.

**Ring Port-1/Ring Port-2**

Configuration options: all switch ports

Function: Select two ring ports.



**Caution:**

- DRP ring port or backup port and port channel are mutually exclusive. A DRP ring port or backup port cannot be added to a port channel; a port in a port channel cannot be configured as a DRP ring port or backup port.
- Ring ports between port-based ring protocols RSTP, DT-Ring-Port, and DRP-Port are mutually exclusive, that is, the ring port and backup port of DRP-Port cannot be configured as RSTP port; RSTP port cannot be configured as DRP-Port ring port or backup port.

**Primary Port**

Configuration options: --/Ring Port-1/Ring Port-2

Default configuration: --

Function: Configure the primary port. When the ring is closed, the primary port on root is in

forwarding state.

### **DHP Mode**

Configuration options: Disable/Normal-Node/Home-Node

Default configuration: Disable

Function: Disable DHP or configure the DHP mode.

### **DHP Home Port**

Configuration options: Ring-Port-1/Ring-Port-2/Ring-Port-1-2

Function: Configure the Home-port for a DHP Home-node.

Description: If there is only one device in DHP link, the both ring ports of the Home-node must be configured as the Home-port.

### **CRC Threshold**

Configuration range: 25~65535

Default configuration: 100

Function: Configure the CRC threshold.

Description: This parameter is used in root election. The system counts the number of received CRCs. If the number of CRCs of one ring port exceeds the threshold, the system considers the port to have CRC degradation. As a result, the CRC degradation value is set to 1 in the vector of the Announce packet of the port.

### **Role Priority**

Configuration range: 0~255

Default configuration: 128

Function: Configure the priority of a switch.

### **Backup Port**

Configuration options: all switch ports

Function: Configure the backup port.



#### **Caution:**

Do not configure a ring port as a backup port.

---

## **VLAN List**

Configuration options: All created VLANs

Function: Select the VLANs managed by current DRP-VLAN-Based ring.

**Protocol Vlan ID**

Configuration range: 1~4093

Description: The VLAN ID must be one of service VLAN.

Function: DRP packets with the VLAN ID serve as the basis for the diagnosis and maintenance of the DRP-VLAN-Based ring.

**Protocol Enable**

Configuration options: Enable/Disable

Function: Enable the DRP protocol for the specified domain

3. View and modify DRP configuration, as shown below.

DRP Configuration

All	Domain ID	Domain Name	Ring Port-1	Ring Port-2	Primary Port	DHP Mode	DHP Home Port	CRC Threshold	Role Priority	Backup Port	Vlan List	Protocol Vlan ID	Protocol Enable	
<input type="checkbox"/>	1	aaa	1	2	Ring Port-1	Disable	---	100	128	---			<input type="checkbox"/>	Details

Figure 134 View and Modify DRP Configuration

Select a DRP entry, click <Modify> to edit the DRP entry configuration; click <Delete> to delete the designated DRP entry.

4. Out-Home-Port Configuration ,as shown below.



Figure 135 Out-Home-Port Configuration

**Port**

Configuration scope: All ports of the switch

Function: The dual attribution detection mechanism combined with the standard RSTP (Rapid spanning tree protocol) ring protocol enables dual attribution links and prevents temporary loops when intermediate links are up and down, and enables fast switching of forwarding paths. When DHP Port is enabled, the ring formed by the down-link and the main ring will be in ring-close state, ensuring normal communication between all devices.

5. Click Details in the DRP entry in Figure 134 to show the roles and port status of the switches in the DRP ring, as shown in Figure 136.

Path: Home >> Function Management >> Redundancy >> DRP : DRP -> DRP Information

DRP Information

[<<Back](#)

Domain ID	1
Domain Name	123
Role State	NULL
Ring Port-1	
Ring Port-2	
Primary Port	Ring Port-1
DHP Mode	Disable
DHP Home Port	---
CRC Threshold	100
Role Priority	128
Backup Port	---   ---

Figure 136 DRP State

### 7.5.3.6 Typical Configuration Example

As shown in Figure 127, A, B, C, and D form Ring 1; E, F, G, and H form Ring 2; CE and DF are the backup links of Ring 1 and Ring 2.

#### Configuration on switch A and switch B:

1. Set Domain ID to 1 and Domain name to a. Select ring port 1 and ring port 2. Keep default values for role priority and backup port, as shown in Figure 132.

#### Configuration on switch C and switch D:

2. Set Domain ID to 1, Domain name to a, and Backup port to 3. Select ring port 1 and ring port 2. Keep the default value for role priority, as shown in Figure 132.

#### Configuration on switch E, F, G, and H:

3. Set Domain ID to 2 and Domain name to b. Select ring port 1 and ring port 2. Keep default values for role priority and backup port, as shown in Figure 132.



## 7.5.4 RSTP/STP Configuration

### 7.5.4.1 Introduction

Standardized in IEEE802.1D, the Spanning Tree Protocol (STP) is a LAN protocol used for preventing broadcast storms caused by link loops and providing link backup. STP-enabled devices exchange packets and block certain ports to prune "loops" into "trees", preventing proliferation and endless loops. The drawback of STP is that a port must wait for twice the forwarding delay to transfer to the forwarding state.

To overcome the drawback, IEEE creates 802.1w standard to supplement 802.1D.

IEEE802.1w defines the Rapid Spanning Tree Protocol (RSTP). Compared with STP, RSTP achieves much more rapid convergence by adding alternate port and backup port for the root port and designated port respectively. When the root port is invalid, the alternate port can enter the forwarding state quickly.

### 7.5.4.2 Concepts

**Root bridge:** serves as the root for a tree. A network has only one root bridge. The root bridge changes with network topology. The root bridge periodically sends BPDU to the other devices, which forward the BPDU to ensure topology stability.

**Root port:** indicates the best port for transmission from the non-root bridges to the root bridge. The best port is the port with the smallest cost to the root bridge. A non-root bridge communicates with the root bridge through the root port. A non-root bridge has only one root port. The root bridge has no root port.

**Designated port:** indicates the port for forwarding BPDU to other devices or LANs. All ports on the root bridge are designated ports.

**Alternate port:** indicates the backup port of the root port. If the root port fails, the alternate port becomes the new root port.

**Backup port:** indicates the backup port of the designated port. When a designated port fails, the backup port becomes the new designated port and forwards data.

### 7.5.4.3 BPDU Configuration Messages

To prevent loops, all the bridges of a LAN calculate a spanning tree. The calculation process involves transmitting BPDUs among devices to determine the network topology. Table 6 shows the data structure of a BPDU.

Table 6 BPDU

...	Root bridge ID	Root path cost	Designated bridge ID	Designated port ID	Message age	Max age	Hello time	Forward delay	...
...	8 bytes	4 bytes	8 bytes	2 bytes	2 bytes	2 bytes	2 bytes	2 bytes	...

Root bridge ID: priority of the root bridge (2 bytes) +MAC address of the root bridge (6 bytes).

Root path cost: cost of the path to the root bridge.

Designated bridge ID: priority of the designated bridge (2 bytes) +MAC address of the designated bridge (6 bytes).

Designated port ID: port priority+port number.

Message age: duration that a BPDU can be spread in a network.

Max age: maximum duration that a BPDU can be saved on a device. When Message age is larger than Max age, the BPDU is discarded.

Hello time: interval for sending BPDUs.

Forward delay: status change delay (discarding--learning or learning--forwarding).

### 7.5.4.4 Implementation

The process for all bridges calculating the spanning tree with BPDUs is as follows:

1. In the initial phase

Each port of all devices generates the BPDU with itself as the root bridge; both root bridge ID and designated bridge ID are the ID of the local device; the root path cost is 0; the designated port is the local port.

2. Best BPDU selection

All devices send their own BPDUs and receive BPDUs from other devices. Upon receiving a

BPDU, each port compares the received BPDU with its own.

- If the priority of its own BPDU is higher, then the port does not perform any operation.
- If the priority of the received BPDU is higher, then the port replaces the local BPDU with the received one.

Devices compare the BPDUs of all ports and figure out the best BPDU. Principles for comparing BPDUs are as follows:

- The BPDU with a smaller root bridge ID has a higher priority.
- If the root bridge IDs of two BPDUs are the same, their root path costs are compared. If the root path cost in a BPDU plus the path cost of the local port is smaller, then the priority of the BPDU is higher.
- If the root path costs of two BPDUs are also the same, the designated bridge IDs, designated port IDs, and IDs of the port receiving the BPDUs are further compared in order. The BPDU with a smaller ID has a higher priority. The BPDU with a smaller root bridge ID has a higher priority.

### 3. Selection of the root bridge

The root bridge of the spanning tree is the bridge with the smallest bridge ID.

### 4. Selection of the root port

A non-root-bridge device selects the port receiving the best BPDU as the root port.

### 5. BPDU calculation of the designated port

Based on the BPDU of the root port and the path cost of the root port, a device calculates a designated port BPDU for each port as follows:

- Replace the root bridge ID with the root bridge ID of the BPDU of the root port.
- Replace the root path cost with the root path cost of the root port BPDU plus the path cost of the root port.
- Replace designated bridge ID with the ID of the local device.
- Replace the designated port ID with the ID of the local port.

### 6. Selection of the designated port

If the calculated BPDU is better, then the device selects the port as the designated port, replaces the port BPDU with the calculated BPDU, and sends the calculated BPDU. If the port BPDU is better, then the device does not update the port BPDU and blocks the port.

Blocked ports can receive and forward only RSTP packets, but not other packets.

### 7.5.4.5 Web Configuration

1. Set the time parameters of the network bridge, as shown below.

Path: Home >> Function Management >> Redundancy >> Spanning Tree : Bridge Settings

Bridge Settings	MSTI Mapping	MSTI Priorities	CIST Ports	MSTI Ports	Bridge Status	Port Status	Port Statistics
Enable	<input checked="" type="checkbox"/>						
Protocol Version	MSTP ▼						
Bridge Priority	32768 ▼						
Hello Time	2	(Second(s))					
Forward Delay	15	(Second(s))					
Max Age	20	(Second(s))					
Maximum Hop Count	20						
Transmit Hold Count	6						
Edge Port BPDU Filtering	<input type="checkbox"/>						
Port Error Recovery	<input type="checkbox"/>						
Port Error Recovery Timeout		(Second(s))					

Apply

Figure 137 Setting Time Parameters of the Network Bridge

### Global Configuration

Configuration options: Enable/Disable

Default configuration: Disable

Function: Disable or enable spanning tree.



**Caution:**

- Port-based ring protocols include RSTP and VLAN-based ring protocols include MSTP and DRP-VLAN.
- Port-based ring protocol and VLAN-based ring protocol are mutually exclusive, and only one ring protocol mode can be selected for one device.

### Protocol Priority

Configuration options: MSTP/RSTP/STP

Default configuration: MSTP

Function: Select the spanning tree protocol.

### Bridge Priority

Configuration range: 0~61440. The step is 4096.

Default configuration: 32768

Function: Configure the priority of the network bridge.

Description: The priority is used for selecting the root bridge. The smaller the value, the higher the priority.

### Hello Time

Configuration range: 1~10s

Default configuration: 2s

Function: Configure the interval for sending BPDU.

### Forward Delay

Configuration range: 4~30s

Default configuration: 15s

Function: Configure status change time from Discarding to Learning or from Learning to Forwarding.

### Max Age

Configuration range: 6~40s

Default configuration: 20s

Function: Maximum duration that a BPDU can be saved on a device.

Description: If the value of message age in the BPDU is larger than the specified value, then the BPDU is discarded.



#### Caution:

- The values of Forward Delay Time, Hello Time and Max Age Time should meet the following requirements:  $2 * (\text{Forward Delay Time} - 1.0 \text{ seconds}) \geq \text{Max Age Time}$ ;  $\text{Max Age Time} \geq 2 * (\text{Hello Time} + 1.0 \text{ seconds})$ .
  - The default setting is recommended.
- 

### Maximum Hop Count

Configuration range: 6~40

Default configuration: 20

Function: Configure the maximum hops of MST region. The maximum hops of MST region limit the scale of MST region; the maximum number of hops of regional root is the maximum number of hops of MST region.

Description: Starting from the root bridge of spanning tree in MST region, the hop number deducts 1 when the BPDU passes through a device in the region. Device drops the BPDU with the hop number of 0.



**Caution:**

- Only the maximum hop configuration of root bridge in MST region is valid. Non-root bridge device adopts the maximum hop configuration of root bridge.
  - The default setting is recommended.
- 

### **Transmit Hold Count**

Configuration range: 1~10

Default configuration: 6

Function: Set the maximum number of BPDU packets that can be sent by a port within each Hello Time.

### **Edge Port BPDU Filtering**

Configuration options: Enable/Disable

Default configuration: Disable

Function: Control whether an edge port receives and forwards BPDU packets.

### **Port Error Recovery**

Configuration options: Enable/Disable

Default configuration: Disable

Function: Control whether a port can automatically recover from the error state to the normal state.

### **Port Error Recovery Timeout**

Configuration range: 30~86400s

Function: Set the time for a port to recover from the error state to the normal state.

2. Configure RSTP port, as shown below.

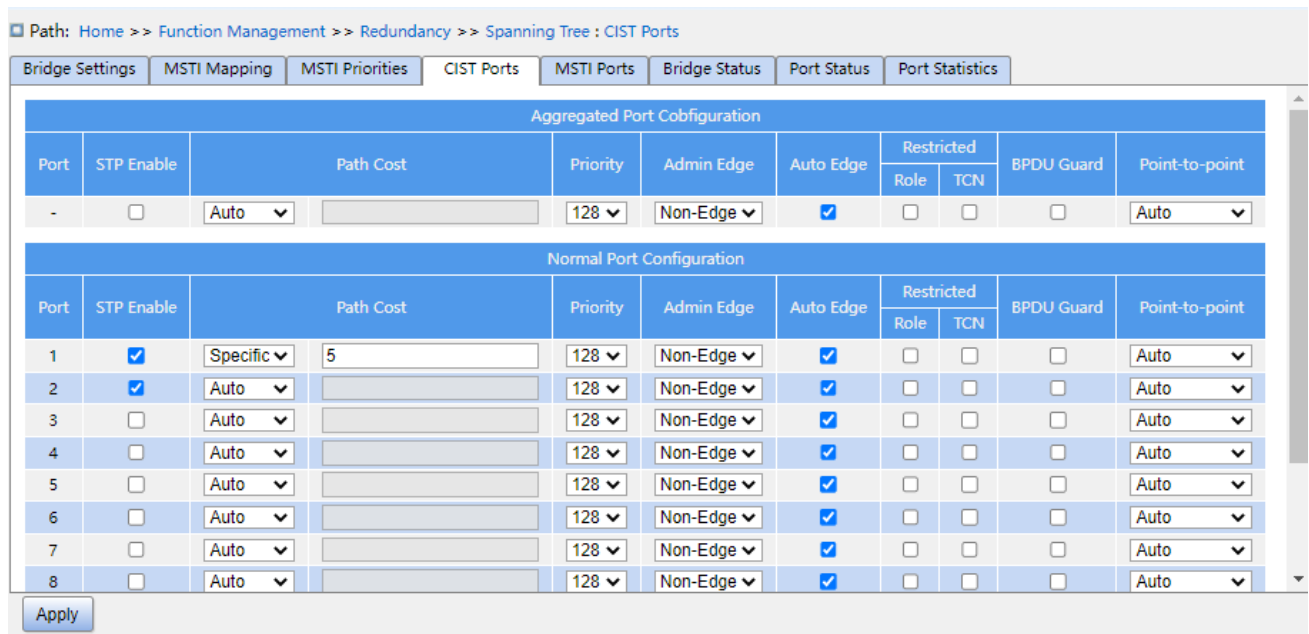

Figure 138 Configure RSTP Port

**CIST**

Function: Treats the aggregation group as a CIST port and configures its path overhead and priority in the specified instance.

**STP Enabled**

Configuration options: Enable/Disable

Default configuration: Disable

Function: Enable or disable STP/RSTP on ports.



**Caution:**

- RSTP port and port channel are mutually exclusive. A RSTP port cannot be added to a port channel; a port in a port channel cannot be configured as a RSTP port.
- Ring ports between port-based ring protocols RSTP, DT-Ring-Port, and DRP-Port are mutually exclusive, that is, a RSTP port cannot be configured as DRP-Port/DT-Ring-Port ring port, or DRP-Port/DT-Ring-Port backup port; DRP-Port/DT-Ring-Port ring port, and DRP-Port/DT-Ring-Port backup port cannot be configured as a RSTP port.

**Path Cost**

Configuration options: Auto/Specific (1~200000000)

Default configuration: Auto

Description: The path cost of a port is used to calculate the best path. The value of the parameter depends on the bandwidth. The larger the value, the lower the cost. You can change the role of a port by changing the value of the path cost parameter. To configure the value manually, select No for Cost Count.

### **Priority**

Configuration range: 0~240. The step is 16.

Default configuration: 128

Function: Configure the port priority, which determines the roles of ports.

### **Admin Edge**

Configuration options: Non-Edge/Edge

Default configuration: Non-Edge

Function: Set whether the current port is an edge port.

Description: When a port is directly connected to a terminal and is not connected to other devices or a shared network segment, the port is considered as an edge port. An edge port can rapidly migrate from the blocking state to the forwarding state without waiting delay. After an edge port receives BPDU packets, it becomes a non-edge port.

### **Auto Edge**

Configuration options: Enable/Disable

Default configuration: Enable

Function: Specify whether to enable the automatic detection function of an edge port.

### **Restricted Role**

Configuration options: Enable/Disable

Default configuration: Disable

Function: A restricted port will be never selected as a root node even if it is granted the highest priority.

### **Restricted TCN**

Configuration options: Enable/Disable

Default configuration: Disable



Function: A port with restricted TCN will not actively send TCN messages.

### **BPDU Guard**

Configuration options: Enable/Disable

Default configuration: Disable

Function: Control whether an edge port enters the Error-Disable state and is shut down when receiving BPDU packets.

### **Point-to-point**

Configuration options: Auto/Forced True/Forced False

Default configuration: Auto

Function: Set the connection type for a port. If a port is connected to a point-to-point link, the port can rapidly migrate to another state.

Description: **Auto** indicates that the switch automatically detects the link type based on the duplex status of a port. When a port works in full-duplex mode, the switch considers that the type of the link connected to the port is point-to-point; when a port works in half-duplex mode, the switch considers that the type of the link connected to the port is shared. Forced point-to-point refers that a link connected to a port is a point-to-point link and forced sharing refers that a link connected to a port is a shared link.

#### **7.5.4.6 Typical Configuration Example**

The priorities of Switch A, B, and C are 0, 4096, and 8192. Path costs of links are 4, 5, and 10, as shown in Figure 139.

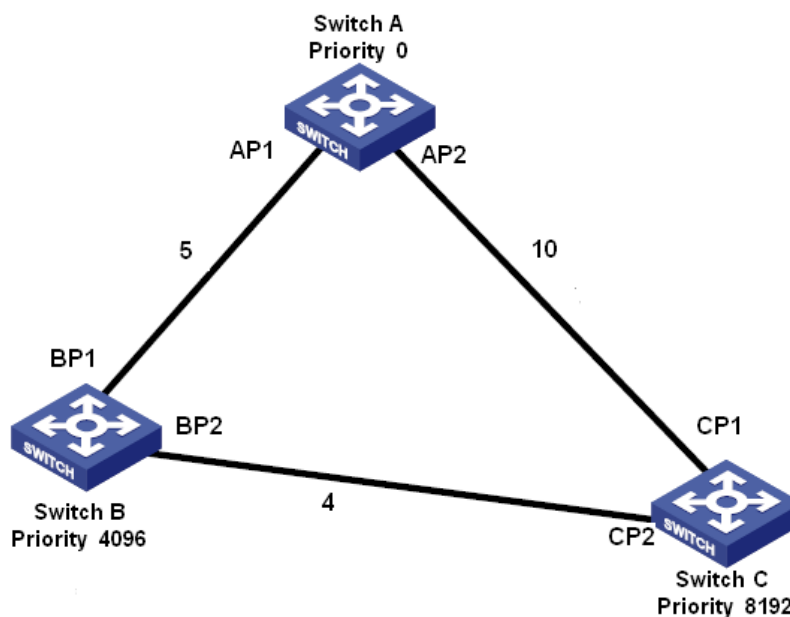

Figure 139 RSTP Configuration Example

Configuration on Switch A:

1. Set bridge priority to 0 and time parameters to default values, as shown in Figure 137.
2. Set the path cost of port 1 to 5 and that of port 2 to 10, as shown in Figure 138.

Configuration on Switch B:

1. Set bridge priority to 4096 and time parameters to default values, as shown in Figure 137.
2. Set the path cost of port 1 to 5 and that of port 2 to 4, as shown in Figure 138.

Configuration on Switch C:

1. Set bridge priority to 8192 and time parameters to default values, as shown in Figure 137.
2. Set the path cost of port 1 to 10 and that of port 2 to 4, as shown in Figure 138.

- The priority of Switch A is 0 and its root ID is the smallest. Therefore, Switch A is the root bridge.
- The path cost from AP1 to BP1 is 5 and that from AP2 to BP2 is 14. Therefore, BP1 is the root port.
- The path cost from AP1 to CP2 is 9 and that from AP2 to CP1 is 10. Therefore, CP2 is the root port and BP2 is the designated port.

## 7.5.5 MSTP Configuration

### 7.5.5.1 Introduction

Although RSTP achieves rapid convergence, it also has the following defect just as the STP: all bridges in the LAN share one spanning tree and packets of all VLANs are forwarded along the spanning tree. As shown in Figure 140, certain configurations may block the link between switch A and switch C. Because switch B and switch D are not in VLAN 1, they cannot forward the packets of VLAN 1. As a result, the VLAN 1 port of switch A cannot communicate with that of switch C.

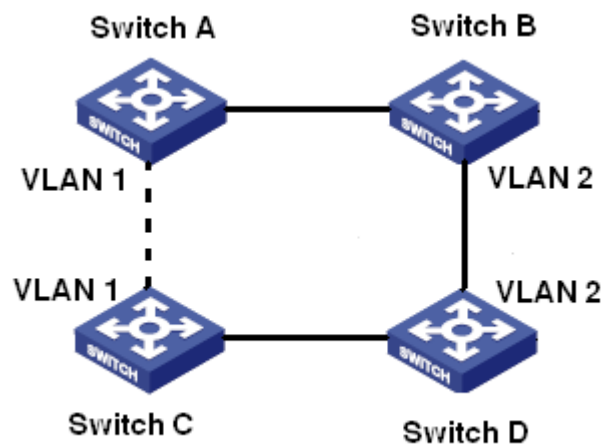

Figure 140 RSTP Disadvantage

To solve this problem, the Multiple Spanning Tree Protocol (MSTP) came into being. It achieves both rapid convergence and separate forwarding paths for the traffic of different VLANs, providing a better load sharing mechanism for redundant links.

MSTP maps one or multiple VLANs into one instance. Switches with the same configuration form a region. Each region contains multiple mutually independent spanning trees. The region serves as a switch node. It participates in the calculation with other regions based on the spanning tree algorithm, calculating an overall spanning tree. Based on this algorithm, the network in Figure 140 forms the topology shown in Figure 141. Both switch A and switch C are in Region1. No link is blocked because the region contains no loops. This is the same with Region2. Region1 and Region2 are similar to switch nodes. These two "switches" form

a loop. Therefore, a link should be blocked.

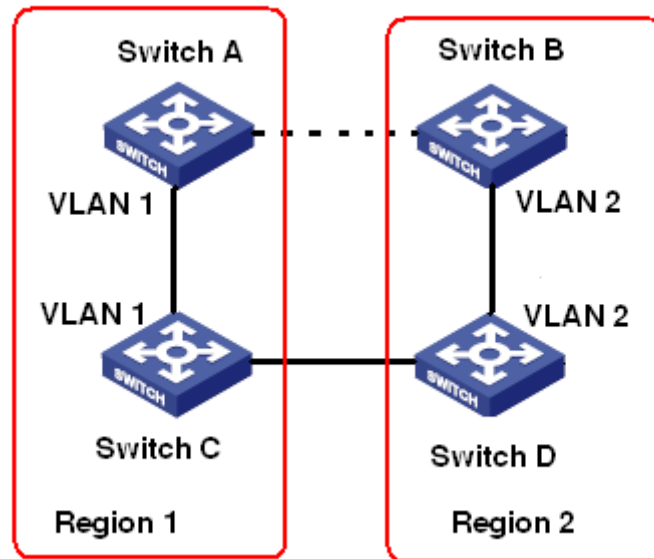

Figure 141 MSTP Topology

### 7.5.5.2 Basic Concepts

Learn MSTP concepts based on Figure 142 and Figure 145.

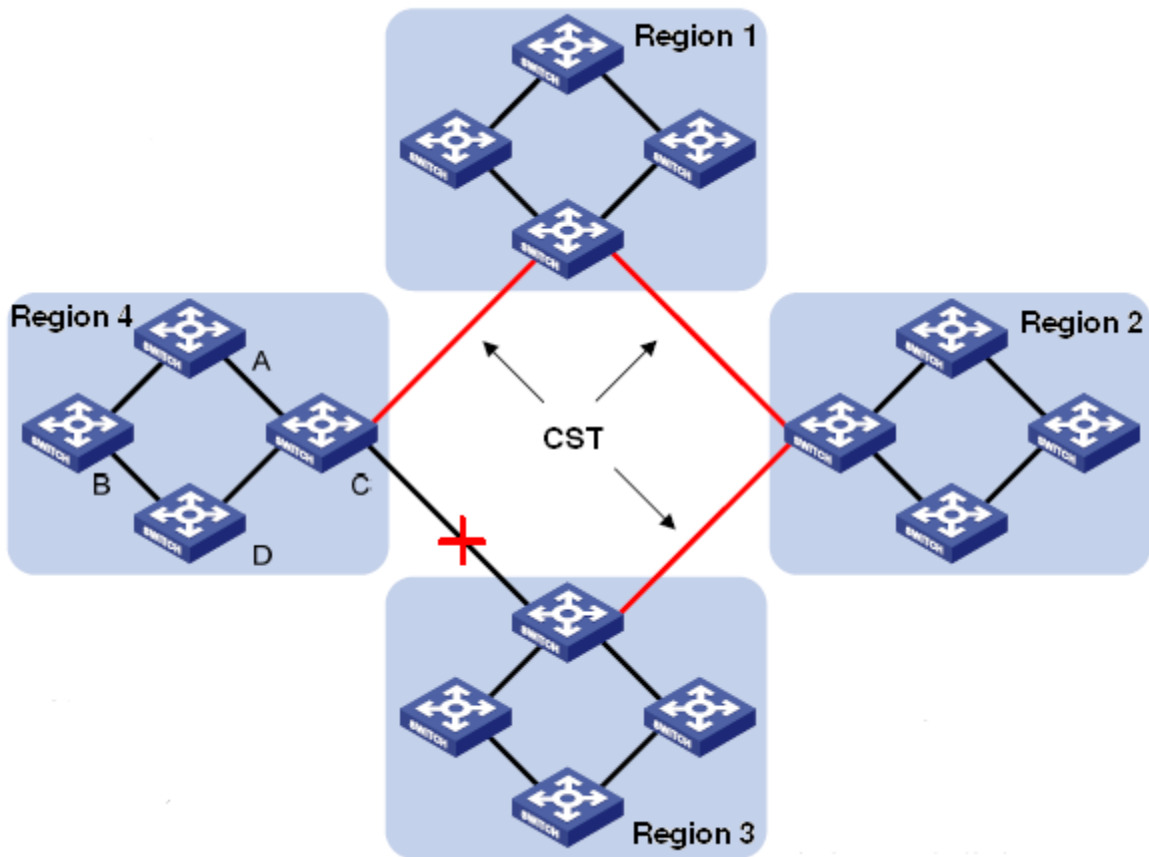

Figure 142 MSTP Concepts

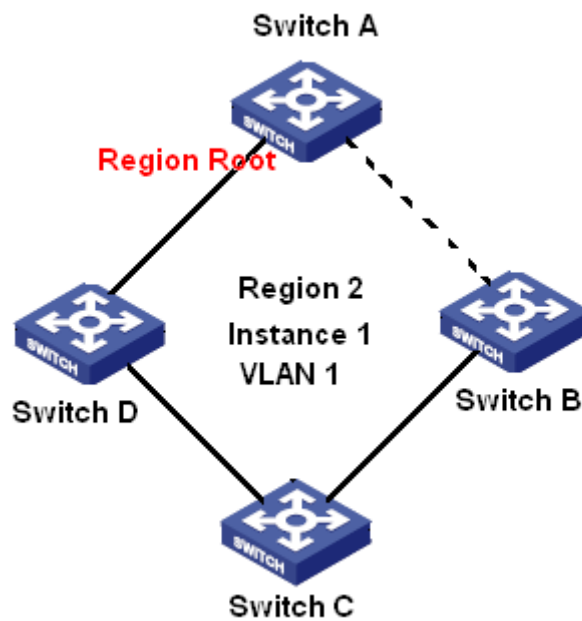

Figure 143 VLAN 1 Mapping to Instance 1

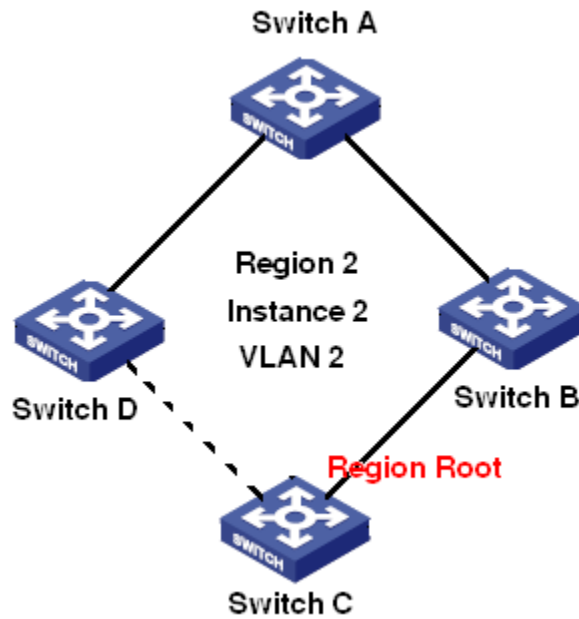

Figure 144 VLAN2 Mapping to Instance 2

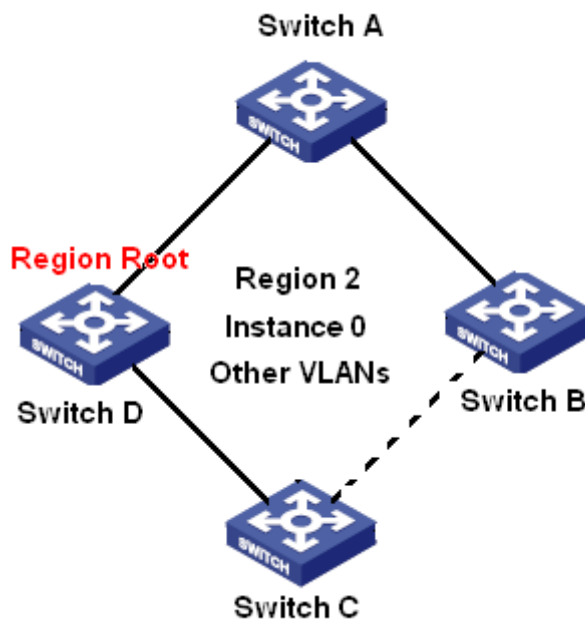

Figure 145 Other VLAN Mapping to Instance 0

Instance: a collection of multiple VLANs. One VLAN (as shown in Figure 143 and Figure 144 ) or multiple VLANs with the same topology (as shown in Figure 145 ) can be mapped to one instance; that is, one VLAN can form a spanning tree and multiple VLANs can share one spanning tree. Different instances are mapped to different spanning trees. Instance 0 is the spanning tree for the devices of all regions, while the other instances are the spanning trees for the devices of a specific region.

Multiple Spanning Tree Region (MST region): Switches with the same MSTP region name, revision level, and VLAN-to-instance mapping are in the same MST region. As shown in Figure 142 , Region1, Region2, Region3, and Region4 are four different MST regions.

VLAN mapping table: consists of the mapping between VLANs and spanning trees. In Figure 142 , VLAN mapping table of region 2 is the mapping between VLAN 1 and instance 1, as shown in Figure 143; VLAN 2 is mapped to instance 2, as shown in Figure 144. The other VLANs are mapped to instance 0, as shown in Figure 145.

Common and Internal Spanning Tree (CIST): indicates instance 0, that is, the spanning tree covering all the devices on a switching network. As shown in Figure 142 , the CIST comprises IST and CST.

Internal Spanning Tree (IST): indicates the CIST segment in the MST region, that is, instance 0 of each region, as shown in Figure 145.

Common Spanning Tree (CST): indicates the spanning tree connecting all MST regions in a switching network. If each MST region is a device node, the CST is the spanning tree calculated based on STP/RSTP by these device nodes. As shown in Figure 142, the red lines indicate the spanning tree.

MSTI (Multiple Spanning Tree Instance): one MST region can form multiple spanning trees and they are independent of each other. Each spanning tree is a MSTI, as shown in Figure 143 and Figure 144. IST is also a special MSTI.

Common root: indicates the root bridge of the CIST. The switch with the smallest root bridge ID in a network is the common root.

In an MST region, spanning trees have different topologies, and their regional roots can also be different. As shown in Figure 143, Figure 144, and Figure 145 , the three instances have different regional roots. The root bridge of the MSTI is calculated based on STP/RSTP in the current MST region. The root bridge of the IST is the device that is connected to another MST region and selected based on the priority information received.

Boundary port: indicates the port that connects an MST region to another MST region, STP running region, or RSTP running region.

Port state: A port can be in either of the following states based on whether it is learning MAC addresses and forwarding traffic.

Forwarding state: indicates that a port learns MAC addresses and forwards traffic.

Learning state: indicates that a port learns MAC addresses but does not forward traffic.

Discarding state: indicates that a port neither learns MAC addresses nor forwards traffic.

Root port: indicates the best port from a non-root bridge to the root bridge, that is, the port with the smallest cost to the root bridge. A non-root bridge communicates with the root bridge through the root port. A non-root bridge has only one root port. The root bridge has no root port. The root port can be in forwarding, learning, or discarding state.

Designated port: indicates the port for forwarding BPDU to other devices or LANs. All ports on the root bridge are designated ports. The designated port can be in forwarding, learning, or discarding state.

Master port: indicates the port that connects an MST region to the common root. The port is in the shortest path to the common root. From the CST, the master port is the root port of a region (as a node). The master port is a special boundary port. It is the root port for the CIST and master port for other instances. The master port can be in forwarding, learning, or discarding state.

Alternate port: indicates the backup port of the root port or master port. When the root port or master port fails, the alternate port becomes the new root port or master port. The master port can only be in discarding state.

Backup port: indicates the backup port of the designated port. When a designated port fails, the backup port becomes the designated port and forwards data without any delay. The backup port can only be in discarding state.

### 7.5.5.3 MSTP Implementation

MSTP divides a network into multiple MST regions. CST is calculated between regions. Multiple spanning trees are calculated in a region. Each spanning tree is an MSTI. Instance 0 is the IST, and other instances are MSTIs.

#### 1. CIST calculation

- A device sends and receives BPDU packets. Based on the comparison of MSTP configuration messages, the device with the highest priority is selected as the common root of the CIST.



- An IST is calculated in each MST region.
- Each MST region is considered as a single device and CST is calculated between regions.
- CST and IST constitute the CIST of the entire network.

## 2. MSTI calculation

In an MST region, MSTP generates different spanning trees for VLANs based on the mapping between VLANs and spanning trees. Each spanning tree is calculated independently. The calculation process is similar to that in STP.

In an MST region, VLAN packets are forwarded along corresponding MSTIs. Between MST regions, VLAN packets are forwarded along the CST.

### 7.5.5.4 Web Configuration

1. Set the time parameters of the network bridge, as shown below.

Path: Home >> Function Management >> Redundancy >> Spanning Tree : Bridge Settings

Bridge Settings	MSTI Mapping	MSTI Priorities	CIST Ports	MSTI Ports	Bridge Status	Port Status	Port Statistics
Enable	<input checked="" type="checkbox"/>						
Protocol Version	MSTP ▼						
Bridge Priority	32768 ▼						
Hello Time	2	(Second(s))					
Forward Delay	15	(Second(s))					
Max Age	20	(Second(s))					
Maximum Hop Count	20						
Transmit Hold Count	6						
Edge Port BPDU Filtering	<input type="checkbox"/>						
Port Error Recovery	<input type="checkbox"/>						
Port Error Recovery Timeout		(Second(s))					

Apply

Figure 146 Setting Time Parameters of the Network Bridge

### Global Configuration

Configuration options: Enable/Disable

Default configuration: Disable

Function: Disable or enable spanning tree.

**Caution:**

- Port-based ring protocols include RSTP, and DRP-Port, and VLAN-based ring protocols include MSTP and DRP-VLAN.
- Port-based ring protocol and VLAN-based ring protocol are mutually exclusive, and only one ring protocol mode can be selected for one device.

**Protocol Priority**

Configuration options: MSTP/RSTP/STP

Default configuration: MSTP

Function: Select the spanning tree protocol.

**Bridge Priority**

Configuration range: 0~61440. The step is 4096.

Default configuration: 32768

Function: Configure the priority of the network bridge.

Description: The priority is used for selecting the root bridge. The smaller the value, the higher the priority.

**Hello Time**

Configuration range: 1~10s

Default configuration: 2s

Function: Configure the interval for sending BPDU.

**Forward Delay**

Configuration range: 4~30s

Default configuration: 15s

Function: Configure status change time from Discarding to Learning or from Learning to Forwarding.

**Max Age**

Configuration range: 6~40s

Default configuration: 20s

Function: Maximum duration that a BPDU can be saved on a device.

Description: If the value of message age in the BPDU is larger than the specified value, then the BPDU is discarded.

---

**Caution:**

- The values of Forward Delay Time, Hello Time and Max Age Time should meet the following requirements:  $2 * (\text{Forward Delay Time} - 1.0 \text{ seconds}) \geq \text{Max Age Time}$ ;  $\text{Max Age Time} \geq 2 * (\text{Hello Time} + 1.0 \text{ seconds})$ .
  - The default setting is recommended.
- 

### Maximum Hop Count

Configuration range: 6~40

Default configuration: 20

Function: Configure the maximum hops of MST region. The maximum hops of MST region limit the scale of MST region; the maximum number of hops of regional root is the maximum number of hops of MST region.

Description: Starting from the root bridge of spanning tree in MST region, the hop number deducts 1 when the BPDU passes through a device in the region. Device drops the BPDU with the hop number of 0.

---

**Caution:**

- Only the maximum hop configuration of root bridge in MST region is valid. Non-root bridge device adopts the maximum hop configuration of root bridge.
  - The default setting is recommended.
- 

### Transmit Hold Count

Configuration range: 1~10

Default configuration: 6

Function: Set the maximum number of BPDU packets that can be sent by a port within each Hello Time.

### Edge Port BPDU Filtering

Configuration options: Enable/Disable

Default configuration: Disable

Function: Control whether an edge port receives and forwards BPDU packets.

### Port Error Recovery

Configuration options: Enable/Disable

Default configuration: Disable

Function: Control whether a port can automatically recover from the error state to the normal state.

### Port Error Recovery Timeout

Configuration range: 30~86400s

Function: Set the time for a port to recover from the error state to the normal state.

2. Configure MSTI mapping, as shown below.

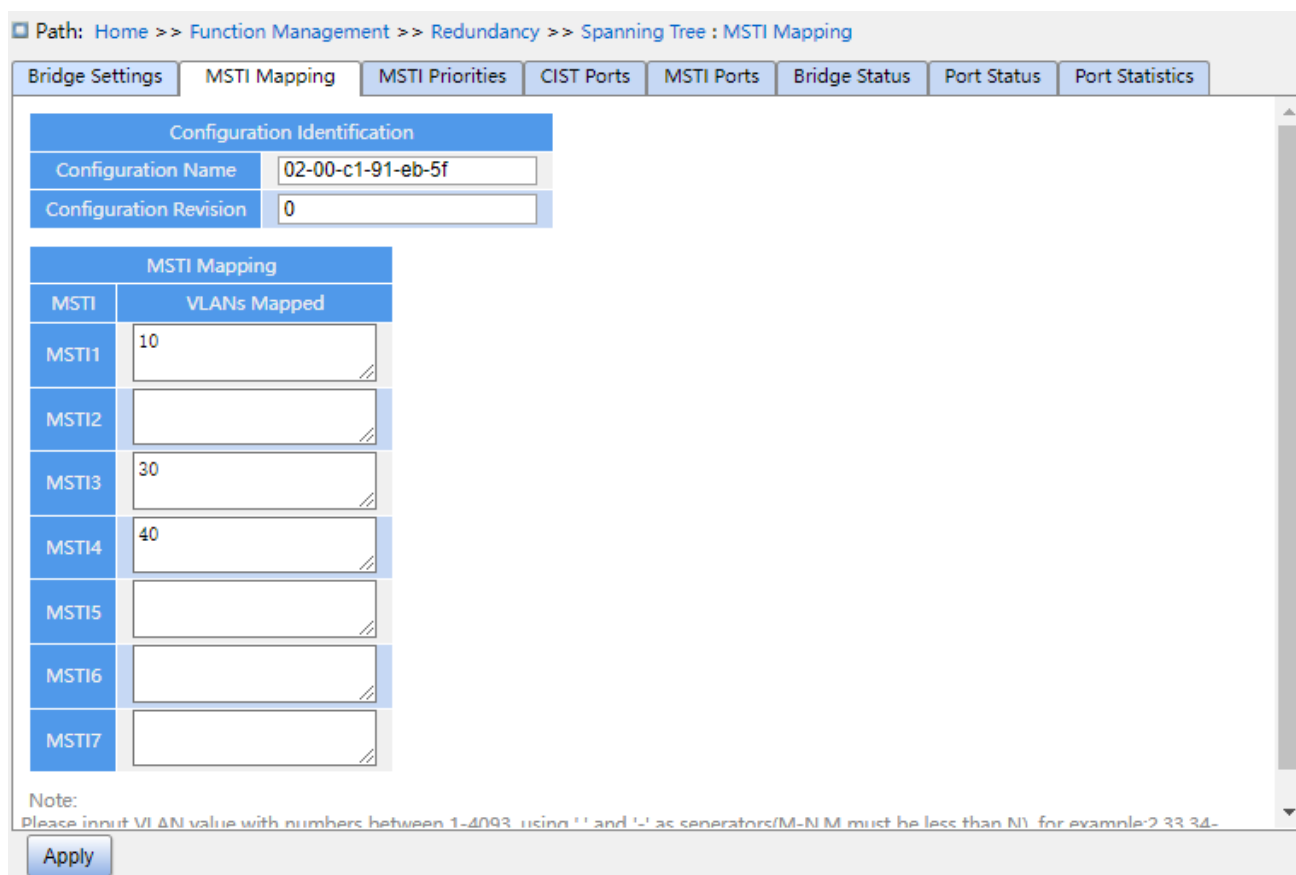

Figure 147 Configure MSTI Mapping

### Configuration Name

Configuration range: 1-32 characters

Default configuration: device MAC address

Function: Configure the name of MST region.

### Configuration Revision

Configuration options: 0~65535

Default configuration: 0

Function: Configure the revision parameter of MSTP region.

Description: Revision parameter, MST region name, and VLAN mapping table codetermines the MST region that the device belongs to. When all configurations are the same, the devices are in same MST region.

### VLANs Mapped

Configuration range: 1~4094

Function: Configure the VLAN mapping table in MST region. When there are multiple VLANs, you can separate the VLANs by a comma (,) and an en dash (-), where an en dash is used to separate two consecutive VLAN IDs and a comma is used to separate two inconsecutive VLAN IDs.

Description: By default, all VLANs map to instance 0. One VLAN maps to only one spanning tree instance. If a VLAN with an existing mapping is mapped to another instance, the previous mapping is cancelled. If the mapping between the designated VLAN and instance is deleted, this VLAN will be mapped to instance 0.

3. Configure the bridge priority of the switch in designated instance, as shown below.

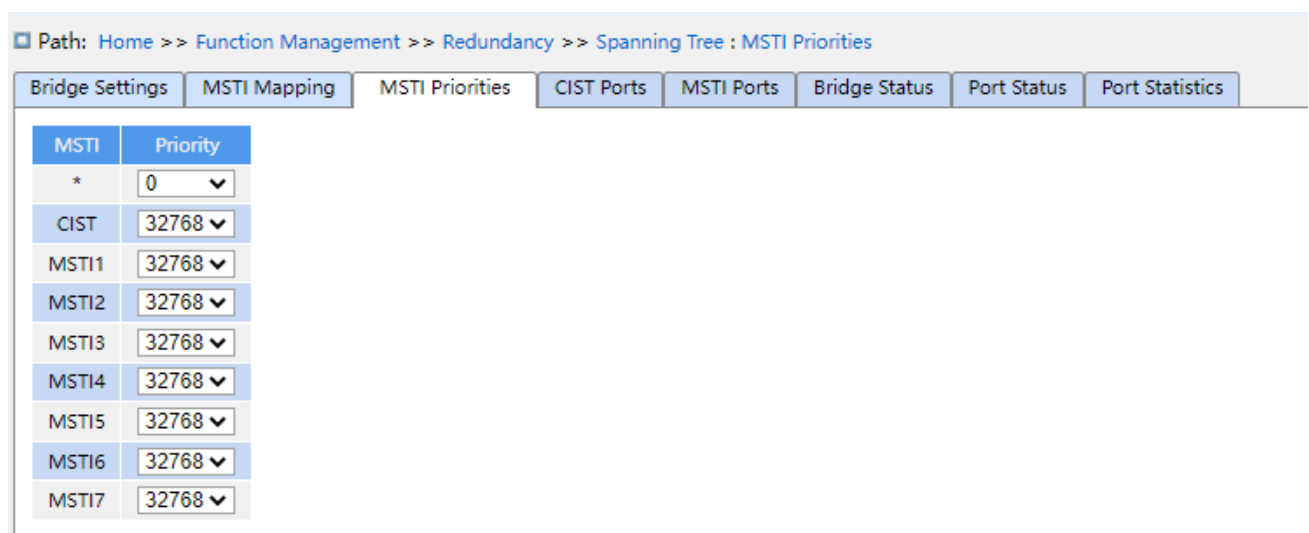

Figure 148 Configuring Bridge Priority in Designated Instance

### Priority

Configuration range: 0~61440 with the step length of 4096

Default configuration: 32768

Function: Configure the bridge priority of the switch in designated instance.

Description: The bridge priority determines whether the switch can be elected to regional root of spanning tree instance. The smaller value is, the higher priority is. By setting a lower priority, a certain device can be designated to root bridge of spanning tree. The MSTP-enabled device can be configured with different priorities in different spanning tree instance.

Click <Apply> to make current configurations take effect.

4. Configure CIST ports, as shown below.

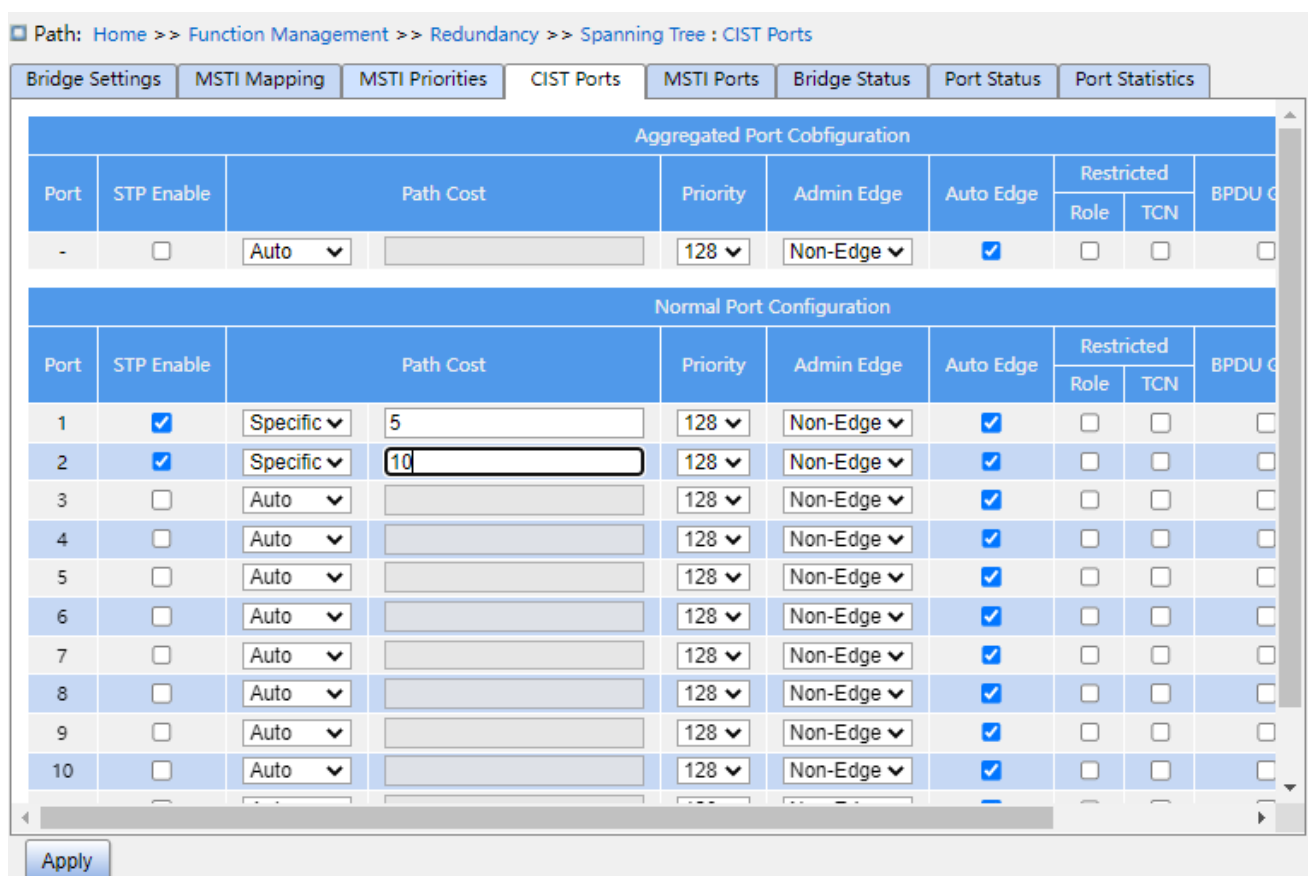

Figure 149 Configure CIST Ports

**STP Enabled**

Configuration options: Enable/Disable

Default configuration: Disable

Function: Enable or disable STP/RSTP on ports.

**Caution:**

MSTP port and port channel are mutually exclusive. A MSTP port cannot be added to a port channel; a port in a port channel cannot be configured as a MSTP port.

**Path Cost**

Configuration options: Auto/Specific (1~200000000)

Default configuration: Auto

Description: The path cost of a port is used to calculate the best path. The value of the parameter depends on the bandwidth. The larger the value, the lower the cost. You can change the role of a port by changing the value of the path cost parameter. To configure the value manually, select No for Cost Count.

**Priority**

Configuration range: 0~240. The step is 16.

Default configuration: 128

Function: Configure the port priority, which determines the roles of ports.

**Admin Edge**

Configuration options: Non-Edge/Edge

Default configuration: Non-Edge

Function: Set whether the current port is an edge port.

Description: When a port is directly connected to a terminal and is not connected to other devices or a shared network segment, the port is considered as an edge port. An edge can rapidly migrate from the blocking state to the forwarding state without waiting delay. After an edge port receives BPDU packets, it becomes a non-edge port.

**Auto Edge**

Configuration options: Enable/Disable

Default configuration: Enable

Function: Whether to enable the automatic detection function of an edge port.

**Restricted Role**

Configuration options: Enable/Disable

Default configuration: Disable

Function: A restricted port will be never selected as a root node even if it is granted the highest priority.

### **Restricted TCN**

Configuration options: Enable/Disable

Default configuration: Disable

Function: A port with restricted TCN will not actively send TCN messages.

### **BPDU Guard**

Configuration options: Enable/Disable

Default configuration: Disable

Function: Control whether an edge port enters the Error-Disable state and is shut down when receiving BPDU packets.

### **Point-to-point**

Configuration options: Auto/Forced True/Forced False

Default configuration: Auto

Function: Set the connection type for a port. If a port is connected to a point-to-point link, the port can rapidly migrate to another state.

Description: Auto indicates that the switch automatically detects the link type based on the duplex status of a port. When a port works in full-duplex mode, the switch considers that the type of the link connected to the port is point-to-point; when a port works in half-duplex mode, the switch considers that the type of the link connected to the port is shared. Forced point-to-point refers that a link connected to a port is a point-to-point link, and forced sharing refers that a link connected to a port is a shared link.

5. Configure MSTI ports, as shown below.



Path: Home >> Function Management >> Redundancy >> Spanning Tree : MSTI Ports

Bridge Settings | MSTI Mapping | MSTI Priorities | CIST Ports | **MSTI Ports** | Bridge Status | Port Status | Port Statistics

MSTI:

Aggregated Port Configuration		
Port	Path Cost	Priority
-	<input type="text" value="Auto"/>	<input type="text" value="128"/>

Normal Port Configuration		
Port	Path Cost	Priority
1	<input type="text" value="Auto"/>	<input type="text" value="128"/>
2	<input type="text" value="Auto"/>	<input type="text" value="128"/>
3	<input type="text" value="Auto"/>	<input type="text" value="128"/>
4	<input type="text" value="Auto"/>	<input type="text" value="128"/>
5	<input type="text" value="Auto"/>	<input type="text" value="128"/>
6	<input type="text" value="Auto"/>	<input type="text" value="128"/>
7	<input type="text" value="Auto"/>	<input type="text" value="128"/>
8	<input type="text" value="Auto"/>	<input type="text" value="128"/>
9	<input type="text" value="Auto"/>	<input type="text" value="128"/>
10	<input type="text" value="Auto"/>	<input type="text" value="128"/>
11	<input type="text" value="Auto"/>	<input type="text" value="128"/>

Figure 150 Select MSTI

**Select MSTI**

Configuration range: MST1~MST7

Default configuration: MST1

Function: Select a MSTI.

**MSTI Aggregated Port Configuration**

Function: Configure the aggregation group as an MSTP port and configure its path cost and priority in the specified instance.

**Path Cost**

Configuration options: Auto/Specific (1~200000000)

Default configuration: Auto

Function: Configure the path cost of the port in the designated instance.

Description: Port path cost is used to calculate the optimum path. This parameter depends on bandwidth. The bigger bandwidth is, the lower cost is. Changing port path costs can change the transmission path between the device and root bridge, thereby changing port

role. The MSTP-enabled port can be configured with different path costs in different spanning tree instances.

**Priority**

Configuration range: 0~240. The step is 16.

Default configuration: 128

Function: Configure the priority of the port in the designated instance.

Description: Port priority determines whether it will be elected to root port. In the same condition, the port with lower priority will be elected to root port. The MSTP-enabled ports can be configured with different priorities and play different port roles in different spanning tree instances.

Click the <Apply> button to make the current configuration take effect.

6. View bridge status, as shown below.

Path: Home >> Function Management >> Redundancy >> Spanning Tree : Bridge Status

Bridge Settings | MSTI Mapping | MSTI Priorities | CIST Ports | MSTI Ports | Bridge Status | Port Status | Port Statistics

Auto Refresh

MSTI	Bridge ID	Root			Topology Flag	Topology Change Last
		ID	Port	Cost		
<a href="#">CIST</a>	32768.00-22-A2-01-02-12	32768.00-22-A2-01-02-12	-	0	Steady	-
<a href="#">MSTI1</a>	32769.00-22-A2-01-02-12	32769.00-22-A2-01-02-12	-	0	Steady	-
<a href="#">MSTI3</a>	32771.00-22-A2-01-02-12	32771.00-22-A2-01-02-12	-	0	Steady	-
<a href="#">MSTI4</a>	32772.00-22-A2-01-02-12	32772.00-22-A2-01-02-12	-	0	Steady	-

Figure 151 View Bridge Status

**MSTI**

Function: Indicates an instance of spanning tree. cist: Indicates the default CIST instance when using the STP/RSTP protocol; MSTI: Indicates an instance of each spanning tree when using MSTP.

**Bridge ID**

Function: Indicates the bridge ID of the current spanning tree instance of this device, consisting of the bridge priority and the bridge MAC address.

**Root**

Function: Indicates the root bridge information in the current spanning tree instance of this device. id: Indicates the bridge ID of the root bridge in the current spanning tree instance. port: Indicates the root port in the current spanning tree instance. Overhead: Indicates the

path overhead from the root port to the root bridge in the current spanning tree instance.

**Topology Flag**

Function: Indicates the current running state of the spanning tree instance.

**Duration after topology change**

Function: Indicates the time interval since the last topology change to the present.

7. View STP ports status, as shown below.

Path: Home >> Function Management >> Redundancy >> Spanning Tree : Port Status

Bridge Settings | MSTI Mapping | MSTI Priorities | CIST Ports | MSTI Ports | Bridge Status | Port Status | Port Statistics

Auto Refresh

Port	CIST Role	CIST State	Uptime
1	Non-STP	Forwarding	-
2	Non-STP	Forwarding	-
3	Non-STP	Forwarding	-
4	Non-STP	Forwarding	-
5	Non-STP	Forwarding	-
6	Non-STP	Forwarding	-
7	Non-STP	Forwarding	-
8	Non-STP	Forwarding	-
9	Non-STP	Forwarding	-
10	Non-STP	Forwarding	-

Figure 152 View STP Ports Status

**Port**

Function: The current device port number.

**CIST Role**

Function: The current role of the port in the STP.

**CIST State**

Function: Indicates the status of the port in STP.

**Uptime**

Function: The running time of this port running STP.

8. View STP ports packets statistics, as shown below.

Path: Home >> Function Management >> Redundancy >> Spanning Tree : Port Statistics

Bridge Settings | MSTI Mapping | MSTI Priorities | CIST Ports | MSTI Ports | Bridge Status | Port Status | Port Statistics

Auto Refresh

Port	Transmitted				Received				Discarded	
	MSTP	RSTP	STP	TCN	MSTP	RSTP	STP	TCN	Unknown	Illegal

Figure 153 View STP Ports Packets Statistics

Function: The number of MSTP/RSTP/STP/TCN messages sent/received on the port.  
 Discard: Number of unknown/illegal STP messages.

**7.5.5.5 Typical Configuration Example**

As shown in Figure 154, Switch A, B, C, and D belong to the same MST region. The VLANs marked in red indicate the VLAN packets can be transmitted through the links. After configurations are completed, VLAN packets can be forwarded along different spanning tree instances. VLAN 10 packets are forwarded along instance 1 and the root bridge of instance 1 is Switch A; VLAN 30 packets are forwarded along instance 3 and the root bridge of instance 3 is Switch B. VLAN 40 packets are forwarded along instance 4 and the root bridge of instance 4 is Switch C. VLAN 20 packets are forwarded along instance 0 and the root bridge of instance 0 is Switch B.

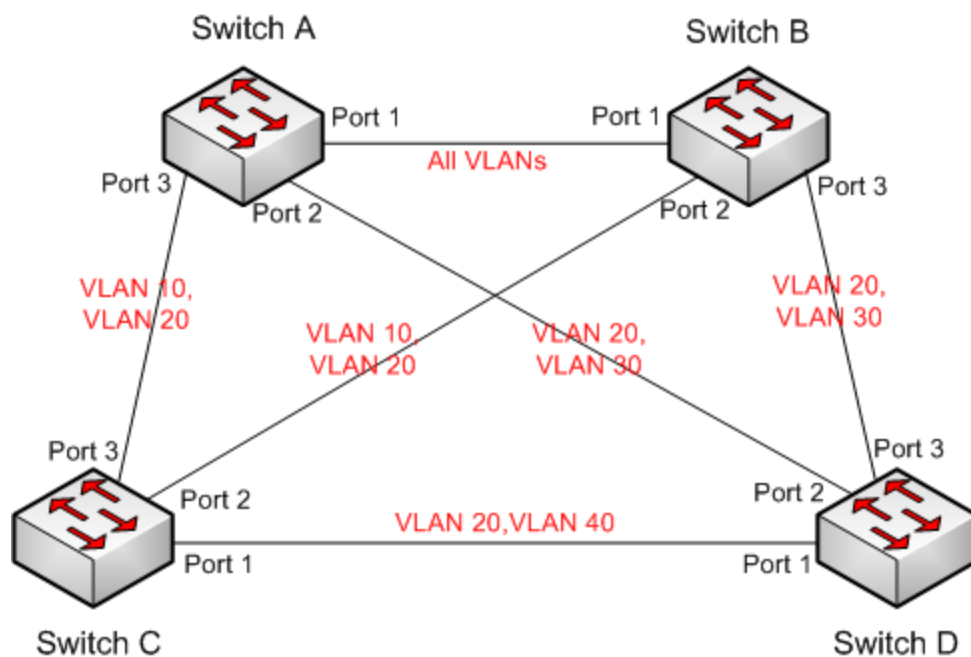

Figure 154 MSTP Typical Configuration Example

**Configuration on Switch A:**

1. Create VLAN 10, 20, and 30 on Switch A; set the ports and allow the packets of corresponding VLANs to pass through.
2. Enable global MSTP protocol, as shown in Figure 146.

3. Set the name of MST region to Region and the revision parameter to 0, as shown in Figure 150.
4. Create MSTI 1, 3, and 4 and map VLAN 10, 30, and 40 to instance 1, 3, and 4 respectively, as shown in Figure 150.
5. Set the switch bridge priority in MSTI 1 to 4096, and keep default priority in other instances, as shown in Figure 148.

**Configuration on Switch B:**

6. Create VLAN 10, 20, and 30 on Switch B; set the ports and allow the packets of corresponding VLANs to pass through.
7. Enable global MSTP protocol, as shown in Figure 146.
8. Set the name of MST region to Region and the revision parameter to 0, as shown in Figure 150.
9. Create MSTI 1, 3, and 4 and map VLAN 10, 30, and 40 to instance 1, 3, and 4 respectively, as shown in Figure 150.
10. Set switch bridge priority in MSTI 3 and MSTI 0 to 4096, and keep default priority in other instances, as shown in Figure 148.

**Configuration on Switch C:**

11. Create VLAN 10, 20, and 40 on Switch C; set the ports and allow the packets of corresponding VLANs to pass through.
12. Enable global MSTP protocol, as shown in Figure 146.
13. Set the name of MST region to Region and the revision parameter to 0, as shown in Figure 150.
14. Create MSTI 1, 3, and 4 and map VLAN 10, 30, and 40 to instance 1, 3, and 4 respectively, as shown in Figure 150.
15. Set switch bridge priority in MSTI 4 to 4096, and keep default priority in other instances, as shown in Figure 148.

**Configuration on Switch D:**

16. Create VLAN 20, 30, and 40 on Switch D; set the ports and allow the packets of corresponding VLANs to pass through.
17. Enable global MSTP protocol, as shown in Figure 146.

18. Set the name of MST region to Region and the revision parameter to 0, as shown in Figure 150.

19. Create MSTI 1, 3, and 4 and map VLAN 10, 30, and 40 to instance 1, 3, and 4 respectively, as shown in Figure 150.

When MSTP calculation is completed, the MSTI of each VLAN is as follows:

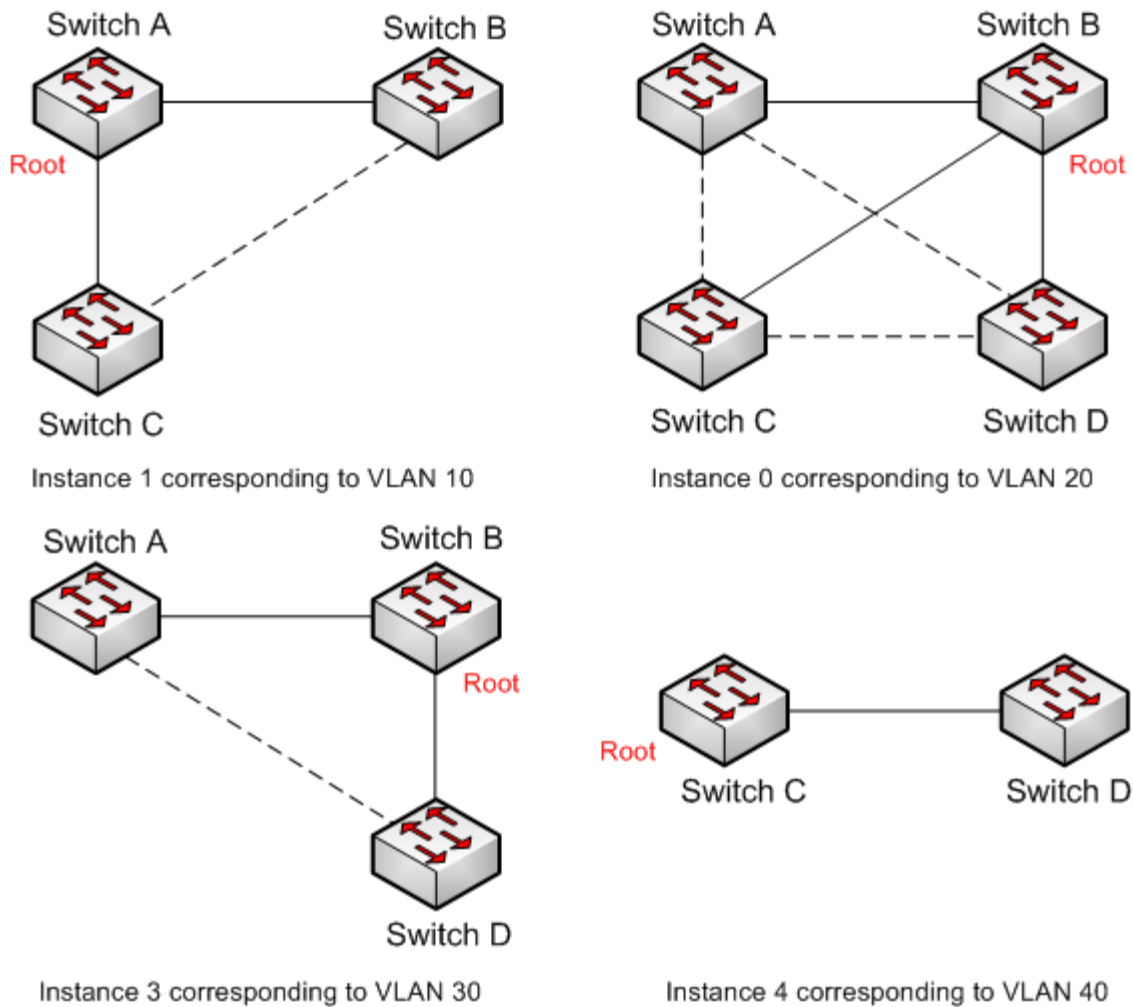

.....Blocked link through MSTP calculation

Figure 155 Spanning Tree Instance of each VLAN

## 7.6 ARP Configuration

### 7.6.1 Introduction

The Address Resolution Protocol (ARP) resolves the mapping between IP addresses and

MAC addresses by the address request and response mechanism. The switch can learn the mapping between IP addresses and MAC addresses of other hosts on the same network segment. It also supports static ARP entries for specifying mapping between IP addresses and MAC addresses. Dynamic ARP entries periodically age out, ensuring consistency between ARP entries and actual applications.

This series switches provide not only Layer 2 switching function, but also the ARP function for resolving the IP addresses of other hosts on the same network segment, enabling the communication between the NMS and managed hosts.

### 7.6.2 Description

The ARP table items is divided into dynamic ARP table items and static ARP table items. Dynamic table items are generated and maintained automatically through ARP message interaction, which can be aged, updated by new ARP messages and overwritten by static ARP table items.

Static table items are manually configured and maintained and are not aged or overwritten by dynamic ARP table items.

### 7.6.3 Proxy ARP

If the ARP request is sent from the host of one network to another host on the same network segment but not on the same physical network, then the gateway with proxy ARP function that directly connected to the source host can reply to the request message, which is called the proxy ARP.

The process of proxy ARP is as follows:

- 1、 The source host sends a ARP request to the host of another physical network;
- 2、 The gateway directly connected to the source host has enabled the proxy ARP function of the VLAN interface. If there is a normal route to the destination host, the destination host will be replaced to replay mac address of its own interface.
- 3、 The IP messages which is sent by the source host to the destination host are sent to the enabled proxy ARP device.
- 4、 Gateway performs normal IP routing forwarding of messages.

5、 IP messages that sent to the destination host reach the destination host through the network.

### 7.6.4 Web Configuration

1. Configure the static ARP address table items, as shown below.

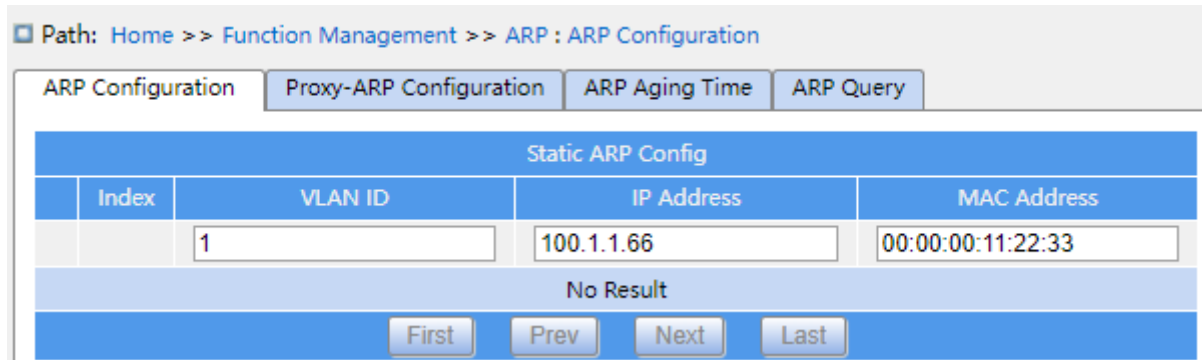

Figure 156 Configure static ARP table items

#### VLAN ID

Configuration content: Created L3 VLAN interface, range 1-4094

Function: select the L3 VLAN interface of the current ARP table item.

#### IP address

Configuration format: A.B.C.D

Function: configure IP addresses for static ARP table items.

#### MAC address

Configuration format: HH-HH-HH-HH-HH-HH (H is a hexadecimal number)

Function: configure the mac address of the static ARP table items.



**Caution:**

In general, the switch automatically learns ARP table items, and no need administrator configure static table items.

2. Proxy ARP Configuration, as shown below.



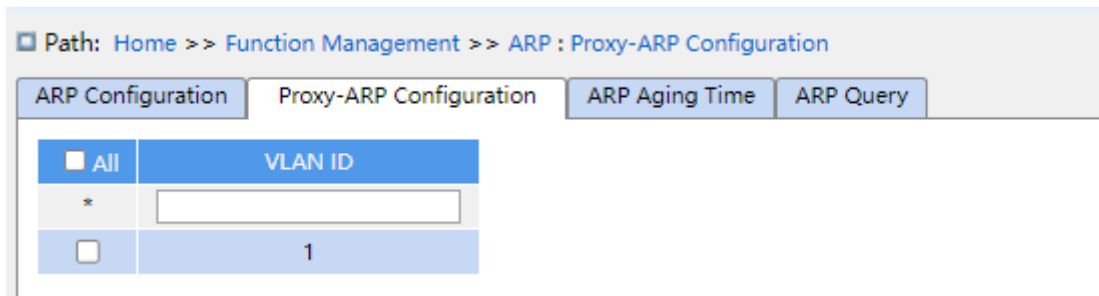

Figure 157 Proxy ARP Configuration

**VLAN ID**

Configuration range: 1-4094

Function: Select L3 interface of enabled proxy ARP.

3. ARP Aging Time Configuration, as shown below.

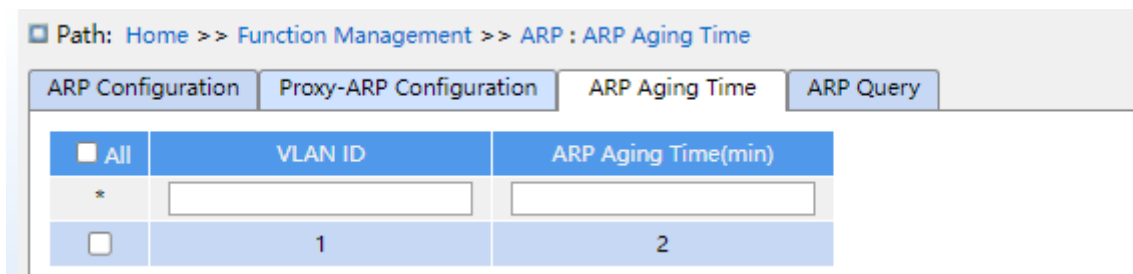

Figure 158 ARP Aging Time Configuration

**VLAN ID**

Configuration range: 1-4094

Function: specify the L3 interface with configuring ARP aging time

**ARP Aging Time**

Configuration range: 1 ~ 60min

Function: configure ARP aging time

Description: ARP aging time refers to start timing by adding a dynamic ARP table item to the address table, and the dynamic address table item will be deleted from the ARP list after the aging time is up.

4. ARP Query, as shown below.

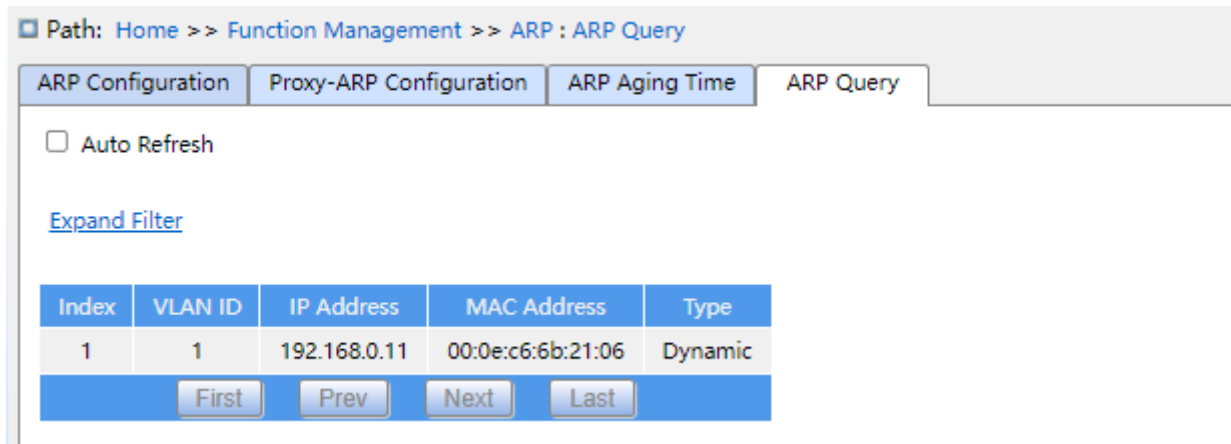

Figure 159 ARP Query

### ARP Query

Display item: {index, VLAN ID, IP address, MAC address, type}

Function: display ARP table item

Description: The list displays all ARP table items corresponding to the linkup status port, includes static and dynamic table items.

## 7.7 ACL Configuration

### 7.7.1 Overview

With the development of network technologies, security issues have become increasingly prominent, calling for access control mechanism. With the Access Control List (ACL) function, the switch matches packets with the list to implement access control.

### 7.7.2 Implementation

The series switches filter packets according to the matched ACL. Each entry consists several conditions in the logical AND relationship. ACL entries are independent of each other.

The switch compares a packet with ACL entries in the ascending order of entry IDs. Once a match is found, the action is taken and no further comparison is conducted, as shown in the following figure.

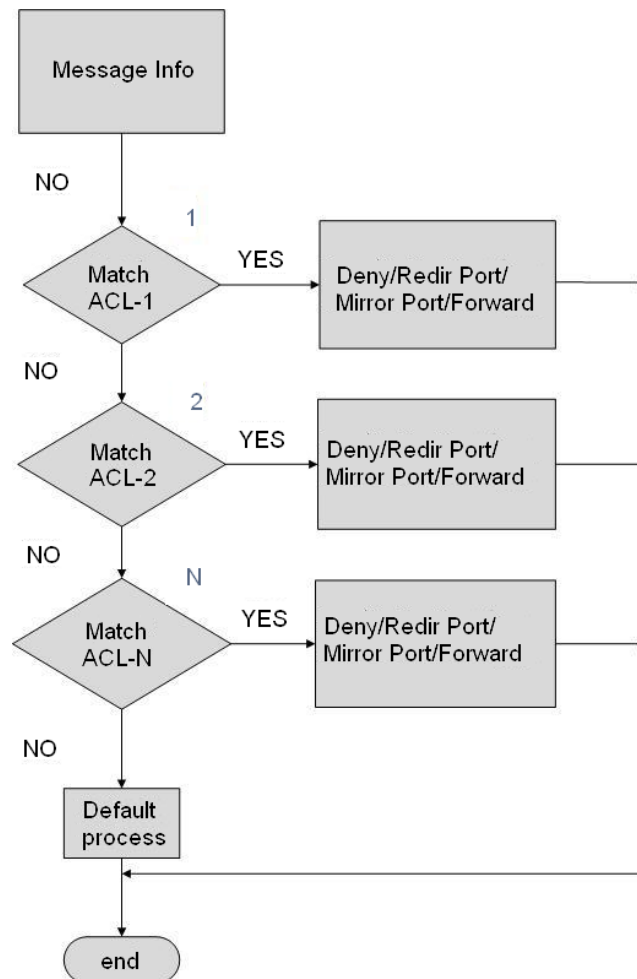

Figure 160 ACL Processing Flowchart



**Note:**

Default process indicates the processing mode towards packets matching no ACL entry.

### 7.7.3 Web Page configuration

#### 1. Configure ACL table entries

Click [Function Management] → [ACL] in the navigation tree → menu to enter the ACL configuration interface, as shown in the following figure:

Path: Home >> Function Management >> ACL

Access Control List

All	ACL ID	Description	Priority	Status	Rule Number	Application Object	
						Global	Port
<input type="checkbox"/>							
<input type="checkbox"/>	1	a	1	Apply	0	--	3_2_1

Figure 161 Configure ACL table entries

**ACL ID**

Configuration range: 1~1024

Function: Configure the ACL table entry ID.

Description: The product supports up to 512 ACL table entries, if the table entries are applied to multiple ports, the application under each port is one ACL table entry.



Caution:

Since some system ACL table entries exist for the device, the number of ACL table entries that can actually be configured by the user is less than 512.

**Description**

Configuration range: 1~127 characters

Function: Add description information to the ACL table entry.

**Priority**

Configuration range: 1-1024

Function: The lower the number, the higher the priority.

2. Click on one of the table entries created in Figure 161 to enter the interface shown in Figure 162 and click on the <Add Rule> button below to configure the ACL table entry rules.

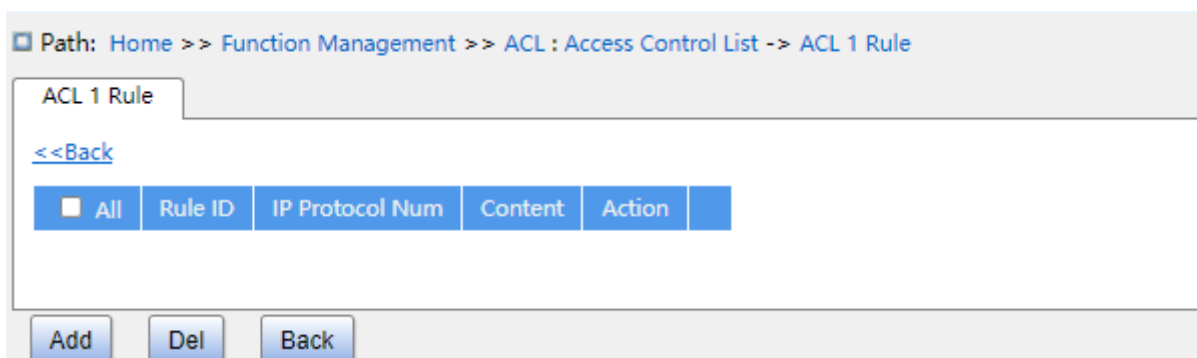

Figure 162 Modify ACL table entry

3. Configure the number of ACL1 table entry rules as shown in the following figure;

Path: Home >> Function Management >> ACL : Access Control List -> ACL 1 Rule -> New Rule

New Rule

[<<Back](#)

ACL ID: 1

Rule ID:

Ethernet Type Value:

IP Protocol:

Destination IP:

Destination IP Mask:

Source IP:

Source IP Mask:

Destination Port:

Source Port:

Destination MAC:

DestinationMAC Mask:

Source MAC:

SourceMAC Mask:

VLAN ID:

Priority:

Action:

Figure 163 ACL rule configuration

**Rule ID**

Configuration range: 1~1024

Function: Configure the rule number of the ACL table entry.

Description: Each ACL table entry supports up to 512 rules, and the total number of rules under all ACLs cannot exceed 512.

**Ethernet Type Value**

Configuration range: 0x600~0xFFFF

Function: Configure the protocol type of the rule.

**IP Protocol**

Configuration options: Any /ICMP/TCP/UDP/Other

Default configuration: Any

Function: Configure the condition parameter - IPv4 message protocol type. When ICMP/UDP/ TCP is selected, the corresponding parameter needs to be configured; when Other is selected, the protocol number needs to be configured. When the protocol type in the IPv4 message received by the incoming port meets the configuration of this parameter, the condition is successfully matched.

#### **Destination IP / Destination IP Mask**

Function: Configure the destination IP address information of the rule. A 1 in the destination IP mask represents a destination IP address bit of interest, and a 0 represents a destination IP address bit to be ignored.

#### **Source IP / Source IP Mask**

Function: Configures the source IP address information of the rule. A 1 in the source IP mask represents a source IP address bit of interest, a 0 represents a source IP address bit to be ignored.

#### **Destination port**

Configuration range: 0~65535

Function: Configure the destination port number of TCP/UDP.

#### **Source Port**

Configuration range: 0~65535

Function: Configure the source port number of TCP/UDP.

#### **Destination MAC / DestinationMAC Mask**

Function: Configure the destination MAC address information of the rule. A 1 in the destination MAC mask represents a destination MAC address bit that is cared for, and a 0 represents a destination MAC address bit that is ignored.

#### **Source MAC / SourceMAC Mask**

Function: Configure the source MAC address information of the rule. A 1 in the source MAC mask represents a source MAC address bit of interest, and a 0 represents a source MAC address bit to be ignored.

#### **VLAN ID**

Configuration options: 1~4093

Function: Configure the VLAN ID of the rule.

**Priority**

Configuration options: 0~7 (COS value)

Function: Configure the re-tagging value of the priority level.

Description: The re-tagging policy will be adopted for the priority value in messages that match the criteria.

**Action**

Configuration options:Permit/Deny/Mirror to CPU/ Mirror to Port/Redirect to CPU/ Redirect to Port/Limit To kbps/Limit To mbps/Limit To pps/Modify DSCP/Modify Queue/Modify VLAN/Modify Cos

Default configuration:Permit

Function: Configure the processing of successfully matched messages.

Description: Permit means to receive a successful match; Deny means to discard a successful match; Mirror to CPU means to receive a successful match and mirror it to the CPU; Mirror to Port means to receive a successful match and mirror it to the specified port; Redirect to CPU means to redirect a successful match to the CPU; Redirect to Port means to redirect the matched messages to the specified port. Limit To kbps means to limit the kbps rate of the matched message; Limit To mbps means to limit the mbps rate of the matched message; Limit To pps means to limit the pps rate of the matched message; Modify DSCP means to modify the DSCP value of the matched message; Modify Queue means to modify the Queue value of the matched message. Modify VLAN means modify the VLAN ID value of the successful message. Modify Cos means modify the CoS value of the successful message.

4. Configure the ACL1 table entry application object, as shown in the following figure.

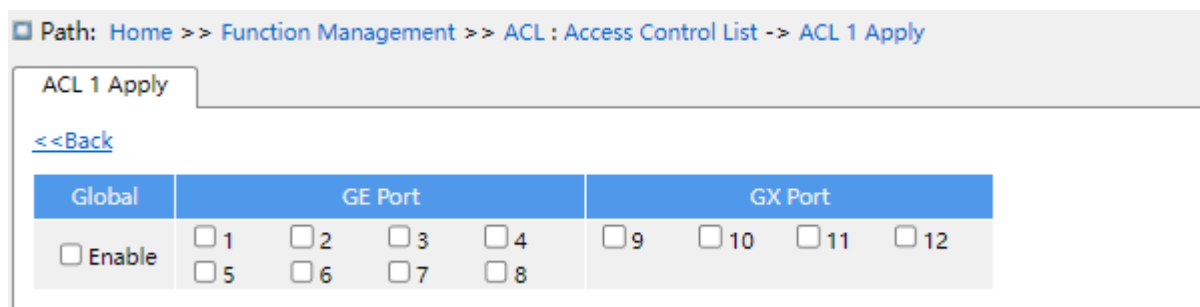

Figure 164 Configure who the ACL is applied to

## ACL1 Application object

Configuration options: Global/FE port/FX port

When applied globally, the ACL rule will take effect on all ports, i.e. global enable will take effect. When applied to a port, the ACL rule will only take effect on the enabled port.

## 7.8 MAC Address Configuration

### 7.8.1 Introduction

When forwarding a packet, the switch searches for the forwarding port in the MAC address table based on the destination MAC address of the packet.

A MAC address can be either static or dynamic.

A static MAC address is configured by a user. It has the highest priority (not overridden by dynamic MAC addresses) and is permanently valid.

Dynamic MAC addresses are learned by the switch in data forwarding. They are valid only for a certain period. The switch periodically updates its MAC address table. When receiving a data frame to be forwarded, the switch learns the source MAC address of the frame, establishes a mapping with the receiving port, and queries the forwarding port in the MAC address table based on the destination MAC address of the frame. If a match is found, the switch forwards the data frame from the corresponding port. If no match is found, the switch broadcasts the frame in its broadcast domain.

Aging time starts from when a dynamic MAC address is added to the MAC address table. If no port receives a frame with the MAC address within one to two times the aging time, the switch deletes the entry of the MAC address from the dynamic forwarding address table.

Static MAC addresses do not involve the concept of aging time.

### 7.8.2 Web Configuration

1. Configure MAC address aging time, as shown below.



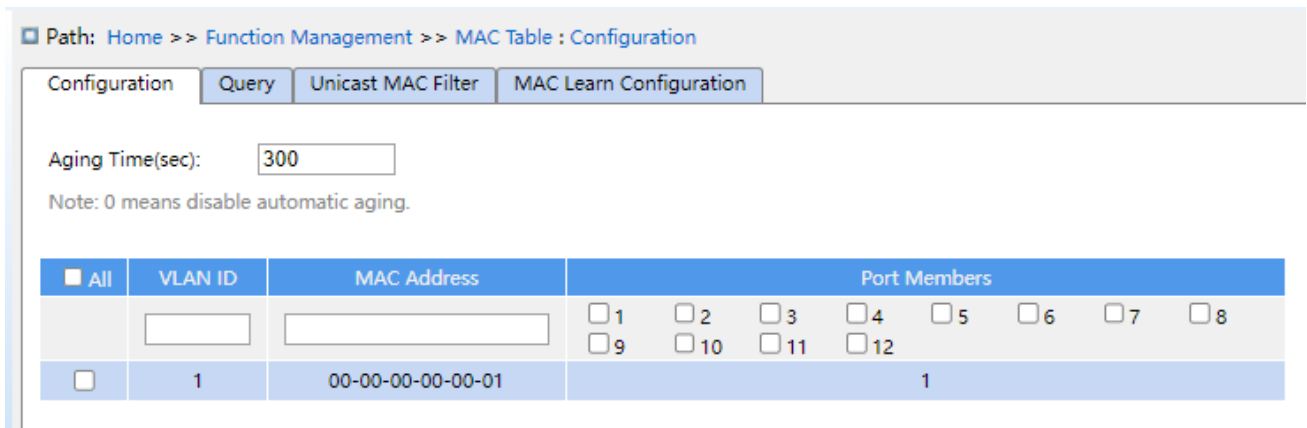

Figure 165 MAC Address Aging Time Configuration

**Aging Time**

Configuration range: 0 or 10~1000000s

Default configuration: 300s

Function: Set the aging time for the dynamic MAC address entry.

**VLAN ID**

Configuration options: all created VLAN IDs

Default configuration: VLAN 1

Function: Configuration the VLAN ID of static MAC address.

**MAC address**

Format: HH-HH-HH-HH-HH-HH (H is a hexadecimal number)

Function: Configure MAC address. For unicast MAC address, the lowest bit in the first byte is 0. For multicast MAC address, the lowest bit in the first byte is 1.

**Port Members**

Function: Select ports to forward the packets with this destination MAC address.

2. View MAC address table, as shown below.

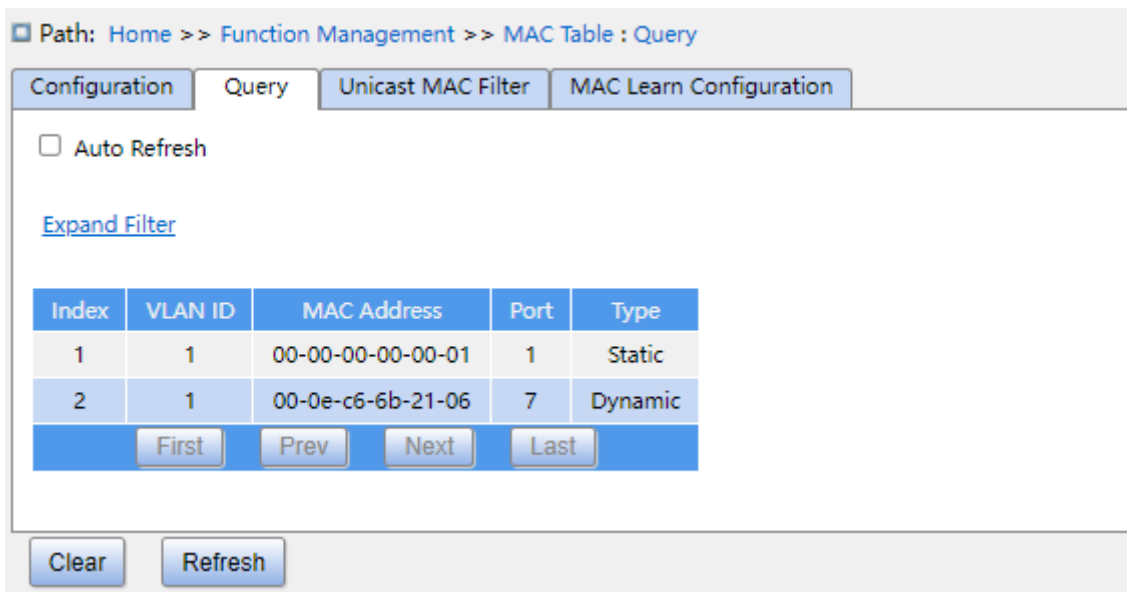

Figure 166 View MAC address table

**VLAN ID**

Configuration options: \*/>=/<=/select range

Default configuration: \*

Function: display the MAC table according to the configured VLAN ID.

**MAC Address**

Configuration options: \*/>=/<=/select range

Default configuration: \*

Function: display the MAC table according to the configured MAC address.

**Port**

Configuration options: \*/include/not include

Default configuration: \*

Function: display the MAC table according to the configured port.

**Type**

Configuration options: \*/static/dynamic

Default configuration: \*

Function: display the MAC table according to the configured type.

3. Configure the unicast MAC filtering table entry as shown in the following figure.

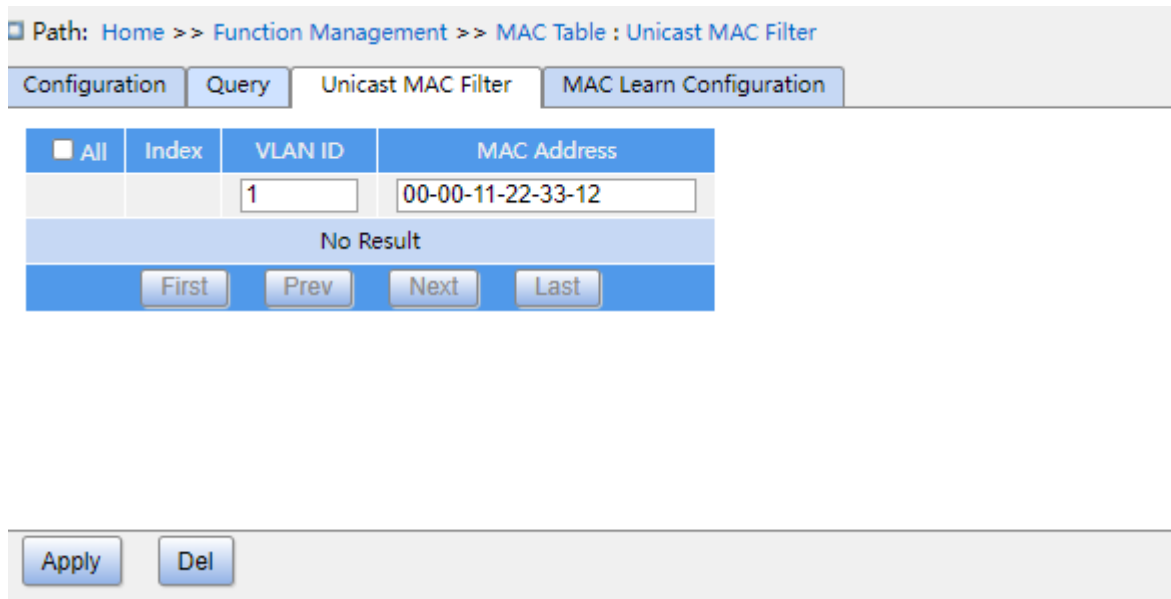

Figure 167 Configure unicast MAC filtering table entries

**VLAN ID**

Configuration options: All VLAN IDs created

Function: Configure the VLAN IDs of the static MAC table.

**MAC Address**

Configuration format: HH-HH-HH-HH-HH-HH or HH:HH:HH:HH:HH:HH (H is a hexadecimal number)

Function: Configures the MAC address. The lowest bit of the highest byte of the unicast MAC address is 0; the lowest bit of the highest byte of the multicast MAC address is 1.

4. MAC learning configuration page, you can configure each port to enable MAC learning, as shown in the following figure.

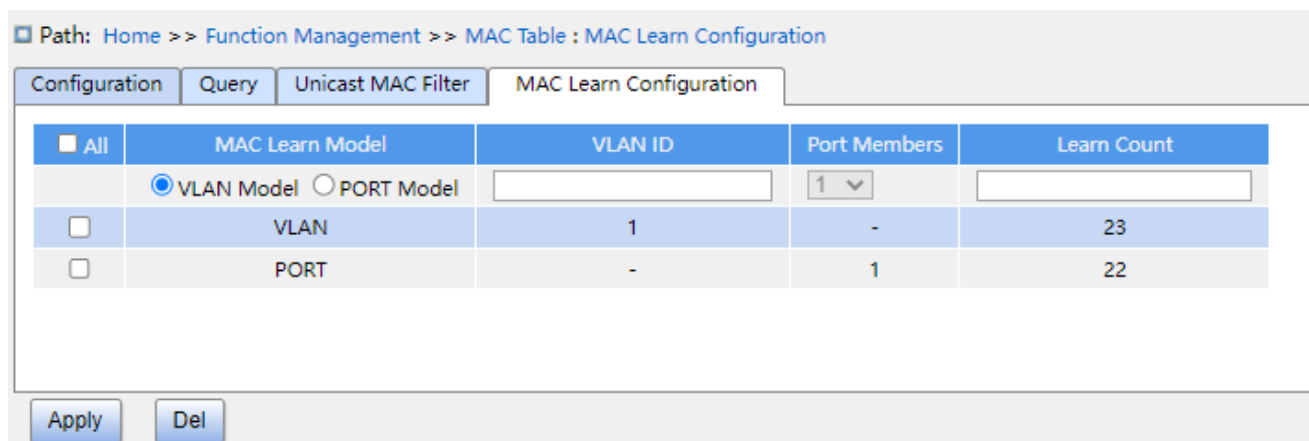

Figure 168 MAC Learning Configuration

### **MAC Learn Model**

Configuration options: VLAN mode / PORT mode

Function: Configure the mode of MAC learning limit, which can limit the number of MAC learning in VLAN or port.

### **VLAN ID**

Configuration options: 1-4093

Function: Configure VLANs that restrict MAC learning .

### **Port Members**

Configuration range: All ports on the device

Function: Enables port MAC learning restriction.

### **Learn Count**

Configuration range: 1~8192

Function: Configure the number of restricted MAC learning.

## **7.9 PoE**

### **7.9.1 Introduce**

POE (Power Over Ethernet) means that the switch can supply power over twisted-pair remotely through Ethernet port, and reliable powered distance is up to 100m. It effectively solve the problem of centralized power supply for IP phone, wireless AP, portable device charger, card brushing machine, camera, data acquisition and so on, without considering the wiring of the indoor power supply system, it can supply the power to the equipment at the same time as it is connected to the network.

The serial switch POE meet IEEE 802.3at standard, it includes PSE and PD, PSE (Power Sourcing Equipment) is the device that supply power to other device, and PD (Powered Device) is the device that powered in the poe power supply system.

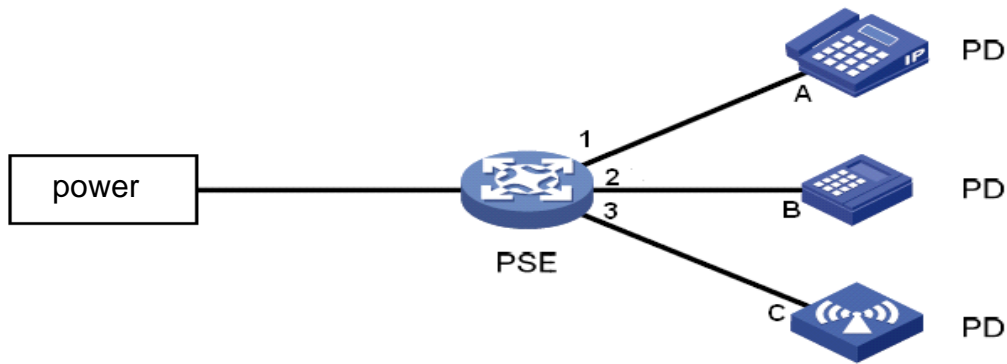

Figure 169 POE power supply system

### 7.9.2 Web Configuration

1. Configure PoE of port, as shown below.

Path: Home >> Function Management >> PoE : Port Configuration

Port Configuration    Status

Port	PoE Mode	Maximum Power [W]
*	<input type="radio"/> Disable <input type="radio"/> PoE <input type="radio"/> PoE+	<input type="text"/>
1	<input type="radio"/> Disable <input checked="" type="radio"/> PoE <input type="radio"/> PoE+	15.4
2	<input type="radio"/> Disable <input checked="" type="radio"/> PoE <input type="radio"/> PoE+	15.4
3	<input checked="" type="radio"/> Disable <input type="radio"/> PoE <input type="radio"/> PoE+	30
4	<input checked="" type="radio"/> Disable <input type="radio"/> PoE <input type="radio"/> PoE+	30
5	<input checked="" type="radio"/> Disable <input type="radio"/> PoE <input type="radio"/> PoE+	30
6	<input checked="" type="radio"/> Disable <input type="radio"/> PoE <input type="radio"/> PoE+	30
7	<input checked="" type="radio"/> Disable <input type="radio"/> PoE <input type="radio"/> PoE+	30
8	<input checked="" type="radio"/> Disable <input type="radio"/> PoE <input type="radio"/> PoE+	30

Apply

Figure 170 Port PoE Configuration

#### PoE Mode

Configuration options: Disable/PoE/PoE+

Default configuration: Disable

Function: Whether enable POE of the port. PoE: the 100M ethernet supports PoE output that meet IEEE802.3af; PoE+: 100M ethernet supports PoE output that meet IEEE802.3at.

#### Maximum Power [W]

Configuration range: 1~15.4w (PoE) /1~30.0w (PoE+)

Function: configure the maximum output power of the PoE port. If the power consumption by the port connected PD device exceeds this configuration value, the PD device can't be powered. According to the actual requirements, the user can reasonably configure the output power limit of each port of the switch, so as to meet the power supply requirement of each port effectively.

2. View PoE Status, as shown below.

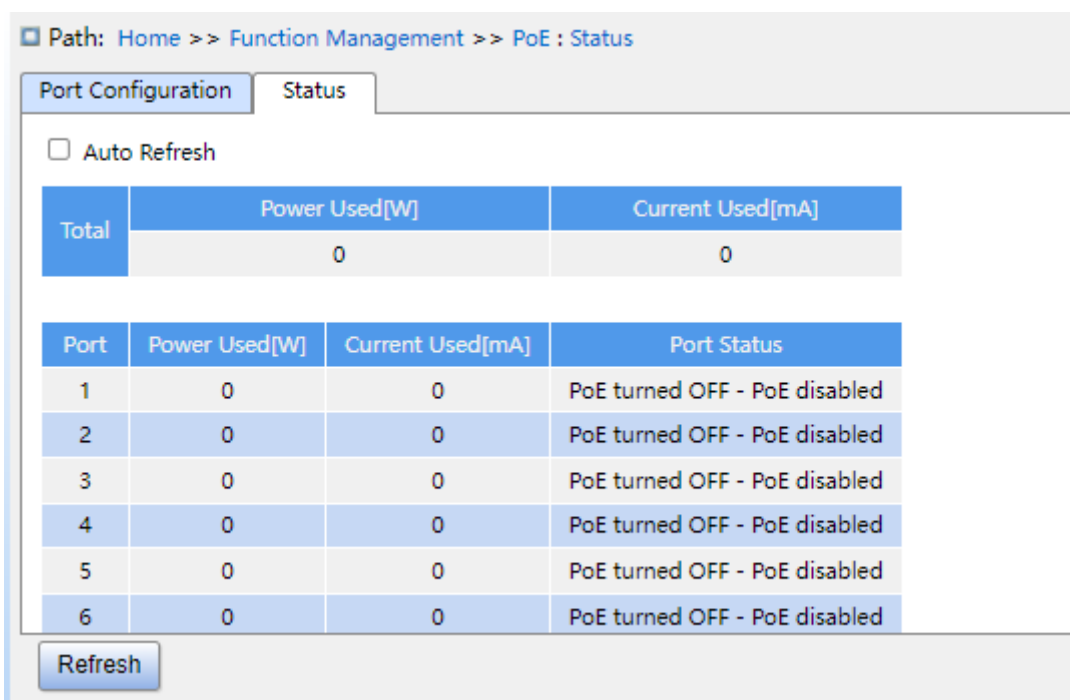

Figure 171 Display PoE Port Status

**Power Used/Current Used**

Function: Displays power consumption, current, and priority parameters for PoE ports.

**Port Status**

Display options: No PD detected/Invalid PD/PoE turned ON/PoE turned OFF-PoE disabled/  
PoE turned OFF-Power budget exceeded/PoE turned OFF-PD overload/

PoE turned ON-PD forced ON

Function: Displays PoE status of port.

Explain: "No PD detected" refers to enable PoE, but do not detect the PD device.

"Invalid PD" refers to enable PoE, detect the PD but power supply is abnormal.

"PoE turned ON" refers to enable PoE, detect the PD device and power supply is normal.

“PoE turned OFF-PoE disabled” refers to disable PoE.

“PoE turned OFF-Power budget exceeded” refers to enable PoE, detect the PD device, but when the access of the PD device causes the total power consumption of all PD devices to exceed the maximum power consumption provided by the whole device, the PD device can't be powered.

“PoE turned OFF-PD overload” refers to enable PoE, detect the PD device, and the total power consumption by all PD devices does not exceed the maximum power consumption provided by the whole device, but the PD device power consumption exceed the maximum output power of the PoE port, the PD device can't be powered.

“PoE turned ON-PD forced ON” refers to enable PoE, and enable forced power.

### 7.9.3 Typical Application Example

As shown in Figure 169, the maximum power provided by the switch as PSE is 11W, the switch port 1 and 2 are connected to device A and B, the maximum power consumption of A is 5W, the maximum power consumption of B is 4W, and the switch port 3 is expected to connect to the device C, and the maximum power consumption of C is 5w.

#### Requirement:

1. The switch is connected only to device A and B, it can supply power normally;
2. If the PD device C is connected to port 3 of the switch, the total power consumption by all PD devices is greater than the maximum power that the switch can provide, need to ensure power to device C which is connected with port 3 of switch first.

#### PSE Configuration as following:

1. Configure Port 1 to PoE mode, as showin in Figure 170.
2. Enable the PoE function of port 1~3,, the other configuration as default.

## 7.10 IGMP Snooping

### 7.10.1 Introduction

Internet Group Management Protocol Snooping (IGMP Snooping) is a multicast protocol at the data link layer. It is used for managing and controlling multicast groups. IGMP

Snooping-enabled switches analyze received IGMP packets, establish mapping between ports and MAC multicast addresses, and forward multicast packets according to the mapping.

There are three versions of the Internet Group Message Protocol (IGMP): IGMPv1, IGMPv2, and IGMPv3. IGMPv1 is defined in RFC1112, IGMPv2 is defined RFC2236, and IGMPv3 is defined in RFC3376.

IGMPv1 supports two types of packets (report and query packets) and defines the basic group member query and report process.

IGMPv2, on the basis of IGMPv1, provides the leave packet of the fast leave mechanism for group members. With this mechanism, when the last member leaves a multicast group, the router is instructed to conduct fast convergence. In comparison with IGMPv1, IGMPv2 supports two types of query packets: general query packet and group-specific query packet. The switch periodically sends a general query packet to query the membership. When a host leaves a multicast group, after the switch receives a leave message, the switch sends a group-specific query packet to determine whether all members leave the multicast group.

The host source filtering function is added to IGMPv3. This function enables a host to specify whether to receive or reject packets from some specific multicast group sources.

### 7.10.2 Basic Concepts

**Querier:** periodically sends IGMP general query packets to query the status of the members in the multicast group, maintaining the multicast group information. When multiple queriers exist on a network, they automatically elect the one with the smallest IP address to be the querier. Only the elected querier periodically sends IGMP general query packets. The other queriers only receive and forward IGMP query packets.

**Router port:** receives general query packets (on an IGMP-enabled switch) from the querier. Upon receiving an IGMP report, a switch establishes a multicast entry and adds the port that receives the IGMP report to the member port list. If a router port exists, it is also added to the member port list. Then the switch forwards the IGMP report to other devices through the router port, so that the other devices establish the same multicast entry.

**IGMP snooping proxy:** The IGMP snooping proxy function is configured on an edge device



to reduce the number of IGMP report packets and leave packets received by an upstream device, thereby improving the overall performance of the upstream device. A device on which the IGMP snooping proxy function is configured functions as a host of its upstream device, and functions as a querier of its downstream host.

### 7.10.3 Principle

IGMP Snooping manages and maintains multicast group members by exchanging related packets among IGMP-enabled devices. The related packets are as follows:

General query packet: The querier periodically sends general query packets (destination IP address: 224.0.0.1) to confirm whether the multicast group has member ports. After receiving the query packet, a non-querier device forwards the packet to all its connected ports.

Specific query packet: If a device wants to leave a multicast group, it sends an IGMP leave packet. After receiving the leave packet, the querier sends a specific query packet (destination IP address: IP address of the multicast group) to confirm whether the group contains other member ports.

Membership report packet: If a device wants to receive the data of a multicast group, the device sends an IGMP report packet (destination IP address: IP address of the multicast group) immediately to respond to the IGMP query packet of the group.

Leave packet: If a device wants to leave a multicast group, the device will send an IGMP leave packet (destination IP address: 224.0.0.2).

### 7.10.4 Web Configuration

1. Enable IGMP Snooping, as shown below.

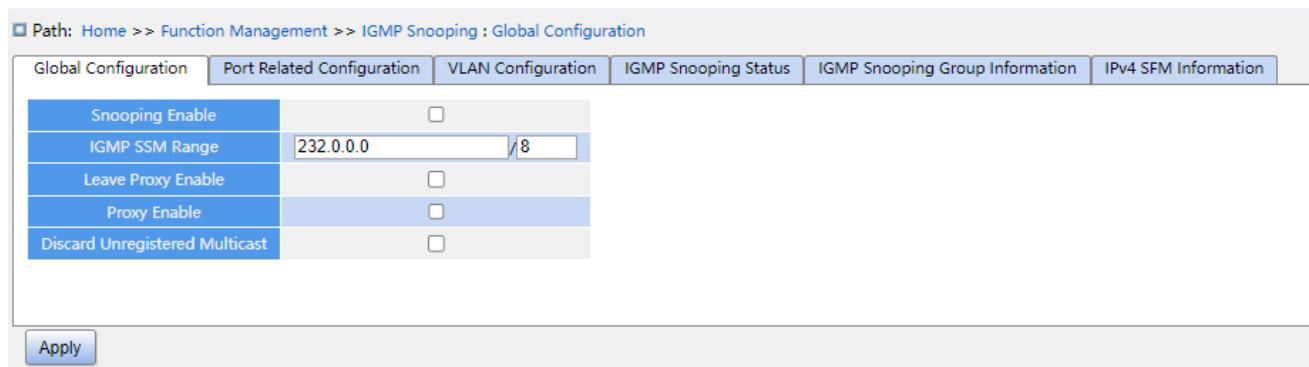

Figure 172 Configure IGMP Snooping

**Snooping Enable**

Configuration options: Enable/Disable

Default configuration: Disable

Function: Enable or disable the global IGMP Snooping protocol.

**IGMP SSM Range**

Configuration Format: A.B.C.D/ 4~32

Default configuration: 232.0.0.0/8

Function: Only hosts and routers with the address within the value of this parameter can run the service model of IGMP source specific multicast (SSM) provided that the hosts and routers support the IGMP SSM service model. The SSM service model provides users with a transmission service of specifying multicast sources for a client.

**Leave Proxy Enable**

Configuration options: Enabled/Disabled

Default configuration: Disabled

Function: Specify whether to forward leave packets to the querier. When it is enabled, leave packets are not forwarded.

**Proxy Enable**

Configuration options: Enabled/Disabled

Default configuration: Disabled

Function: Specify whether to forward leave packets and member report packets to the querier. When it is enabled, leave packets and member report packets are not forwarded.

**Discard Unregistered Multicast**

Configuration options: Enabled/Disabled

Default configuration: Disabled

Function: Whether the switch discards when it receives unknown multicast packets.

2. Configure IGMP port, as shown below.

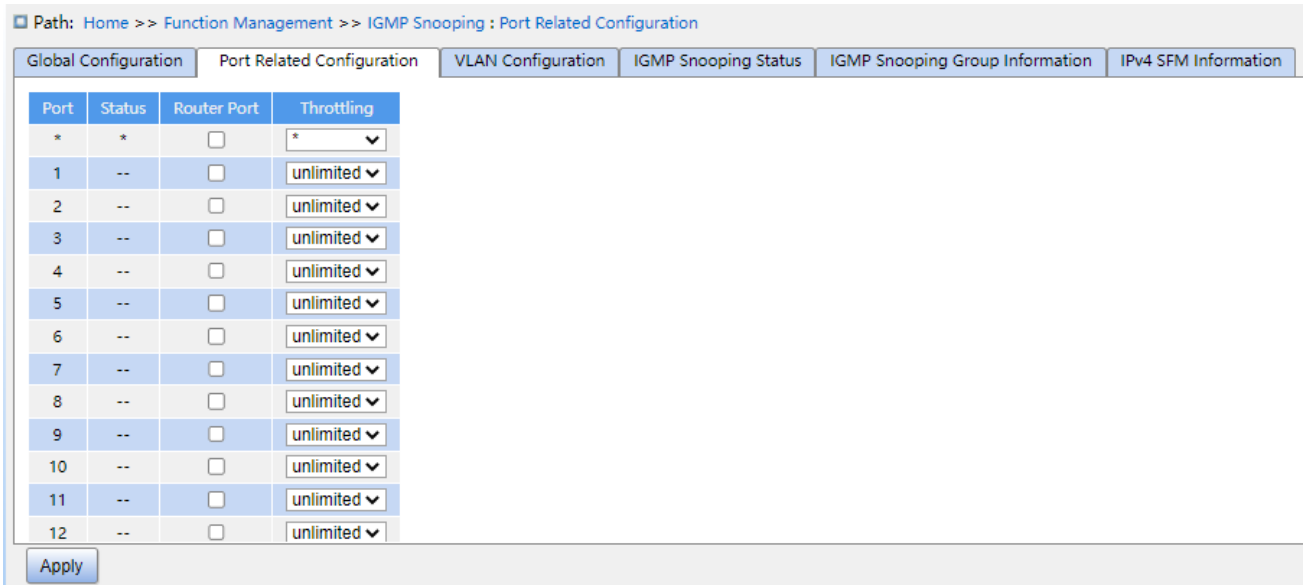

Figure 173 Configure IGMP Port

### Status

Configuration options: --/static/dynamic/both

Function: Displays the router port status. **static** indicates that the port is statically configured as a routed port; **dynamic** indicates that the port is dynamically learned as a routed port. **Both** indicates that the port is dynamically configured as a routing port and dynamically learns to route the port.

### Router Port

Configuration options: Enabled/Disabled

Default configuration: Disabled

Function: Configure router port.

### Throttling

Configuration options: unlimited/1~10

Default configuration: unlimited

Function: Whether to limit the number of multicast entries learnt by a port.

3. Configure IGMP Snooping VLAN, as shown below.



Figure 174 Configure IGMP Snooping VLAN

**VLAN Interface**

Configuration options: all created VLAN IDs

**Snooping Enabled**

Configuration options: Enable/Disable

Default configuration: Disable

Function: Enable or disable the VLAN IGMP Snooping function. The precondition of this function is to enable global IGMP Snooping function.

**Querier Election**

Configuration options: Enable/Disable

Default configuration: Disable

Function: Enable or disable the IGMP query function for the selected VLAN. The precondition of this function is to enable global IGMP Snooping function and the VLAN IGMP Snooping function.

Description: If there are multiple queriers in network, they will automatically select the one with the smallest IP address to be the querier. If there is only one device which enables IGMP query function, it will be the querier.

**Querier Address**

Configuration Format: A.B.C.D

Function: Configure the source IP address of sending the query packet. When set as 0.0.0.0, the IP address of the VLAN port is used as the querier address.

**Compatibility**

Configuration options: Forced IGMPv1/Forced IGMPv2/Forced IGMPv3

Default configuration: Forced IGMPv2

Function: Configure IGMP version.

**PRI (Priority of Interface)**

Configuration range: 0~7

Default configuration: 0

Function: Configure the priority of IGMP control packet.

**RV (Robustness Variable)**

Configuration range: 1~255

Default configuration: 2

Function: Specify the robustness parameter of the IGMP query function.

Description: The larger the parameter, the worse the network environment. User can set a suitable robustness parameter according to the actual network.

**QI (Query Interval)**

Configuration range: 1~31744s

Default configuration: 125s

Function: Configure the interval of sending general query packet.

**QRI (Query Response Interval)**

Configuration range: 0~255 (unit: 0.1s)

Default configuration: 100

Function: Configure the max response time of responding general query packet.

**LLQI (Last Member Query Interval)**

Configuration range: 0~31744 (unit: 0.1s)

Default configuration: 10

Function: Configure the max response time of responding specific query packet.

**Caution:**

QI, QRI, and LLQI configuration is valid only for querier.

---

**URI (Unsolicited Report Interval)**

Configuration range: 0~31744s

Default configuration: 1s

Function: Set the interval for a host to re-send a report packet for joining a multicast group

Click <Add New IGMP VLAN> to configure IGMP Snooping VLAN entry. A maximum of 32 IGMP Snooping VLAN entries are supported.

4. View IGMP Snooping status, as shown below.

Path: Home >> Function Management >> IGMP Snooping : IGMP Snooping Status

Global Configuration | Port Related Configuration | VLAN Configuration | **IGMP Snooping Status** | IGMP Snooping Group Information | IPv4 SFM Information

Auto Refresh

VLAN ID	Querier Version	Host Version	Querier Status	Queries Transmitted	Auenes Received	V1 Reports Received	V2 Reports Received	V3 Reports Received	V2 Leaves Received
1	v3	v3	ACTIVE	1	0	0	0	1	0

Figure 175 View IGMP Snooping Status

Function: This page shows the details of IGMP Snooping under Interface VLAN.

VLAN ID: The Interface VLAN on which IGMP Snooping is enabled.

Query version: The query version of IGMP Snooping under the Interface VLAN, i.e. the version of IGMP messages sent.

Host version: The host version of IGMP Snooping under the Interface VLAN, i.e. the version that receives IGMP messages.

Query status: whether query is enabled under the Interface VLAN.

Query sent/received: the number of query messages sent or received under the Interface VLAN.

Report Received v1/v2/v3: The number of IGMP report messages of v1/v2/v3 version received under Interface VLAN.

V2 Leave Receive: Number of IGMP leave messages received under the nterface VLAN for version V2.

5. View the multicast member list, as shown below.

Path: Home >> Function Management >> IGMP Snooping : IGMP Snooping Group Information

Global Configuration | Port Related Configuration | VLAN Configuration | **IGMP Snooping Status** | **IGMP Snooping Group Information** | IPv4 SFM Information

Auto Refresh

[Expand Filter](#)

Index	VLAN ID	Group	Port Members
1	1	239.255.255.250	5

Figure 176 IGMP Snooping Member List

**VLAN ID**

Configuration options: \*/>=/<<=/selection range

Default configuration: \*

Function: Display the group information according to configured VLAN ID.

**Group**

Configuration options: \*/>=/<<=/selection range

Default configuration: \*

Function: Display the group information according to configured group address.

**Port**

Configuration options: \*/include/not include

Default configuration: \*

Function: Display the group information according to configured port.

6. View the IPv4 SMF information, as shown below.

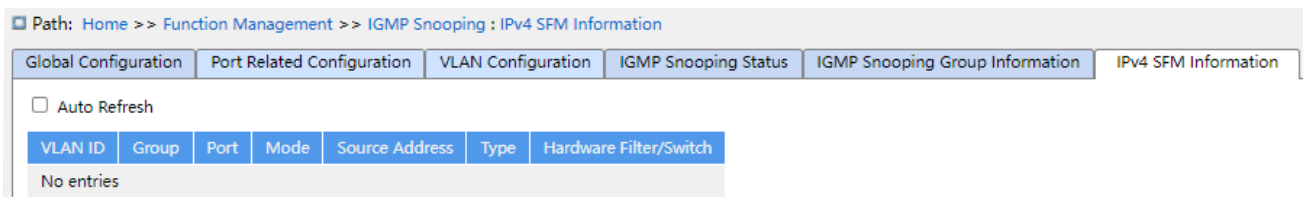

Figure 177 IGMP Snooping IPv4 SFM information

Function: When the device is using the v3 protocol, hosts are able to explicitly request to receive or not receive multicast data from a specific multicast source while joining a multicast group, and this information is included when viewing the multicast membership list on this page.

**7.10.5 Typical Application Example**

As shown in Figure 178, enable IGMP Snooping function in Switch 1, Switch 2, and Switch 3. Enable auto query on Switch 2 and Switch 3. The IP address of Switch 2 is 192.168.1.2 and that of Switch 3 is 192.168.0.2, so Switch 3 is elected to querier.

1. Enable IGMP Snooping.
2. Enable IGMP Snooping and auto-query.
3. Enable IGMP Snooping and auto-query.

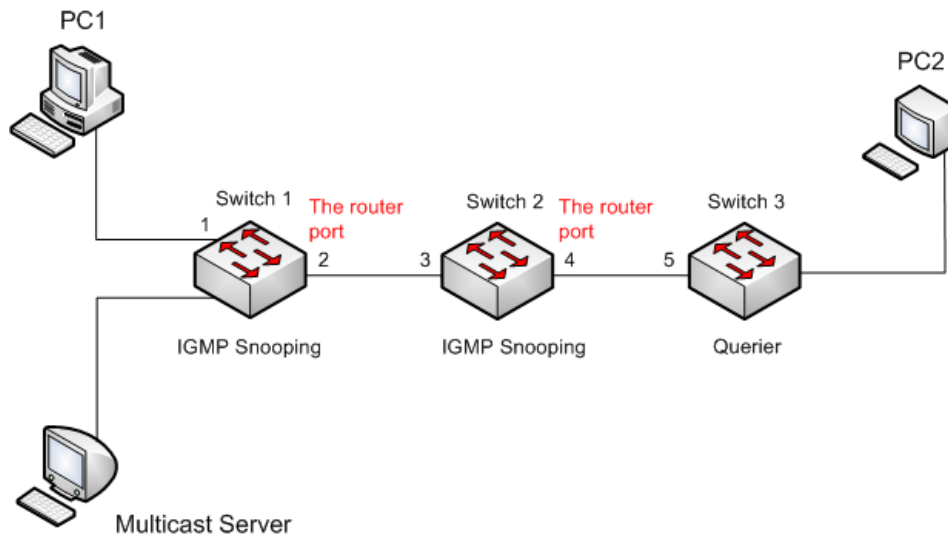

Figure 178 IGMP Snooping Application Example

- Because Switch 3 is elected as the querier, it periodically sends out a general query message.
- Port 4 of Switch 2 receives query message. It becomes router port. Meanwhile, Switch 2 forwards query message from port 3. Then port 2 of Switch 1 is elected to router port once it receives query message from Switch 2.
- When PC 1 joins in multicast group 225.1.1.1, it will send out IGMP report message, so port 1 and router port 2 of Switch 1 will also join in multicast group 225.1.1.1. Then, the IGMP report message will be forwarded to Switch 2 by router port 2, so port 3 and port 4 of Switch 2 will also join in 225.1.1.1, and then the IGMP report message will be forwarded to Switch 3 by router port 4, so port 5 of Switch 3 will join in 225.1.1.1 as well.
- When multicast server's multicast data reaches Switch 1, the data will be forwarded to PC1 by port 1; because router port 2 is also a multicast group member, so the multicast data will be forwarded by router port. In this way, when the data reaches port 5 of Switch 3, it will stop forwarding because there is no receiver any more, but if PC2 also joins in group 255.1.1.1, the multicast data will be forwarded to PC2.

## 7.11 DHCP Configuration

With the continuous expansion of network scale and the growing of network complexity, under the conditions of the frequent movement of computers (such as laptops or wireless network) and the computers outnumbering the allocable IP addresses, the BootP protocol



that is specially for the static host configuration has become increasingly unable to meet actual needs. For fast access and exit network and improving the utilization ratio of IP address resources, we do need to develop an automatic mechanism based on BootP to assign IP addresses. DHCP (Dynamic Host Configuration Protocol) was introduced to solve these problems.

DHCP employs a client-server communication model. The client sends a configuration request to the server, and then the server replies configuration parameters such as an IP address to the client, achieving the dynamic configuration of IP addresses. The structure of a DHCP typical application is shown in Figure 179.

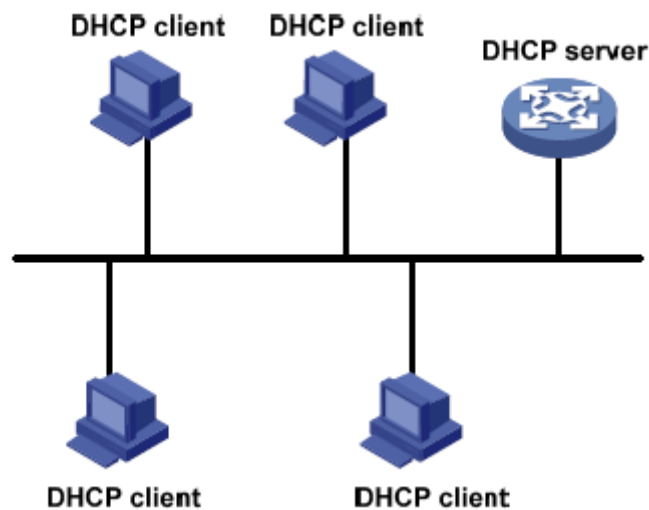

Figure 179 DHCP Typical Application



**Caution:**

In the process of dynamic obtainment of IP addresses, the messages are transmitted in the way of broadcast, so it is required that the DHCP client and the DHCP server are in a same segment. If they are in the different segments, the client can communicate with the server via a DHCP relay to get IP addresses and other configuration parameters.

DHCP supports two types of IP address allocation mechanisms.

Static allocation: the network administrator statically binds fixed IP addresses to few specific clients such as a WWW server and sends the binding IP addresses to clients by DHCP. The tenancy term for static allocation is permanent.

Dynamic allocation: DHCP server dynamically allocates an IP address to a client. This

allocation mechanism can allocate a permanent IP address or an IP address with a limited lease period to a client. When the lease expires, the client needs to reapply an IP address. The network administrator can choose a DHCP allocation mechanism for each client.

## 7.11.1 DHCP Server Configuration

### 7.11.1.1 Introduction

DHCP server is a provider of DHCP services. It uses DHCP messages to communicate with DHCP client to allocate a suitable IP address to the client and assign other network parameters to the client as required. In the following conditions, the DHCP server generally is used to allocate IP addresses.

- Large network scale. The workload of manual configuration is heavy and it is hard to manage the entire network.
- The hosts outnumber the assignable IP addresses, and it is unable to allocate a fixed IP address to each host.

Only a few hosts in the network need fixed IP addresses.

### 7.11.1.2 DHCP Address Pool

The DHCP server selects an IP address from an address pool and allocates it together with other parameters to the client. The IP address allocation sequence is as follows:

1. The IP address statically bound to the client MAC address.
2. The IP address that is recorded in the DHCP server that it was ever allocated to the client.
3. The IP address that is specified in the request message sent from the client.
4. The first allocable IP address found in an address pool.
5. If there is no available IP address, check the IP address whose lease expires and that had conflicts in order. If found, allocate the IP address. If not, no process.

### 7.11.1.3 Web Configuration

1. Enable DHCP server, as shown below.

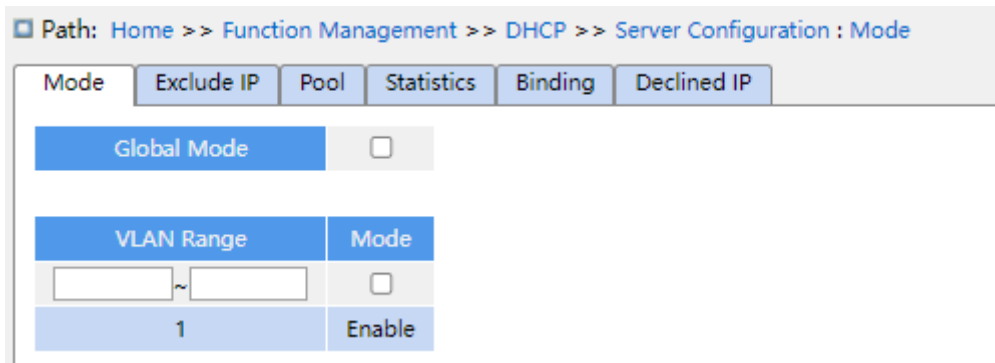

Figure 180 Enable DHCP Server

**Global Mode**

Configuration options: Disabled/Enabled

Default configuration: Disabled

Function: Select the current switch to the DHCP server to allocate an IP address to a client or not.

**{VLAN Range, Mode}**

Configuration range: {1~4093, Disabled/Enabled}

Function: If the VLAN of a client that applies for an IP address is set to Enabled, the DHCP server allocates an IP address to the client. Otherwise, the DHCP server does not allocate an IP address to the client.

2. Create DHCP address pool, as shown below.

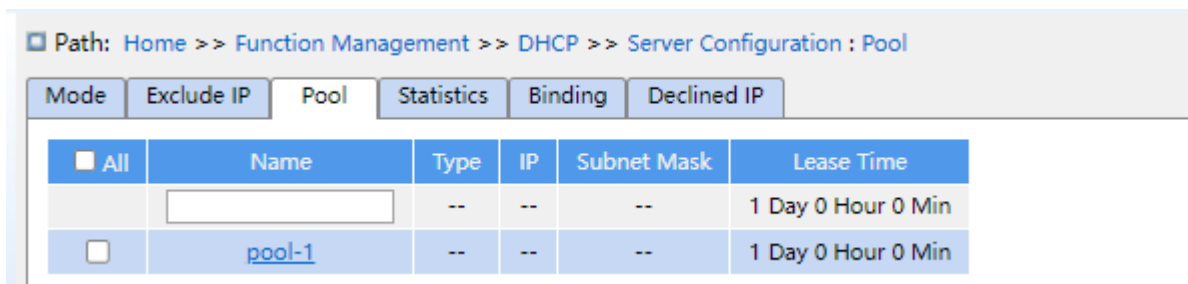

Figure 181 Create DHCP Address Pool

**Name**

Configuration range: 1~32 characters

Function: configure the name of the IP address pool.

Click <Apply> to create a new DHCP address pool.

3. Configure the DHCP address pool, click <Name> in Figure 181 to configure the DHCP address pool, as shown below.

Path: Home >> Function Management >> DHCP >> Server Configuration : Pool -> Detail Configuration[pool-1]

Mode Exclude IP Detail Configuration[pool-1] Statistics Binding Declined IP

<<Back

Pool Name	pool-1	
Type	Host <input type="button" value="v"/>	
IP	192.168.0.23	
Subnet Mask	255.255.255.0	
Lease Time	1	Day(0-365)
	0	Hour(0-23)
	0	Min(0-59)
Domain Name	domain.com	
Broadcast Address		
Default Router	192.168.0.201	
DNS Server	192.168.0.202	
NTP Server	192.168.0.203	
NetBIOS Node Type	None <input type="button" value="v"/>	
NetBIOS Scope		
NetBIOS Name Server		
NIS Domain Name		
NIS Server		
Client Identifier	MAC <input type="button" value="v"/>	
	00-11-22-33-44-55	
Hardware Address	00-11-22-33-44-55	
Client Name		
Vendor 1 Class Identifier		
Vendor 1 Specific Information		
Vendor 2 Class Identifier		
Vendor 2 Specific Information		
Vendor 3 Class Identifier		
Vendor 3 Specific Information		
Vendor 4 Class Identifier		
Vendor 4 Specific Information		

Apply Back

Figure 182 Configure IP Address Pool

**Type**

Configuration options: None/Network/Host

Default configuration: None

Function: Configure the address pool type. Network: the switch dynamically allocates IP addresses to multiple DHCP clients. Host: the switch supports static allocation of IP addresses to special DHCP clients.

**{IP, Subnet Mask}**

Function: Network indicates that you can configure the range of the IP address pool, and the address range is determined by the subnet mask. The subnet mask is a number with a length of 32 bits and consists of a string of 1 and a string of 0. "1" corresponds to network number fields and subnet number fields, while "0" corresponds to host number fields. It is generally configured to 255.255.255.0.

Host indicates that you can configure the IP address of the client statically bounded. Static IP address allocation is implemented by bounding the MAC address and IP address of the client. When the client with this MAC address requests for IP address, the DHCP server finds the IP address corresponding to the MAC address of the client and allocates the IP address to the client. The priority of this allocation mode is higher than that of dynamic IP address allocation, and the tenancy term is permanent.

**Lease Time**

Configuration range: 0 day 0 hour 0 minute~365 days 23 hours 59 minutes

Default configuration: 1 day 0 hour 0 minute

Description: Configure lease timeout of dynamic allocation. For different address pools, DHCP server can set different address lease time, but the addresses in the same DHCP address pool have the same lease time.

**Domain Name**

Configuration range: 1~36 characters

Configuration Function: Configure the domain name of the IP address pool. When allocating an IP address to a client, send the domain name suffix to the client too.

**Broadcast Address**

Format: A.B.C.D

Function: Configure the client broadcast address allocated by DHCP server.

### **Default Router**

Format: A.B.C.D

Function: Configure the client gateway address allocated by DHCP server.

Explanation: when the DHCP client visits the host that is in the different segment, the data must be forwarded via gateways. When the DHCP server allocates IP addresses to clients, it can specify gateway addresses at the same time. DHCP address pool can configure max 4 gateways.

### **DNS Server**

Format: A.B.C.D

Function: Configure the client DNS server address allocated by DHCP server.

Explanation: When visiting the network host via a domain name, the domain name needs to be resolved to an IP address, which is realized by DNS (Domain Name System). In order to let a DHCP client visit a network host via a domain name, when the DHCP server allocates IP addresses to clients, it can specify IP addresses of domain name servers at the same time. DHCP address pool can configure max 4 DNS servers.

### **NTP Server**

Format: A.B.C.D

Function: Configure the client NTP server address allocated by DHCP server.

### **NetBIOS Node Type**

Configuration options: None/B-node/P-node/M-node/H-node

Default configuration: None

Function: Configure the client NetBIOS node type allocated by DHCP server. When the DHCP client uses the NetBIOS protocol for communication on the network, a mapping must be established between the host name and IP address. Different node types obtain the mapping in different modes.

Description: The B-node obtains the mapping in broadcast mode. The P-node obtains the mapping by sending a unicast packet to communicate with the WINS server. The M-node obtains the mapping by sending a broadcast packet the first time. If the M-node fails to

obtain the mapping the first time, it obtains the mapping by sending a unicast packet to communicate with the WINS server the second time. The H-node obtains the mapping by sending a unicast packet to communicate with the WINS server the first time. If the H-node fails to obtain the mapping the first time, it obtains the mapping by sending a broadcast packet the second time.

### **NetBIOS Scope**

Configuration range: 1~36 characters

Function: Configure the NetBIOS name.

### **NetBIOS Name Server**

Format: A.B.C.D

Function: Configure the client WINS server address allocated by the DHCP server.

Explanation: For the client running a Microsoft Windows operating system (OS), the Windows Internet Naming Service (WINS) server provides the service of resolving a host name into an IP address for the host that uses the NetBIOS protocol for communication. Therefore, most Windows OS-based clients require WINS configuration. To enable the DHCP client to resolve a host name into an IP address, specify the WINS server address when the DHCP server allocates an IP address to the client. DHCP address pool can configure max 4 WINS servers.

### **NIS Domain Name**

Configuration range: 1~36 characters

Function: Configure the client NIS domain name allocated by DHCP server.

### **NIS Server**

Format: A.B.C.D

Function: Configure the client NIS server address allocated by DHCP server.

### **Client Identifier**

Configuration options: None/FQDN/MAC

Default configuration: None

Function: When the pool type is host, specify client's unique identifier

### **Hardware Address**

Format: HH-HH-HH-HH-HH-HH (H is a hexadecimal number)

Function: When the pool type is host, configure the MAC address of the client statically bounded.

**Client Name**

Configuration range: 1~32 characters

Function: Configure client user name.

**Vendor i Class Identifier**

Configuration range: 1~64 characters

Function: Configure the client Vendor Class Identifier allocated by DHCP server.

**Vendor i Specific Information**

Configuration range: 1~64 hexadecimal numbers

Function: Configure the client Vendor Specific Information allocated by DHCP server.

4. Configure excluded IP addresses(IP addresses are not allocated dynamically in the DHCP address pool), as shown below.

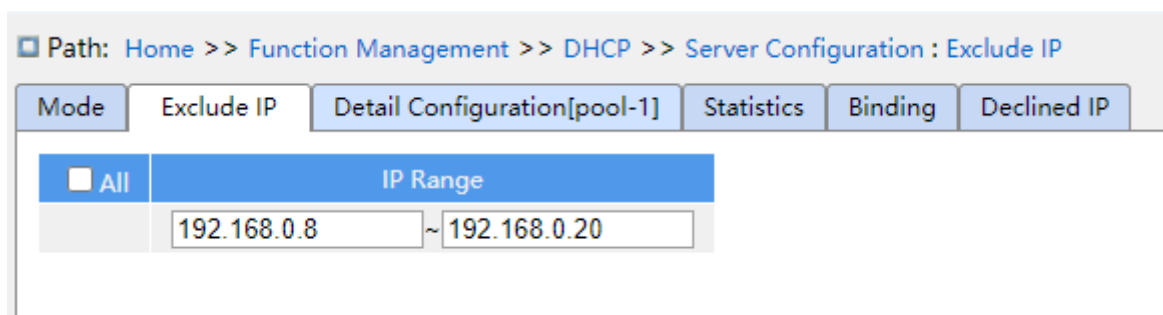

Figure 183 Configure Excluded IP Addresses

**IP Range**

Function: Configure the range of IP addresses are not allocated dynamically in the DHCP address pool. When allocating IP addresses, the DHCP server must eliminate the occupied IP address (for example, IP addresses of the gateway and DNS server). Otherwise, the same IP address may be allocated to two clients, causing IP address conflict.

5. View DHCP server statistics information, as shown below.



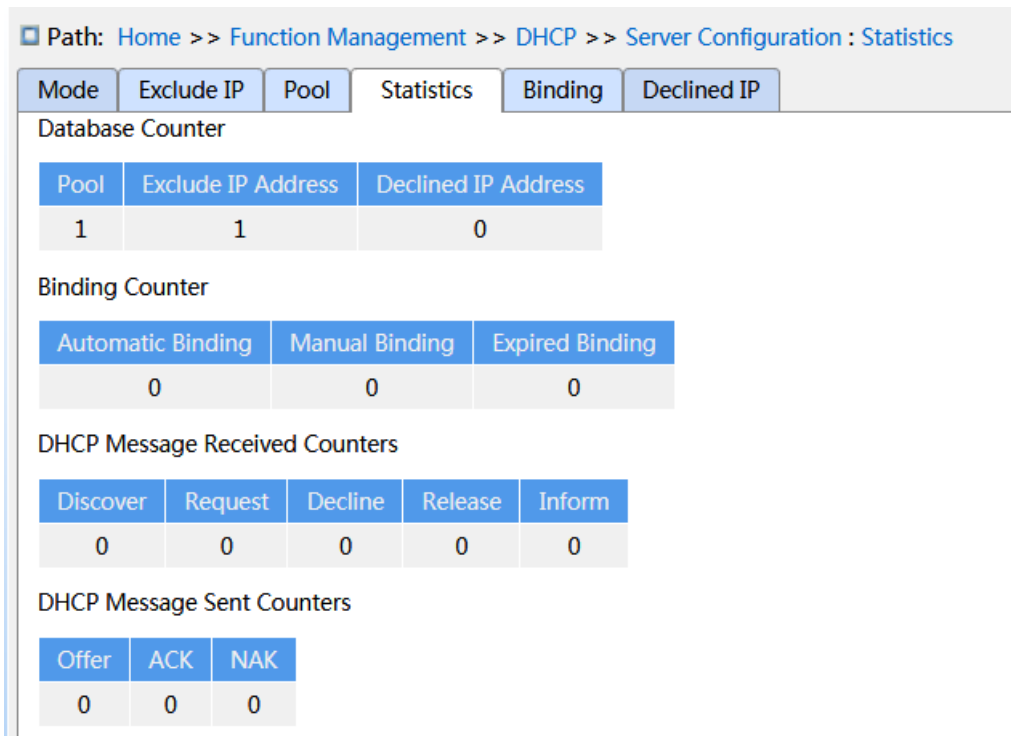

Figure 184 View DHCP Server Statistics Information

6. View information about IP addresses allocated by the DHCP server, as shown below.

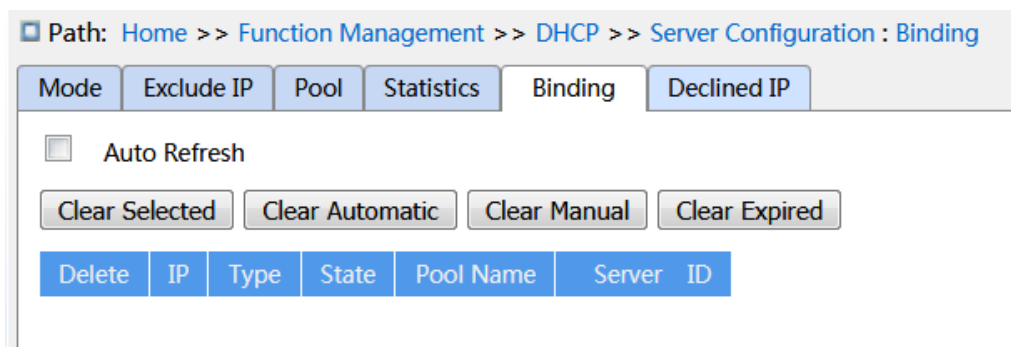

Figure 185 View Information About IP Addresses Allocated by the DHCP Server

Function: Displays information about the IP addresses that have been currently assigned via DHCP. ip: IP address that has been assigned. Type: The type of the assigned address. Status: The usage status of the assigned IP address. Address pool name: The name of the address pool used to assign the IP address. Server ID: The server identification ID used to assign the IP address.

7. View the IP addresses declined by DHCP clients, as shown below.

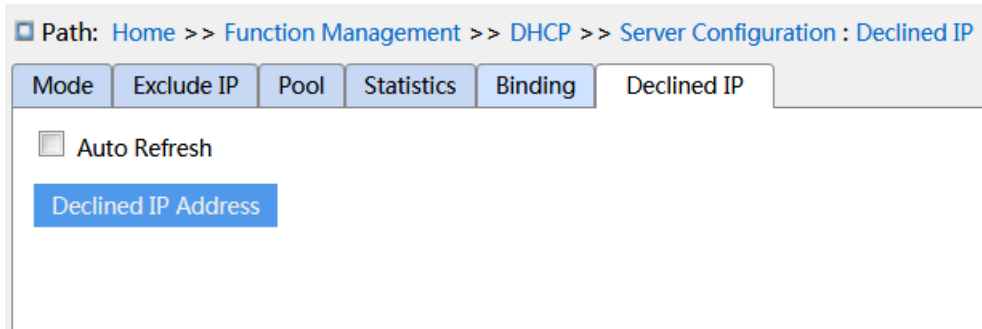

Figure 186 View the IP addresses Declined by DHCP Clients

When a client detects that an IP address allocated by the server conflicts with a static IP address in the same network segment, it sends a decline packet to the server to reject this IP address. The server records the IP address rejected by the client, and will not allocate this IP address to other clients within a certain period of time.

#### 7.11.1.4 Typical Configuration Example

As Figure 187 shows, switch A works as a DHCP server and switch B works as a DHCP client. The port 3 of Switch A connects with the port 4 of Switch B. The client sends out IP address request messages and the server can allocate an IP address to the client in two ways. The excluded IP address range is 192.168.0.1~192.168.0.10 when DHCP server dynamically allocates IP address.

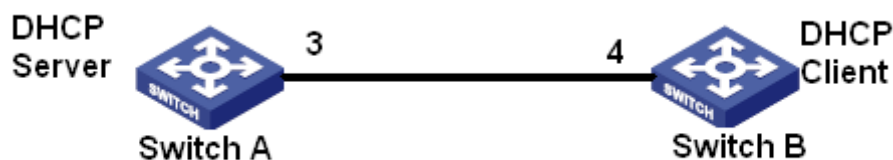

Figure 187 DHCP Typical Configuration Example

#### Statically allocate IP address

➤ Switch A configuration:

1. Enable DHCP server status in correspond VLANs, as shown in Figure 180.
2. Create a DHCP IP pool: pool-1, as shown in Figure 181.
3. Set the pool type as Host; IP address as 192.168.0.6; mask as 255.255.255.0; Bind the MAC address of switch B: 00-11-22-33-44-55, as shown in Figure 182.

➤ Switch B configuration:

1. Set switch B automatically obtains an IP address through DHCP.
2. The switch B obtains the IP address of 192.168.0.6 and the subnet mask of 255.255.255.0 from the DHCP server, as shown in Figure 188.

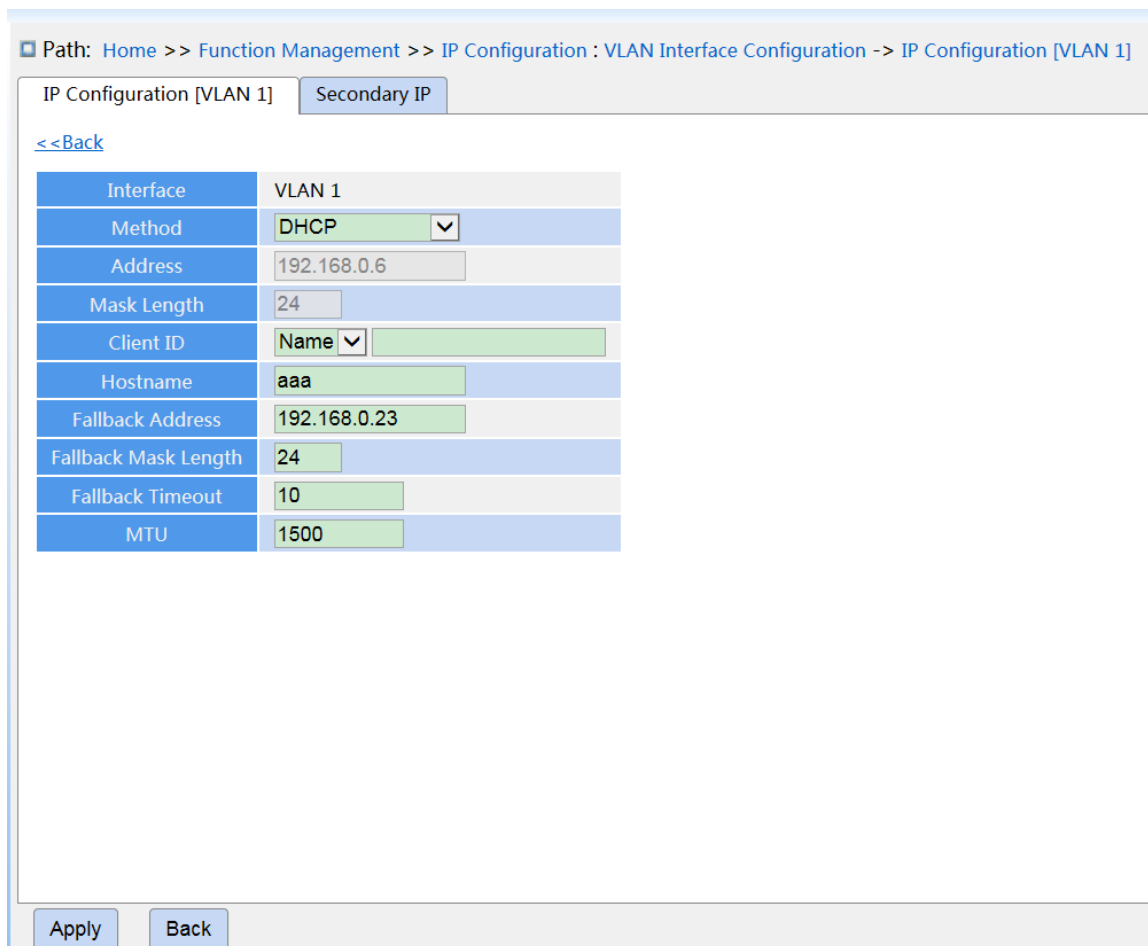

Figure 188 DHCP Client Obtain IP Address-1

### Dynamically allocate IP address

➤ Switch A configuration:

1. Enable DHCP server status in correspond VLANs, as shown in Figure 180.
2. Create a DHCP IP pool: pool-1, as shown in Figure 181.
3. Set the pool type as Network; IP address as 192.168.0.6; mask as 255.255.255.0, the rest is the Default configuration.
4. Configure excluded IP address range as 192.168.0.1~192.168.0.10, as shown in Figure 183.

➤ Switch B configuration:

1. Set switch B automatically obtains an IP address through DHCP.

2. DHCP server searches the assignable IP addresses in the address pool in order and allocates the first found assignable IP address and other network parameters to Switch B. The subnet mask is 255.255.255.0, as shown in Figure 189.

Path: Home >> Function Management >> IP Configuration : VLAN Interface Configuration -> IP Configuration [VLAN 1]

IP Configuration [VLAN 1] Secondary IP

<<Back

Interface	VLAN 1
Method	DHCP
Address	192.168.0.11
Mask Length	24
Client ID	Name
Hostname	bbb
Fallback Address	192.168.0.24
Fallback Mask Length	24
Fallback Timeout	10
MTU	1500

Apply Back

Figure 189 DHCP Client Obtain IP Address-2

### 7.11.2 DHCP Snooping

#### 7.11.2.1 Introduce

DHCP Snooping is a monitoring function of DHCP services on layer 2 and is a security feature of DHCP, ensuring the security of the client further. The DHCP Snooping security mechanism can control that only the trusted port can forward the request message of the DHCP client to the legal server, meanwhile, it can control the source of the response message of the DHCP server, ensuring the client to obtain an IP address from the valid server and preventing the fake or invalid DHCP server from allocating IP addresses or other configuration parameters to other hosts.

DHCP Snooping security mechanism divides port to trusted port and untrusted port.

Trusted port: it is the port that connects with the valid DHCP server directly or indirectly.

Trusted port normally forwards the request messages of DHCP clients and the response messages of DHCP servers to guarantee that DHCP clients can obtain valid IP addresses.

Untrusted port: it is the port that connects with the invalid DHCP server. Untrusted port does not forward the request messages of DHCP clients and the response messages of DHCP servers to prevent DHCP clients from obtaining invalid IP addresses.

### 7.11.2.2 Web Configuration

1. Enable DHCP Snooping function, as shown below.

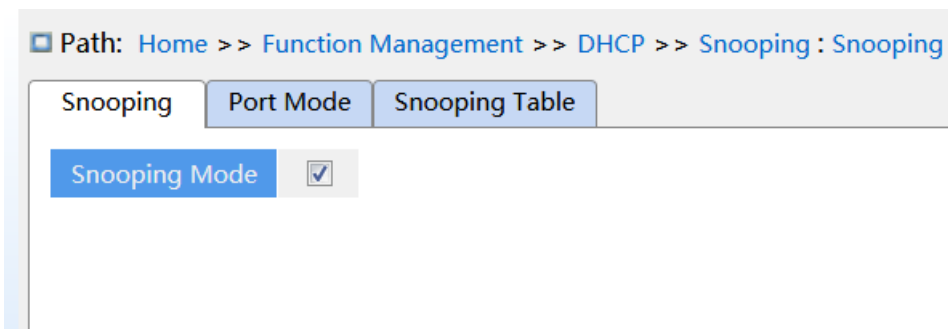

Figure 190 DHCP Snooping State

#### DHCP Snooping Mode

Configuration options: Enable/Disable

Default configuration: Disable

Function: Enable/Disable switch DHCP Snooping function.



**Caution:**

The switch working as DHCP server and client cannot enable DHCP Snooping function.

2. Configure trusted ports, as shown below.

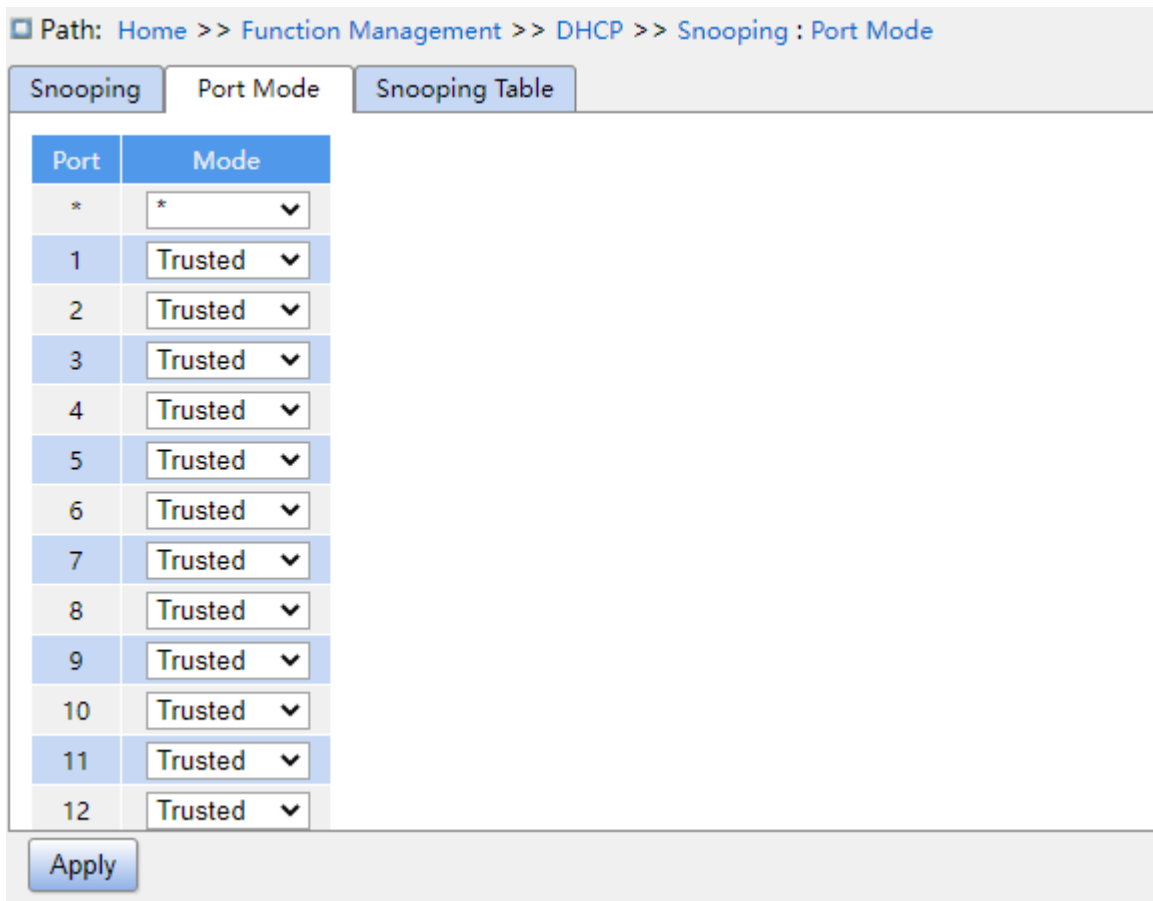

Figure 191 Configure Trust Port

**Mode**

Configuration options: Trusted/Untrusted

Default configuration: Untrusted

Function: set the port to a trusted port or an untrusted port. The ports that connect with valid DHCP servers directly or indirectly are trusted ports.

3. View DHCP snooping entries, as shown below.

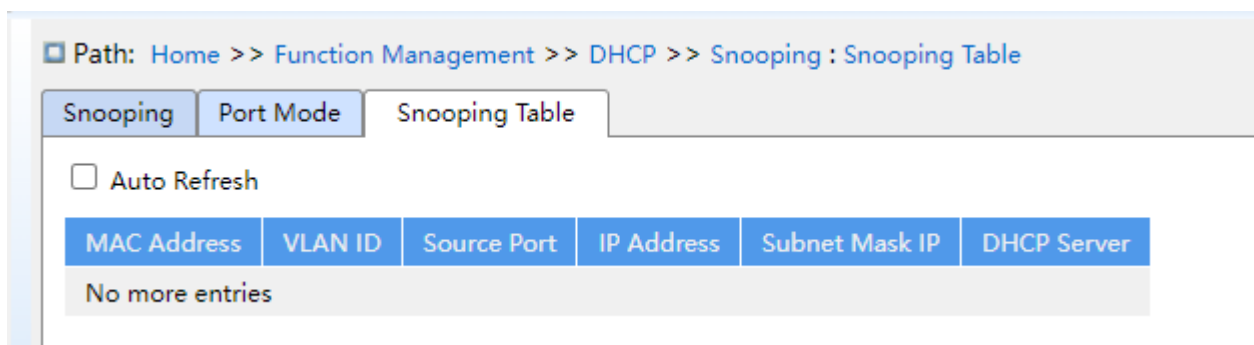

Figure 192 View DHCP snooping entries

### 7.11.2.3 Typical Configuration Example

As Figure 193 shows, the DHCP client requests an IP address from the DHCP server. An unauthorized DHCP server exists in the network. Set port 1 to a trusted port by DHCP Snooping to forward the request message of the DHCP client to the DHCP server and forward the response message of the DHCP server to the DHCP client. Set port 3 to an untrusted port that cannot forward the request message of the DHCP client and the response message of the unauthorized DHCP server, ensuring that the client can obtain a valid IP address from the valid DHCP server.

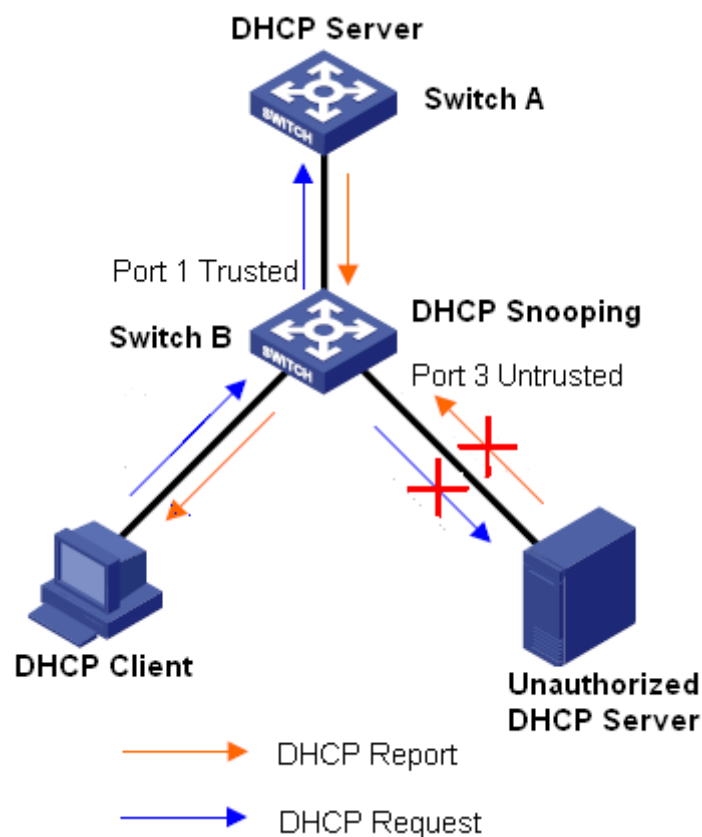

Figure 193 DHCP Snooping Typical Configuration Example

Switch B configuration:

- Enable DHCP Snooping function, as shown in Figure 190.
- Set the port 1 of switch B to a trusted port and set the port 3 to an untrusted port, as shown in Figure 191.

### 7.11.3 DHCP Relay

#### 7.11.3.1 Introduction

##### 1. DHCP Realy

DHCP relay is the forwarding of DHCP packets between the DHCP server and the client. When the DHCP client is not on the same subnet as the server, there must be a DHCP relay to forward DHCP request and reply messages. The data forwarding of the DHCP relay is different from the normal route forwarding. The normal route forwarding is relatively transparent, and the device generally does not modify the IP packet content. However, after receiving the DHCP message, the DHCP relay will regenerate a DHCP message and then forward it out. In the view of the DHCP client, the DHCP relay agent is like a DHCP server; in the view of the DHCP server, the DHCP relay agent is like a DHCP client.

The DHCP relay forwards the received DHCP request packet to the DHCP server in unicast mode, and forwards the received DHCP response packet to the DHCP client. The DHCP relay is equivalent to a forwarding station and is responsible for communicating DHCP clients and DHCP servers located on different network segments. It realizes dynamic IP management for multiple network segments as long as a DHCP server is installed, that is, DHCP dynamic IP management in Client-Relay-Server mode, as shown below.

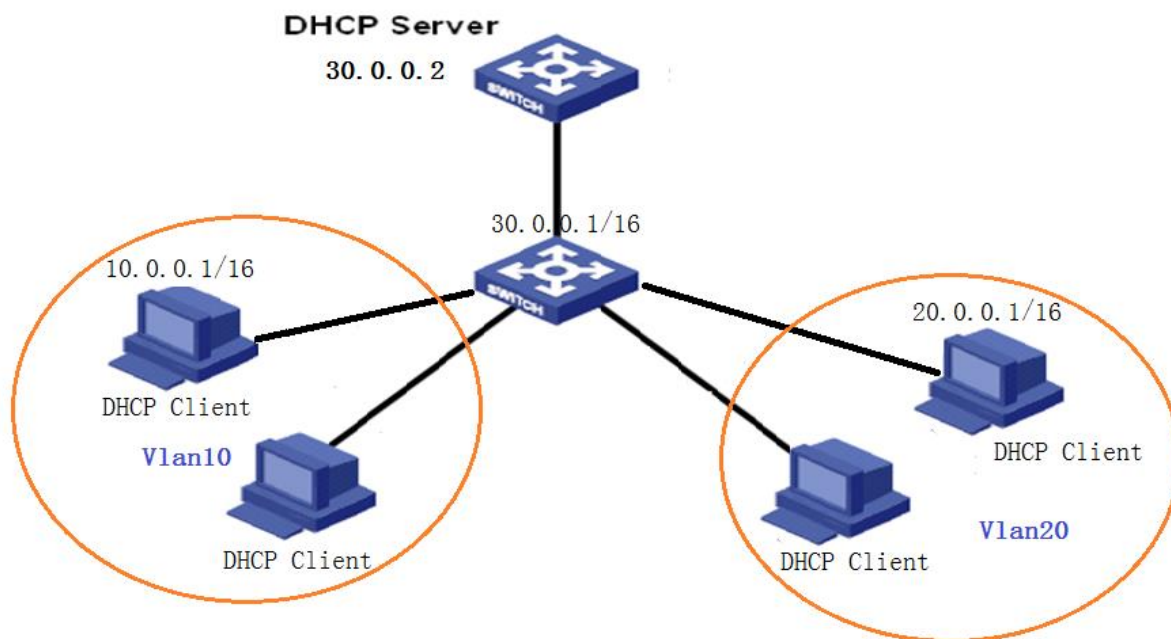

Figure 194 Client—Relay—Server Mode



## 2. DHCP Relay Agent Information (option 82)

When the relay device performs DHCP relay, you can add some options to specify some network information of the DHCP client, so that the server can assign different IP addresses to users according to more accurate information. According to RFC3046, the option number of the option used is 82, so it is also called option 82.

Option 82 (Relay Agent Information Entry) records the client information. When the Option 82 supported DHCP Snooping receives the request message from the DHCP client, it add the corresponding Option 82 field into the messages and then forward the message to the DHCP server. The server supporting Option 82 can flexibly allocate addresses according to the Option 82 message.

Once Option 82 is enabled, the Option 82 field will be added into the message. The Option 82 field of this series switches contains two sub-options: sub-option 1 (Circuit ID) and sub-option 2 (Remote ID). The formats of two sub-options are shown below:

- Sub-option 1 contains the VLAN ID and number of the port that receives the request message from the DHCP client, as shown in Table 7

Table 7 Sub-option 1 Field Format

Sub-option type (0x01)	Length (0x04)	VLAN ID	Port number
One byte	One byte	Two bytes	Two bytes

Sub-option type: the type of the sub-option 1 is 1.

Length: the number of bytes that VLAN ID and Port number occupy.

VLAN ID: On DHCP Relay device, the VLAN ID of the port that receives the request message from the DHCP client.

Port number: On DHCP Realy device, the number of the port that receives the request message from the DHCP client.

- The content of Sub-option 2 is the MAC address of the DHCP Relay device that receives the request message from the DHCP client, as shown in Table 8.

Table 8 Sub-option 2 Field Format-MAC Address

Sub-option type (0x02)	Length (0x06)	MAC Address

One byte	One byte	6 bytes
----------	----------	---------

Sub-option type: the type of the sub-option 2 is 2

Length: the number of bytes that sub-option2 content occupies. MAC address occupies 6 bytes and character string occupies 16 bytes.

MAC address: the content of sub-option2 is the MAC address of the DHCP Realy device that receives the request message from the DHCP client.

If DHCP Relay supports Option 82 function, when the DHCP Relay receives a DHCP request message, it will process the request message according to whether the message contains Option 82 and the client policy, and then forward the processed message to the DHCP server. The specific processing method is shown in Table 9.

Table 9 The treatment request message by DHCP Relay

Receive the request message from the DHCP client	Configuration policy	DHCP Relay device processing the request message
The request message contains Option 82	Drop	Drop the request message
	Keep	Keep the message format unchanged and forward the message
	Replace	Replace the Option 82 field in the message with the Option 82 field of the Snooping device and forward the new message
The request message does not contain Option 82	Drop/Keep/Replace	Add the Option 82 field of the Relay device into the message and forward it

When the DHCP Relay device receives the response message from the DHCP server, if the message contains Option 82 field, remove the Option 82 field and forward the message to the client.

### 7.11.3.2 Web Configuration

1. DHCP Relay Global Configuration, as shown below.

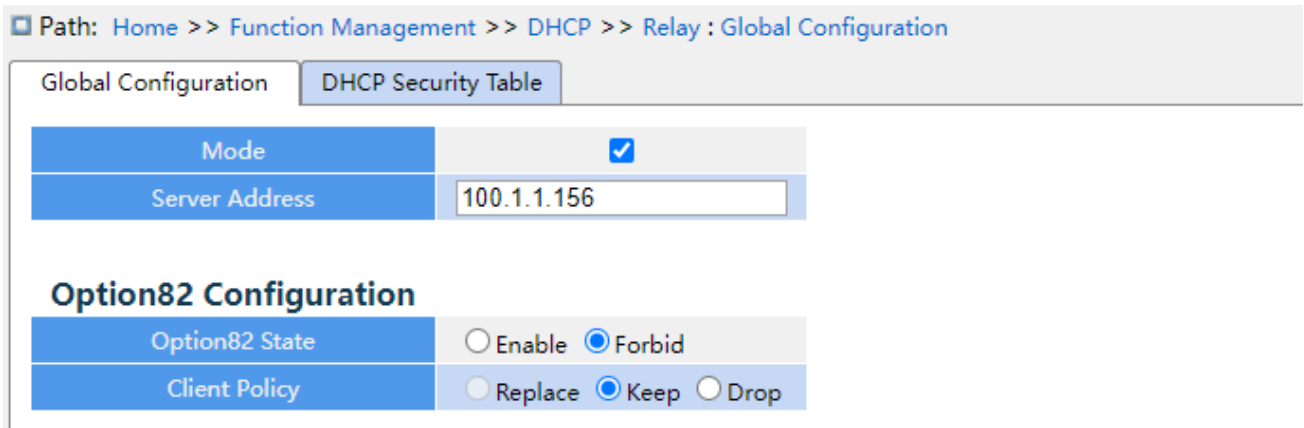

Figure 195 DHCP Relay Global Configuration

**Mode**

Configuration options: Enable/disable

Default configuration: Disable

Function: whether enable DHCP relay.

**Server Address**

Function: configure DHCP server address.

**Option82 Sate**

Configuration options: Enable/forbid

Default configuration: Forbid

Function: whether enable option82 DHCP relay.

**Client Policy**

Configuration options: Replace/keep/drop

Default configuration: Keep

Function: configure the client policy, DHCP relay process the request message sent by client according to the client policy. The specific treatment as shown in Table 9.

2. View DHCP Security table items, as shown below.

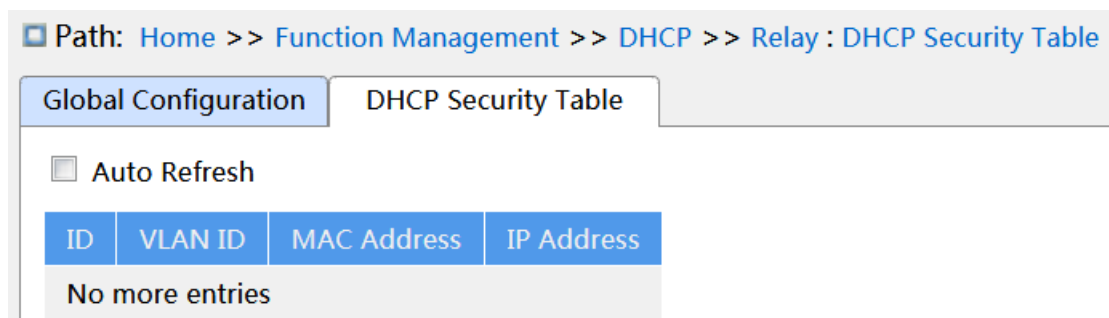

Figure 196 view DHCP Security Table

### 7.11.3.3 Typical Configuration Example

As shown below, Switch A as the DHCP server, switch B as the DHCP relay, switch C as the DHCP client, and port 1 of switch A connect to port 1 of switch B, port 2 of switch B connect to port 2 of switch C. DHCP server is not in the same LAN as DHCP client. Client dynamically obtain IP address and other network parameters by DHCP mode through DHCP relay.



Figure 197 DHCP typical configuration example

➤ Switch A configuration:

1. Create the VLAN1 and configure the IP: 100.1.1.156, as shown in Figure 107;
2. Open the dhcp server state on the VLAN 1, as shown in Figure 107;
3. Create the address pool pool-33, as shown in Figure 181;
4. elect the address pool type as Network; IP address: 33.1.1.6; Mask: 255.0.0.0;

➤ Switch B configuration:

1. Create the VLAN1 and configure the IP: 100.1.1.180, as shown in Figure 107;
2. Create the VLAN33 and configure IP: 33.1.1.2, as shown in Figure 107;
3. Enable DHCP relay, as shown in Figure 195;
4. Configure server IP address: 100.1.1.156, as shown in Figure 195;

➤ Switch C configuration:

1. Create VLAN33 and enable DHCP Client, as shown in Figure 107;
2. Switch A assign IP address 33.0.0.1 to switch C.

## 7.12 IEEE802.1X Configuration

### 7.12.1 Introduction

To ensure WLAN security, IEEE802 LAN/WAN committee proposed the 802.1X protocol. As a common access control mechanism for LAN ports in Ethernet, 802.1X implements Ethernet authentication and security. 802.1X is a port-based network access control. Port-based network access control is to implement authentication and control on the ports of LAN access devices. If a user passes the authentication, it can access the resources in the LAN. If it cannot pass the authentication, it cannot access the resources in the LAN. 802.1X systems adopt the Client/Server structure, as shown in below. User authentication and authorization of port-based access control requires the following elements:

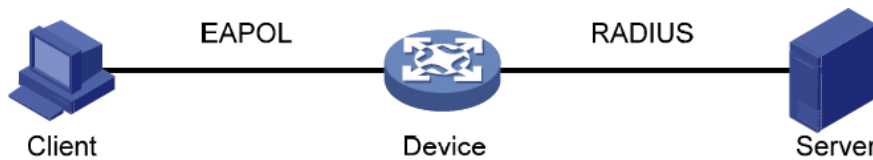

Figure 198 IEEE802.1X Structure

**Client:** usually indicates a user terminal. When a user wants to surf the Internet, it starts the client program and enters required user name and password. The client program will send a connection request. The client should support EAPOL (Extensible Authentication Protocol over LAN).

**Device:** indicates the authentication switch in an Ethernet system. It uploads and delivers user authentication information, and enables or disables a port based on the authentication result.

**Authentication server:** indicates the entity that provides authentication service for devices. It checks whether users have the permissions to use network services according to the identifiers (user names and passwords) sent by clients, and enables or disables ports according to authentication results.

### 7.12.2 Web Configuration

1. 802.1X Task Manager Configuration, as shown below.

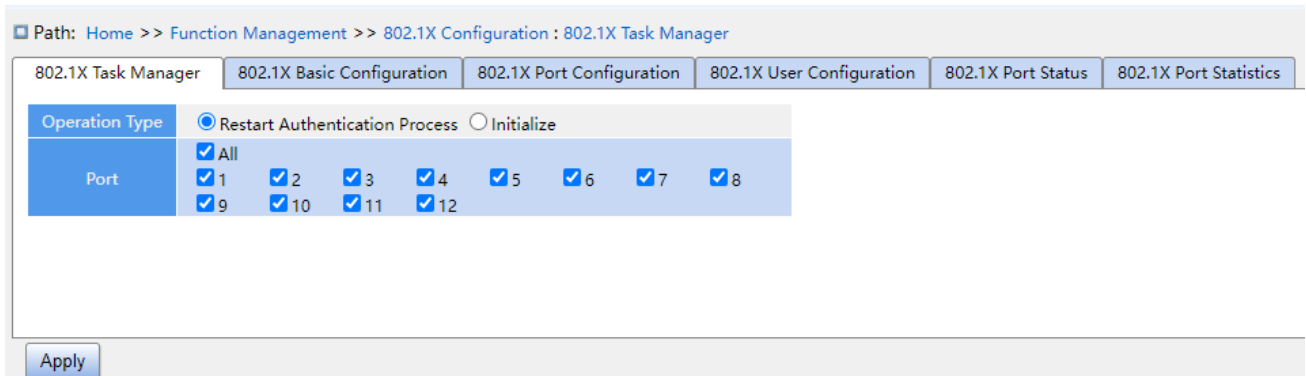

Figure 199 Task Manager configuration

### Operation Type

Configuration options: Restart Authentication Process /initialization

Function: When the port selects **Mac-Based** and **port-based** 802.1X authentication mode, you can select <Restart Authentication Process>/<Initialize> to re-authenticate. During the re-authentication process, the port status is switched to the unauthenticated state.

### Port

Select the port that needs to Restart Authentication Process /initialize.

2. IEEE802.1X Basic Configuration, as shown below.

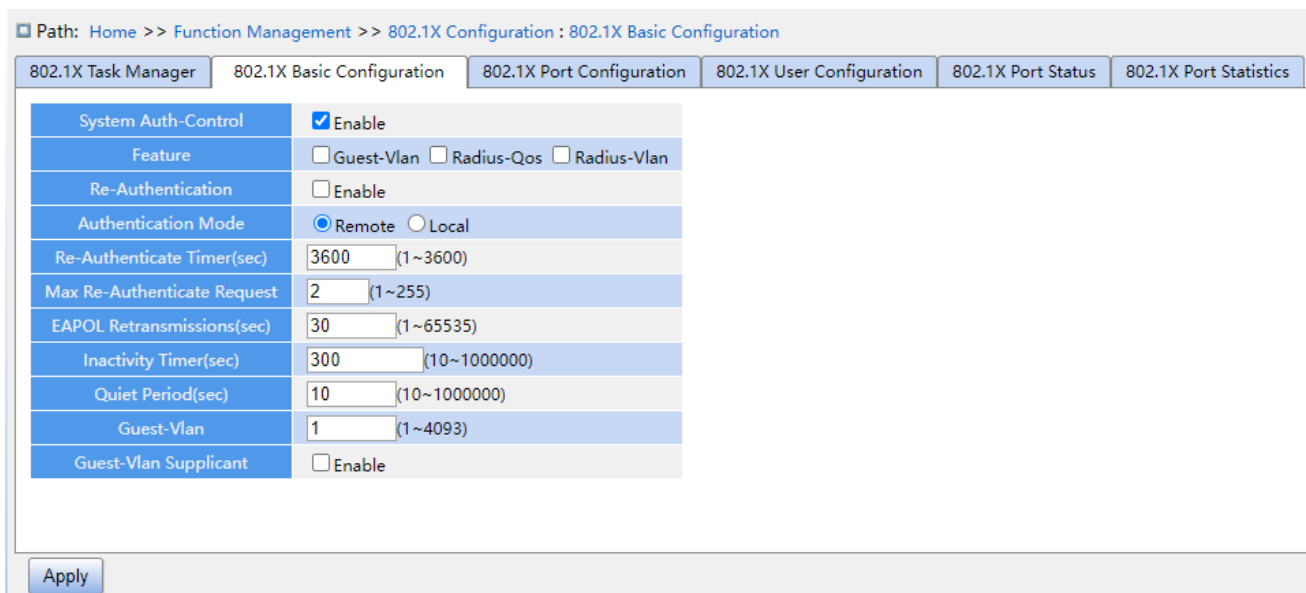

Figure 200 IEEE802.1X Basic Configuration

### System Auth-Control

Configuration options: Enable/Disable

Default configuration: Disable

Function: Enable/Disable global IEEE802.1x security function.

**Guest-VLAN**

Configuration options: Enable/Disable

Default configuration: Disable

Function: When enabled, if a user is not authenticated or fails to be authenticated, the device adds the client authentication port to the guest VLAN. All users that access this port are authorized to access the resources in the guest VLAN.

**RADIUS-QOS**

Configuration options: Enable/Disable

Default configuration: Disable

Function: When enabled, after the client passes authentication, the server transfers authorization information to the device. If **RADIUS-QOS** is checked on the server, the authorization information includes CoS information assigned for authorization. The equipment will modify the CoS value of the client authentication port based on the assigned value.

**RADIUS-VLAN**

Configuration options: Enable/Disable

Default configuration: Disable

Function: When enabled, after the client passes authentication, the server transfers authorization information to the device. If **RADIUS-VLAN** is checked on the server, the authorization information includes VLAN information assigned for authorization. The equipment will add the client authentication port to the assigned VLAN.

**Re-Authentication**

Configuration options: Enable/Disable

Default configuration: Disable

Function: Configure whether regular re-authentication is required when authentication succeeds.

**Authentication Mode**

Configuration options: Remote/Local

Default configuration: Remote

Function: Configure the radius authentication mode as remote authentication or local

authentication.

### **Re-Authenticate Timer(sec)**

Configuration range: 1~3600s

Default configuration: 3600s

Function: When authentication succeeds, set the time interval for re-authentication.

“**Re-Authenticate Timer**” can be configured only if enabling “**Re-Authentication**”.

### **Max Re-Authenticate Request**

Configuration range: 1~255

Default configuration: 2

Function: Set the maximum retransmission attempts for Identity EAPOL request packets. If the device still receives no response packets from the client after maximum retransmission attempts, the device will consider authentication fails.

### **EAPOL Retransmissions**

Configuration range: 1~65535s

Default configuration: 30s

Function: Set the overtime for response from the client. After sending a Identity EAPOL request packet, the device will retransmit a Identity EAPOL request packet if it still receives no response from the client after the specified time.

### **Inactivity Timer**

Configuration range :10~1000000s

Default configuration :300s

Function:

After MAC address authentication, if the authentication succeeds, if no packets pass during this time, the corresponding security entry is deleted.

### **Quiet Period(sec)**

Configuration range: 10~1000000s

Default configuration: 10s

Function: If authentication fails, the device enters to quiet period. During the quiet period, the device does not respond to authentication requests from the client.

### **Guest-VLAN**



Configuration range: 1~4095

Default configuration: 1

Function: Configure guest VLAN ID .

### Guest-VLAN Supplicant

Configuration options: Enable/Disable

Default configuration: Disable

Function: When enabled, if a user is not authenticated or fails to be authenticated, the device adds the client authentication port to the guest VLAN. When disabled, the device adds the port to the guest VLAN only when this port has no EAPOL frame record.



#### Caution:

- The precondition for configuring “**Guest-VLAN**”, “**Max Re-Authenticate Request**”, and “**Guest-Vlan Supplicant**” is enabling “**Guest -VLAN**”.
- It is recommended to disable “Radius-Vlan” and “**Guest -VLAN**”, when the authentication port type is Trunk or Hybrid.
- The CoS value assigned for authorization does not change or affect the configuration of the port. However, the priority of the COS value assigned for authorization is higher than a COS value configured by a user. In other words, what is valid after authentication is the CoS value assigned for authorization. If a user fails to be authenticated or goes offline, the CoS value configured by the user take effects.
- The VLAN assigned for authorization or the guest VLAN does not change or affect the configuration of the port. However, the VLAN assigned for authorization or the guest VLAN has a higher priority than a VLAN configured by a user.

After a user initiates authentication, and if the authentication is successful:

If the port enables **RADIUS-VLAN**, the port is added to the VLAN assigned by the RADIUS server.

If the port does not enable **RADIUS-VLAN**, the port is added to the VLAN configured by the user.

If a user fail to be authenticated or goes offline:

If the port enables **Guest-VLAN** and **Guest-Vlan Supplicant**, the port is added to the VLAN.

If the port enables **Guest-VLAN** but does not enable **Guest-Vlan Supplicant**, the port is added to the guest VLAN when no EAPOL fame record is available, and is added to the VLAN configured by the user when EAPOL frame record is available.

If the port does not enable **Guest-VLAN**, the port is added to the VLAN configured by the user.

### 3. Configure IEEE802.1X port, as shown below.

Path: Home >> Function Management >> 802.1X Configuration : 802.1X Port Configuration

802.1X Task Manager | 802.1X Basic Configuration | 802.1X Port Configuration | 802.1X User Configuration | 802.1X Port Status | 802.1X Port Statistics

Port	Admin State	Guest-Vlan	Radius-Qos	Radius-Vlan
1	Force-Authorized	<input checked="" type="checkbox"/> Enable	<input checked="" type="checkbox"/> Enable	<input type="checkbox"/> Enable
2	Force-Authorized	<input type="checkbox"/> Enable	<input type="checkbox"/> Enable	<input type="checkbox"/> Enable
3	Force-Authorized	<input type="checkbox"/> Enable	<input type="checkbox"/> Enable	<input type="checkbox"/> Enable
4	Force-Authorized	<input type="checkbox"/> Enable	<input type="checkbox"/> Enable	<input type="checkbox"/> Enable
5	Force-Authorized	<input type="checkbox"/> Enable	<input type="checkbox"/> Enable	<input type="checkbox"/> Enable
6	Force-Authorized	<input type="checkbox"/> Enable	<input type="checkbox"/> Enable	<input type="checkbox"/> Enable
7	Force-Authorized	<input type="checkbox"/> Enable	<input type="checkbox"/> Enable	<input type="checkbox"/> Enable
8	Force-Authorized	<input type="checkbox"/> Enable	<input type="checkbox"/> Enable	<input type="checkbox"/> Enable
9	Force-Authorized	<input type="checkbox"/> Enable	<input type="checkbox"/> Enable	<input type="checkbox"/> Enable
10	Force-Authorized	<input type="checkbox"/> Enable	<input type="checkbox"/> Enable	<input type="checkbox"/> Enable
11	Force-Authorized	<input type="checkbox"/> Enable	<input type="checkbox"/> Enable	<input type="checkbox"/> Enable
12	Force-Authorized	<input type="checkbox"/> Enable	<input type="checkbox"/> Enable	<input type="checkbox"/> Enable

Apply

Figure 201 Configure IEEE802.1X port

#### Port

Configuration options: all switch ports.

#### Admin State

Configuration options: Force Authorized/Force Unauthorized/Port-based/MAC-based

Default configuration: Force Authorized

Function: Select the port authentication mode.

Description: **Force Authorized** means port is always in an authorized state and allows users to access network resource without authentication.

**Force Unauthorized** means the port is always in unauthorized state and does not allow users to conduct authentication and the switch does not provide authentication services to clients that access the switch from this port. **MAC-based** indicates that users using the port need to be authenticated respectively. When a user is offline, only the user cannot use the

network. **Port-based** indicates that users are authenticated based on port. After the first user using the port passes authentication, all the other users using the port do not need to be authenticated. However, when the first user is offline, the port is disabled and all the other users using the port cannot use the network.

**RADIUS-QOS**

Configuration options: Enable/ Disable

Default configuration: Disable

Function: Enable or disable RADIUS-Assigned QoS on port.

**RADIUS-VLAN**

Configuration options: Enable/ Disable

Default configuration: Disable

Function: Enable or disable RADIUS-Assigned VLAN on port.



**Note:**

This function is available only when **RADIUS-QOS / RADIUS-VLAN** is enabled at both the global and port levels.

4. IEEE802.1X User Configuration, as shown below.

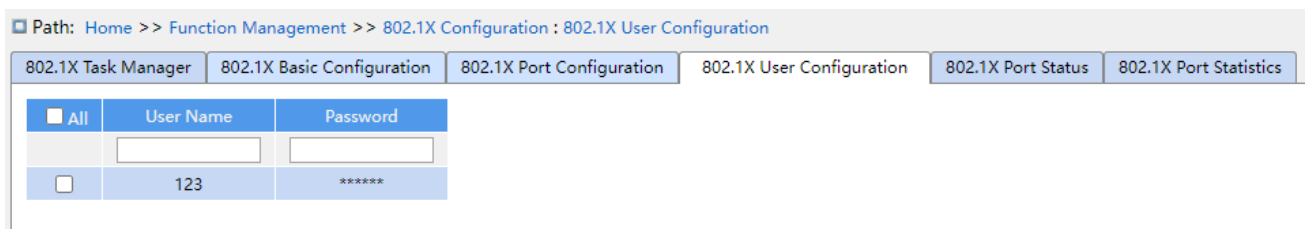

Figure 202 IEEE802.1X User Configuration

**User Name**

Configuration range: 1-16 character

Default configuration: None

Function: Configure the local authentication username.

**Password**

Configuration range: 1-16 character

Default configuration:None

Function: Configure the local authentication password.

5. View IEEE802.1X Port Status, as shown below.

Path: Home >> Function Management >> 802.1X Configuration : 802.1X Port Status

Port	Admin State	Port Status	Last Src	Last ID	QoS	VLAN	Guest
1	Force-Authorized	DOWN	--	--	--	--	--
2	Force-Authorized	DOWN	--	--	--	--	--
3	Force-Authorized	DOWN	--	--	--	--	--
4	Force-Authorized	DOWN	--	--	--	--	--
5	Force-Authorized	DOWN	--	--	--	--	--
6	Force-Authorized	DOWN	--	--	--	--	--
7	Force-Authorized	Authorized	--	--	--	--	--
8	Force-Authorized	DOWN	--	--	--	--	--
9	Force-Authorized	DOWN	--	--	--	--	--
10	Force-Authorized	DOWN	--	--	--	--	--
11	Force-Authorized	DOWN	--	--	--	--	--
12	Force-Authorized	DOWN	--	--	--	--	--

Refresh

Figure 203 IEEE802.1X Port Status

**Port Status**

Configuration options: Globally Disabled, Authorized, Unauthorized, Link Down, x Auth/y Unauth

Disable、Auth、UnAuth、DOWN、x A/y UnA

Function: Display port authentication state. **Disable** indicates IEEE802.1X is diabled globally; **Auth** indicates the user connected to the port passes authentication; **UnAuth** indicates the user connected to the port fails to pass authentication; **DOWN** indicates the port is link down; **x A/y UnA** indicates x users are authorized and y users are unauthorized when the port authentication mode is MAC-based Auth.

6. View IEEE802.1X statistic, as shown below.

Path: Home >> Function Management >> 802.1X Configuration : 802.1X Port Statistics

802.1X Task Manager | 802.1X Basic Configuration | 802.1X Port Configuration | 802.1X User Configuration | 802.1X Port Status | 802.1X Port Statistics

Auto Refresh

[Expand Filter](#)

<input type="checkbox"/> All	Port	EAPOL		Radius		Local		<a href="#">Details</a>
		RX	TX	Successes	Failures	Match	Mismatch	
<input type="checkbox"/>	1	0	0	0	0	0	0	<a href="#">Details</a>
<input type="checkbox"/>	2	0	0	0	0	0	0	<a href="#">Details</a>
<input type="checkbox"/>	3	0	0	0	0	0	0	<a href="#">Details</a>
<input type="checkbox"/>	4	0	0	0	0	0	0	<a href="#">Details</a>
<input type="checkbox"/>	5	0	0	0	0	0	0	<a href="#">Details</a>
<input type="checkbox"/>	6	0	0	0	0	0	0	<a href="#">Details</a>
<input type="checkbox"/>	7	0	1	0	0	0	0	<a href="#">Details</a>
<input type="checkbox"/>	8	0	0	0	0	0	0	<a href="#">Details</a>
<input type="checkbox"/>	9	0	0	0	0	0	0	<a href="#">Details</a>
<input type="checkbox"/>	10	0	0	0	0	0	0	<a href="#">Details</a>
<input type="checkbox"/>	11	0	0	0	0	0	0	<a href="#">Details</a>
<input type="checkbox"/>	12	0	0	0	0	0	0	<a href="#">Details</a>

Figure 204 View IEEE802.1X Statistics

Click port **Details** to enter the IEEE802.1X information statistics interface of the corresponding port, as shown below.

[<<Back](#)

Statistics		
Eapol	Rx Total	0
	Tx Total	0
	Rx RespId	0
	Tx ReqId	0
	Rx RespMD5	0
	Tx ReqMD5	0
	Rx Resp	0
	Tx Req	0
	Rx Start	0
	Rx LogOff	0
	Rx Invalid Type	0
	Rx Invalid Len	0
	Radius	Rx Access Challenges
Rx Other Requests		0
Rx Auth Successes		0
Rx Auth Failures		0
Tx Responses		0
Mac Address		--
Local	MD5-Challenge Match	0
	MD5-Challenge Mismatch	0
	Error User	0
	Error Decode	0
	Error InvalidMethod	0

Figure 205 View detailed statistics of IEEE802.1X ports

### 7.12.3 Typical Configuration Example

As shown below, client is connected to port 1 of the switch. Enable IEEE802.1x on port 1 and select **Port-based** authentication mode. The username and password of the remote authentication are both ddd, the rest of the configuration are the default.

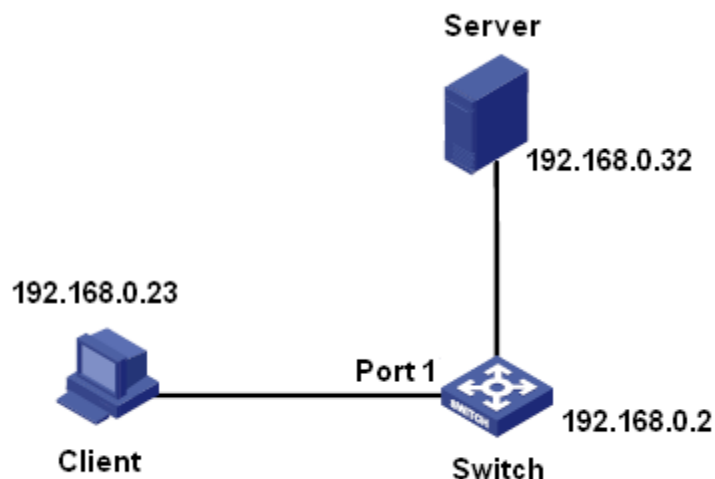

Figure 206 IEEE802.1x Configuration Example

You can refer to the typical configuration example in “5.6 RADIUS Configuration”.

## 7.13 GMRP

### 7.13.1 GARP Introduction

The Generic Attribute Registration Protocol (GARP) is used for spreading, registering, and cancelling certain information (VLAN, multicast address) among switches on the same network.

With GARP, the configuration information of a GARP member will spread the information to the entire switching network. A GARP member instructs the other GARP members to register or cancel its own configuration information by means of join/leave message respectively. The member also registers or cancels the configuration information of other members based on join/leave messages sent by other members.

GARP involves three types of messages: Join, Leave, and LeaveAll.

- When a GARP application entity wants to register its own information on other switches, the entity sends a Join message. Join messages fall into two types: JoinEmpty and JoinIn. A JoinIn message is sent to declare a registered attribute, while a JoinEmpty message is sent to declare an attribute that is not registered yet.
- When a GARP application entity wants to cancel its own information on other switches, the entity sends a Leave message. Leave messages fall into two types: LeaveEmpty and

LeaveIn. A LeaveIn message is sent to cancel a registered attribute, while a LeaveEmpty message is sent to cancel an attribute that is not registered yet.

- After a GARP entity starts, it starts the LeaveAll timer. When the timer expires, the entity sends a LeaveAll message.

**Note:**

An application entity indicates a GARP-enabled port.

---

GARP timers include Hold timer, Join timer, Leave timer, and LeaveAll timer.

**Hold Timer:** When receiving a registration message, a GARP entity does not send a Join message immediately, but starts Hold timer. When the timer expires, the entity sends all the registration messages received within the preceding period in one Join message, reducing packet sending for better network stability.

**Join Timer:** To ensure that Join messages are received by other application entities, a GARP application entity starts Join timer after sending a Join message. If receiving no JoinIn message before Join timer expires, the entity sends the Join message again. If receiving a JoinIn message before the timer expires, the entity does not send the second Join message.

**Leave Timer:** When a GARP application entity wants to cancel the information about an attribute, the entity sends a Leave message. The entity receiving the message starts Leave timer. If receiving no Join message before the timer expires, the entity receiving the message cancels the information about the attribute.

**LeaveAll Timer:** As a GARP application entity starts, it starts LeaveAll timer. When the timer expires, the entity sends a LeaveAll message, so that the other GARP application entities re-register all the attributes. Then the entity starts LeaveAll timer again for the new cycle.

### 7.13.2 GMRP Protocol

The GARP Multicast Registration Protocol (GMRP) is a multicast registration protocol based on GARP. It is used for maintaining the multicast registration information of switches. All GMRP-enabled switches can receive multicast registration information from other switches, update local multicast registration information dynamically, and spread local multicast registration information to other switches. This information exchange mechanism ensures



the consistency of multicast information maintained by all GMRP-enabled switches on a network.

If a switch or terminal wants to join or leave a multicast group, the GMRP-enabled port broadcasts the information to all the ports in the same VLAN.

### 7.13.3 Explanation

Agent port: indicates the port on which GMRP and the agent function are enabled.

Propagation port: indicates the port on which only GMRP is enabled, but not the proxy function.

Dynamically learned GMRP multicast entry and agent entry are forwarded by the propagation port to the propagation ports of the lower-level devices.

All GMRP timers on the same network must keep consistent to prevent mutual interference. The timers should comply with the following rules: Hold timer < Join timer, 2 \* Join timer < Leave timer, and Leave timer < LeaveAll timer.

### 7.13.4 Web Configuration

1. Enable the global GMRP protocol and configure the global timer, as shown below.

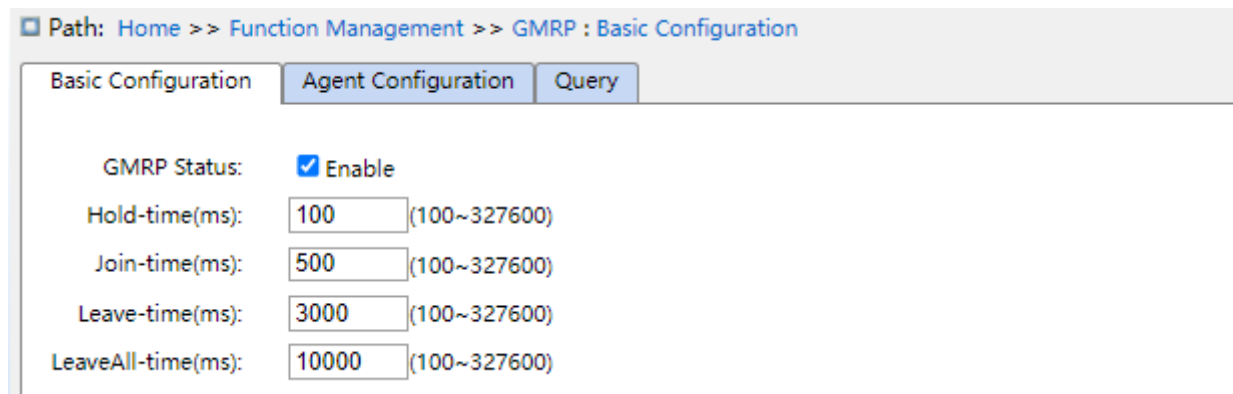

Figure 207 GMRP Global Configuration

#### GMRP Status

Configuration options: Enable/Disable

Default configuration: Disable

Function: Enable/Disable the global GMRP function. The function cannot be used together with the IGMP Snooping function.

**Hold-timer**

Configuration range: 100ms~327600ms

Default configuration: 100ms

Description: This value must be a multiple of 100. It is better to set same time of Hold timers on all GMRP-enabled ports

**Join-timer**

Configuration range: 100ms~327600ms

Default configuration: 500ms

This value must be a multiple of 100. It is better to set same time of Join timers on all GMRP-enabled ports

**Leave-timer**

Configuration range: 100ms~327600ms

Default configuration: 3000ms

This value must be a multiple of 100. It is better to set same time of Leave timers on all GMRP-enabled ports.

**LeaveAll-timer**

Configuration range: 100ms~327600ms

Default configuration: 10000ms

Function: The time interval for sending LeaveAll packets. The value must be a multiple of 100.

Explanation: if different devices' LeaveAll timers expire at the same time, they will send multiple LeaveAll messages at the same time, which increases message quantity. In order to avoid the expiration of LeaveAll timers of different devices at the same time, the actual running time of LeaveAll timer is a random value that is longer than the time of one LeaveAll timer, and less than 1.5 times of LeaveAll timer.

2. Configure GMPR function on port, as shown below.

Port	GMRP Enable	GMRP Agent Enable	Last PDU Origin
1	<input checked="" type="checkbox"/>	<input checked="" type="checkbox"/>	00-00-00-00-00-00
2	<input checked="" type="checkbox"/>	<input checked="" type="checkbox"/>	00-00-00-00-00-00
3	<input type="checkbox"/>	<input type="checkbox"/>	--
4	<input type="checkbox"/>	<input type="checkbox"/>	--
5	<input type="checkbox"/>	<input type="checkbox"/>	--
6	<input type="checkbox"/>	<input type="checkbox"/>	--
7	<input type="checkbox"/>	<input type="checkbox"/>	--
8	<input type="checkbox"/>	<input type="checkbox"/>	--
9	<input type="checkbox"/>	<input type="checkbox"/>	--
10	<input type="checkbox"/>	<input type="checkbox"/>	--
11	<input type="checkbox"/>	<input type="checkbox"/>	--
12	<input type="checkbox"/>	<input type="checkbox"/>	--

Figure 208 Port GMRP Configuration

**GMRP Enable**

Configuration options: Enable/Disable

Default configuration: Disable

Function: Enable GMRP function on port or not

**GMRP Agent Enable**

Configuration options: Enable/Disable

Default configuration: Disable

Function: Enable GMRP agent function on port or not

**Last PDU Origin**

Function: Source MAC address of the protocol packet received last by the port.



**Caution:**

- Agent port cannot propagate agent entry.
- The premise of enabling GMRP agent function on port is to enable GMRP function on port.

3. Add a GMRP agent entry, as shown below.

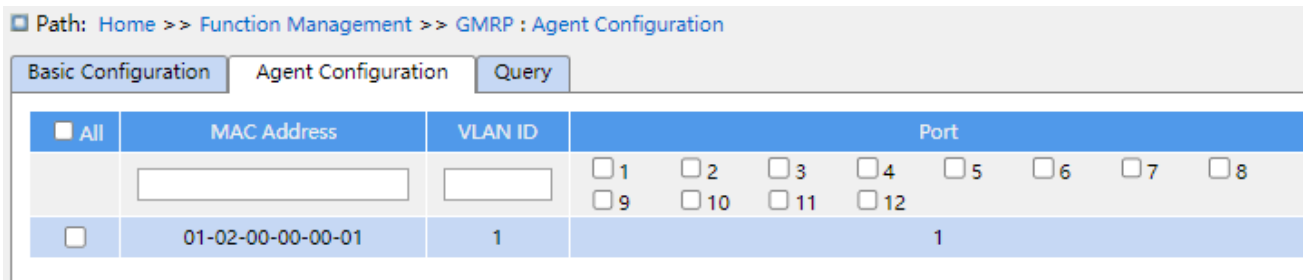

Figure 209 GMRP Agent Entry Configuration

**MAC address**

Format: HH-HH-HH-HH-HH-HH (H is a hexadecimal number)

Function: Configure the MAC address of multicast group. The lowest bit of the first byte is 1.

**VLAN ID**

Configuration options: all created VLAN numbers

Function: Configure the VLAN ID for the GMRP agent entry.

Description: GMRP agent entry can only be forwarded from the propagation port with the VLAN ID same as this entry's VLAN ID.

**Port**

Configuration options: all configured agent ports

4. View GMRP configuration, as shown below.

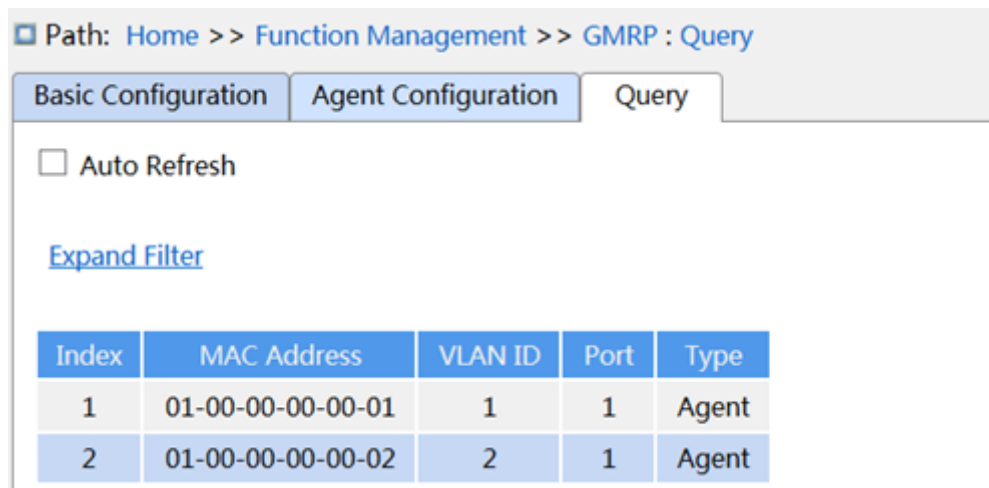

Figure 210 View GMRP configuration information

**7.13.5 Typical Configuration Example**

As shown below, Switch A and Switch B are connected by port 2. Port 1 of Switch A is set to an agent port and generates two multicast entries:

MAC address: 01-00-00-00-00-01, VLAN: 1

MAC address: 01-00-00-00-00-02, VLAN: 2

After configuring different VLAN attributes on ports, observe the dynamic registration between switches and multicast information update.

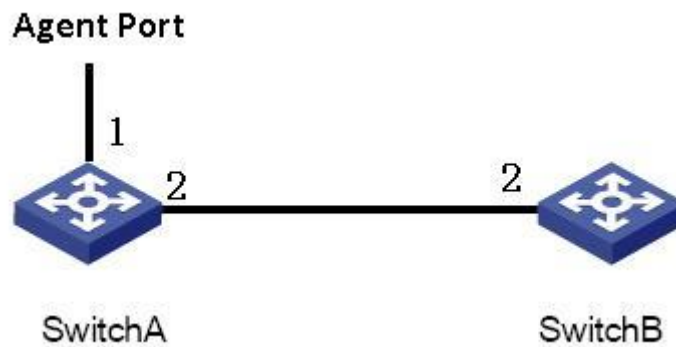

Figure 211 GMRP Networking

**Configuration on Switch A:**

1. Enable global GMRP function in switch A; set timer to the default value, as shown in Figure 207.
2. Enable GMRP function and agent function in port 1; enable only GMRP function in port 2; as shown in Figure 208.
3. Configure agent multicast entry. Set <MAC address, VLAN ID, Member port> to <01-00-00-00-00-01, 1, 1> and <01-00-00-00-00-02, 2, 1>, as shown in Figure 209.

**Configuration on Switch B:**

4. Enable global GMRP function in switch B; set timer to the default value, as shown in Figure 207.
5. Enable GMRP function in port 2; set the timers to default values, as shown in Figure 208.

Table 10 lists the dynamically learned GMRP multicast entries in Switch B.

Table 10 Dynamic Multicast Entries

Attribute of Port 2 on Switch A	Attribute of Port 2 on Switch B	Multicast Entries Received on Switch B
Access VID=1	Access VID=1	MAC: 01-00-00-00-00-01 VLAN ID: 1 Member port: 2

Access VID=2	Access VID= 2	MAC: 01-00-00-00-00-02 VLAN ID: 2 Member port: 2
Access VID= 1	Access VID= 2	MAC: 01-00-00-00-00-01 VLAN ID: 2 Member port: 2

## 7.14 Route configuration

### 7.14.1 Routing Table

#### 7.14.1.1 Introduction

Static routes are manually configured. If a network's topology is simple, you only need to configure static routes for the network to work properly. Static routes are easy to configure and stable. They can be used to achieve load balancing and route backup, preventing illegitimate route changes. The disadvantage of using static routes is that they cannot adapt to network topology changes. If a fault or a topological change occurs in the network, the relevant routes will be unreachable and the network breaks. When this happens, the network administrator must modify the static routes manually.

#### 7.14.1.2 Web Configuration

1. Static routing configuration, as shown below.

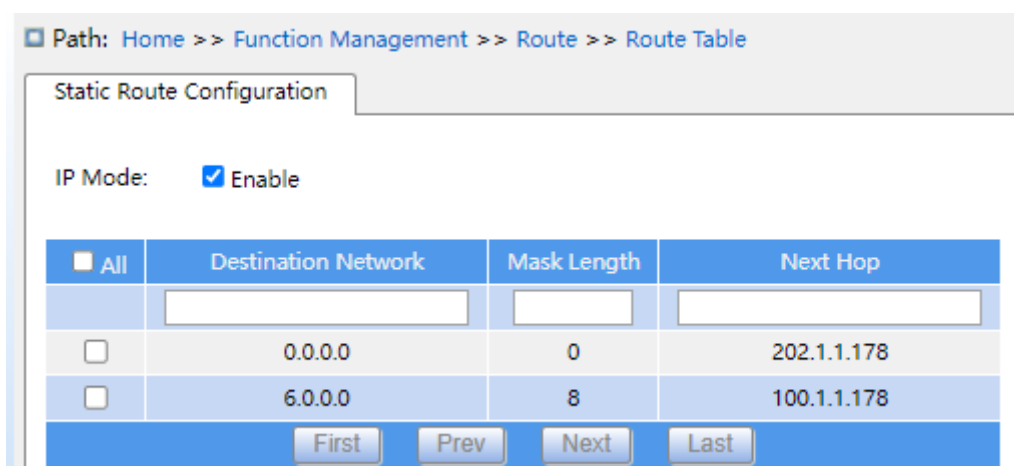

Figure 212 Static routing configuration

**IP Mode**

Configuration options: Enable/disable

Default configuration: For Layer 3 devices, the default is enabled. For Layer 2 devices, the default is not enabled.

Function: Enable or disable IP mode.

**Destination Network**

Configuration format: A.B.C.D

Function: configure the target network address in the static route table.

**Mask Length**

Function: a subnet mask is a 32-bit number, consisting of a sequence "1" and a sequence "0". "1" corresponds to the network number field and the subnet number field, while "0" corresponds to the host number field. The mask length is the number of 1 in the mask.

**Next Hop**

Configuration format: A.B.C.D

Function: Configure the next hop IP address.

**7.14.1.3 Typical Configuration Example**

As shown below, the network masks of all Layer-3 switches and PCs on the network are 255.255.255.0. It is required to configure static routes to enable any of the hosts to communicate with each other.

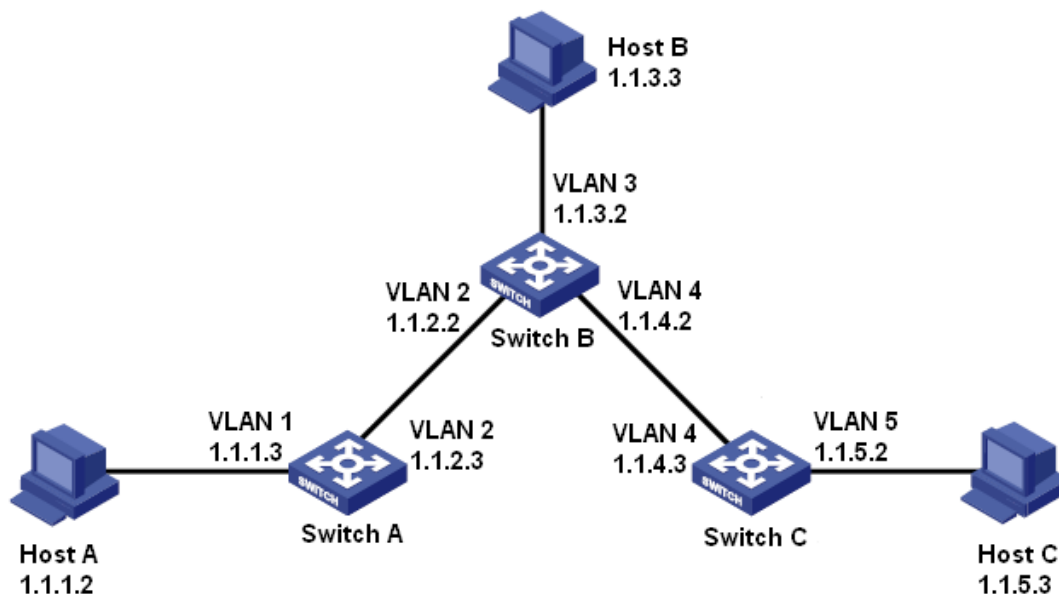

Figure 213 Example for Configuring Static Routes

#### Configuration on Switch A:

1. Set IP addresses for VLAN interfaces.

2. Configure a static route with the following parameters:

Destination IP address: 1.1.3.0; destination network mask: 255.255.255.0; default gateway: 1.1.2.2; priority: 1, as shown in Figure 212.

Destination IP address: 1.1.5.0; destination network mask: 255.255.255.0; default gateway: 1.1.2.2; priority: 1, as shown in Figure 212.

#### Configuration on Switch B:

3. Set IP addresses for VLAN interfaces.

4. Configure a static route with the following parameters:

Destination IP address: 1.1.1.0; destination network mask: 255.255.255.0; default gateway: 1.1.2.3; priority: 1, as shown in Figure 212.

Destination IP address: 1.1.5.0; destination network mask: 255.255.255.0; default gateway: 1.1.4.3; priority: 1, as shown in Figure 212.

#### Configuration on Switch C:

5. Set IP addresses for VLAN interfaces.

6. Configure a static route with the following parameters:



Destination IP address: 0.0.0.0; destination network mask: 0.0.0.0; default gateway: 1.1.4.2; priority: 1, as shown in Figure 212.

7. Configure the default gateways for host A, host B, and host C as 1.1.1.3, 1.1.3.2, and 1.1.5.2 respectively.

## 7.15 QoS Configuration

### 7.15.1 Introduction

Quality of Service (QoS) enables differentiated services based on different requirements under limited bandwidths by means of traffic control and resource allocation on IP networks. QoS tries to satisfy the transmission of different services to reduce network congestion and minimize congestion's impact on the services of high priority.

Traffic classification, traffic policing, traffic shaping, congestion management, and congestion avoidance are the main concepts of QoS deployment. They mainly complete the following functions:

**Traffic classification:** identifies an object based on certain matching rules. It is the basis and prerequisite of QoS.

**Traffic policing:** supervises the traffic rate of packets that are transmitted to a device. When the traffic rate exceeds the specified traffic rate, the device adopts restriction or penalty measures to protect network resources against damage. Traffic policing is classified into port-based traffic policing and queue-based traffic policing.

**Traffic shaping:** proactively adjusts traffic output rate. It aims at adapting traffic to available network resources of a downstream device to prevent unnecessary packet discarding and congestion. Traffic shaping is classified into port-based traffic shaping and queue-based traffic shaping.

**Congestion management:** This is mandatory for solving resource competition. Congestion management caches packets in queues and determines the sequence of packet forwarding based on a certain scheduling algorithm, achieving preferential forwarding for key services.

**Congestion avoidance:** Excessive congestion may result in damage on network resources.

Congestion avoidance monitors the use of network resources. When detecting increasing congestion, the function adopts proactive packet discarding and tunes traffic volume to solve the overload.

Traffic policing, traffic shaping, congestion management, and congestion avoidance control the network traffic and allocated resources from different aspects. They are the specific embodiment of QoS. For example, the switch supervises packets that are transmitted to a network based on the committed rate. It conducts shaping on the packets before the packets leave the switch. It conducts queue scheduling management in the case of congestion, and adopts congestion avoidance measures when the congestion is intensifying.

### 7.15.2 Principle

Each port of this series switches supports 8 cache queues, from 0 to 7 in priority ascending order.

When a frame reaches the port, the switch determines the queue for the frame according to the frame information and port. This series switches support traffic classification in the following queue mapping modes: port, 802.1Q header information, differentiated services code point (DSCP), and QoS control list (QCL), with the priority in ascending order.

When forwarding data, a port uses a scheduling mode to schedule the data in 8 queues and the bandwidth of each queue. This series switches support two scheduling modes: 6 Queues Weighted and SP (Strict Priority) .

WRR (Weighted Round Robin) schedules data flows based on weight ratio. Queues obtain their bandwidths based on their weight ratio. WRR prioritizes high-weight ratio queues. More bandwidths are allocated to queues with higher weight ratio.

SP mode forwards high-priority packets preferentially. It is mainly used for transmitting sensitive signals. If a frame enters the high-priority queue, the switch stops scheduling the low-priority queues and starts to process the data of the high-priority queue. When the high-priority queue contains no data, the switch starts to process the data of the queue with lower priority.

6 Queues Weighted indicates that queue 6 and queue 7 use the Strict Priority scheduling mode, and queue 0 ~ queue 5 use the WRR scheduling mode. Data in queue 7 is processed

prior to data in queue 6. When both queue 7 and queue 6 are empty, data in queue 0 ~ queue 5 is scheduled based on the weight ratio.

### 7.15.3 Web Page configuration

1. Configure 802.1p remarking mode as Mapped, as shown below.

Path: Home >> Function Management >> QoS >> Port Classification : Global Configuration

Global Configuration		Port Classification	
PCP	DEI	QoS	DPL
*	*	* ▼	* ▼
0	0	1 ▼	0 ▼
0	1	1 ▼	1 ▼
1	0	0 ▼	0 ▼
1	1	0 ▼	1 ▼
2	0	2 ▼	0 ▼
2	1	2 ▼	1 ▼
3	0	3 ▼	0 ▼
3	1	3 ▼	1 ▼
4	0	4 ▼	0 ▼
4	1	4 ▼	1 ▼
5	0	5 ▼	0 ▼
5	1	5 ▼	1 ▼
6	0	6 ▼	0 ▼
6	1	6 ▼	1 ▼
7	0	7 ▼	0 ▼
7	1	7 ▼	1 ▼

Figure 214 Configure Mapped Remarking mode



**Caution:**

The queue mapping mode based on 802.1Q header information is only suitable for received messages is tag.

**( PCP, DEI) to (QoS class, DP level) mapping**

Configuration range: 0~7 (QoS type) 0~1 (DP level)

Default configuration: PCP value 0, 1, 2, 3, 4, 5, 6, 7 map to QoS class 1, 0, 2, 3, 4, 5, 6, 7;

DEI value 0, 1 map to DP level 0, 1.

Function: Configure (PCP, DEI) to (CoS, DPL) mapping according to PCP and DEI value in the message.

Description: The QoS class is equal to the CoS value, which determines the storage queue of the message, corresponding to the queue 0 - 7 in turn. When a message enters the switch, the switch assigns CoS and DPL values to the message. If the message type is tag and enable tag class, the CoS and DPL values of the message are the mapping value from (PCP, DEI) to (CoS, DPL) .

2. Enable port hierarchy mode, as shown below

Path: Home >> Function Management >> QoS >> Port Classification : Port Classification

Port	Ingress		
	CoS	Tag Class	DSCP Based
*	* ▾	<input type="checkbox"/>	<input type="checkbox"/>
1	2 ▾	<input type="checkbox"/>	<input type="checkbox"/>
2	0 ▾	<input checked="" type="checkbox"/>	<input type="checkbox"/>
3	0 ▾	<input type="checkbox"/>	<input checked="" type="checkbox"/>
4	0 ▾	<input type="checkbox"/>	<input type="checkbox"/>
5	0 ▾	<input type="checkbox"/>	<input checked="" type="checkbox"/>
6	0 ▾	<input type="checkbox"/>	<input type="checkbox"/>
7	0 ▾	<input type="checkbox"/>	<input type="checkbox"/>
8	0 ▾	<input type="checkbox"/>	<input type="checkbox"/>
9	0 ▾	<input type="checkbox"/>	<input type="checkbox"/>
10	0 ▾	<input type="checkbox"/>	<input type="checkbox"/>
11	0 ▾	<input type="checkbox"/>	<input type="checkbox"/>
12	0 ▾	<input type="checkbox"/>	<input type="checkbox"/>

Figure 215 Configuring port hierarchy mode

**DSCP Based**

Configuration options: enable/disable

Default configuration: do not enable

Function: Enables or disables the DSCP-based queue mapping mode, which has a higher priority than the 802.1Q header-based queue mapping mode.

**CoS**

Configuration range: 0~7

Default Configuration:0

Function: Configure the default CoS value of the port.

**Tag Class**

Configuration options: enable/disable

Default configuration: disable

Function: Enables or disables queue mapping mode based on 802.1Q header information.

3. The 802.1p re-tagging global configuration screen, shown in Figure 216; this screen shows the mode of re-tagging 802.1p when the port forwards messages. 802.1p re-tagging indicates that the port updates the PCP and DEI values in the message when it forwards the message.

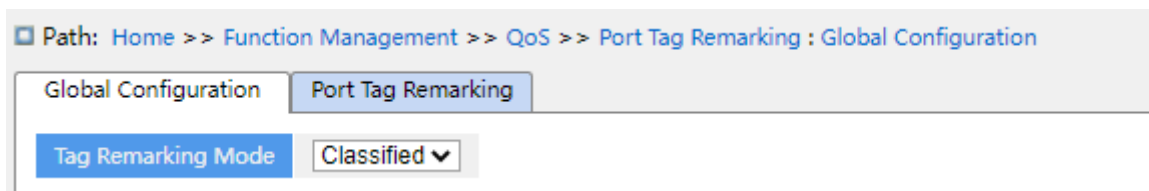

Figure 216 Configure 802.1p retagging mode for global ports



**Caution:**

The 802.1p re-tagging feature is not valid if the outgoing port forwards messages that do not carry a Tag.

- Configure 802.1p retagging mode to Classified as shown in Figure 216.

**Tag Remark Mode**

Configuration options: Classified /Default

Default configuration: Classified

Classified mode: The PCP and DEI values are not updated when the outgoing port forwards the message.

- Configure 802.1p remarking mode as Default, as shown below.

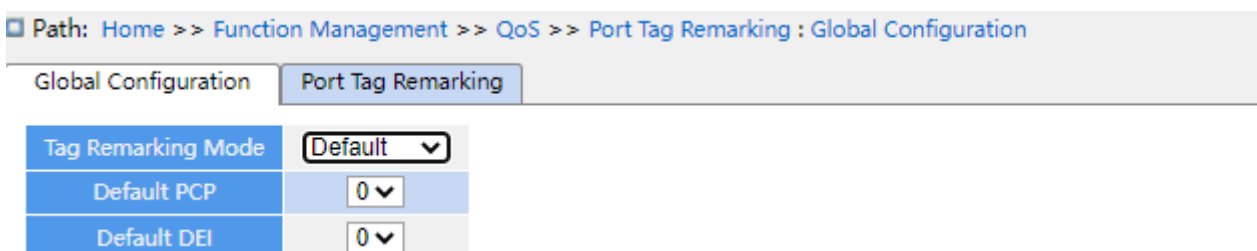

Figure 217 Configure Default Remarking Mode

**Tag Remarking Mode**

Configuration options: Classified/ Default

Default configuration: Classified

Function: configure 802.1p remarking mode. Default mode: When the egressport forwards the message, the PCP and DEI values in the updated message are the default values of the egressport. (configuration as below).

**Default PCP**

Configuration range: 0~7

Default configuration: 0

Function: configure the default PCP value of the egressport.

**Default DEI**

Configuration range: 0~1

Default configuration: 0

Function: configure the default DEI value of the egressport.

4、Configure 802.1p remarking, as shown below.

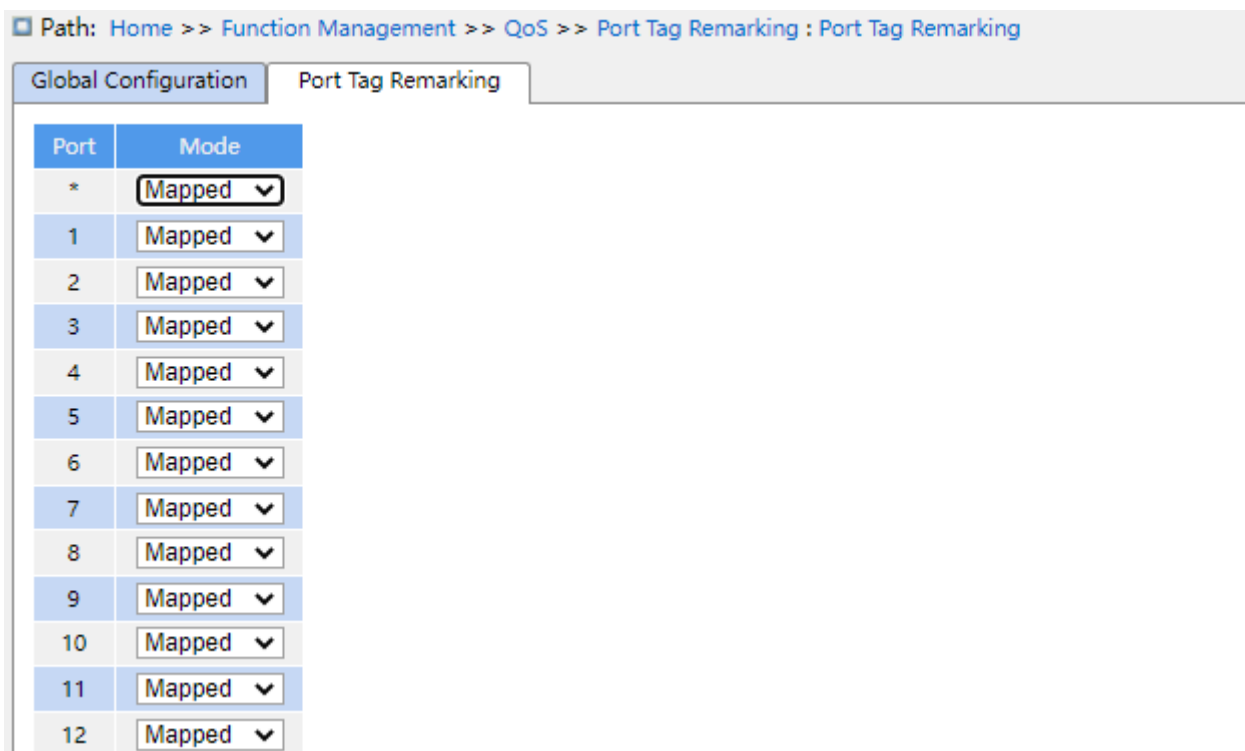

Figure 218 Configure the 802.1p remarking mode of specified port

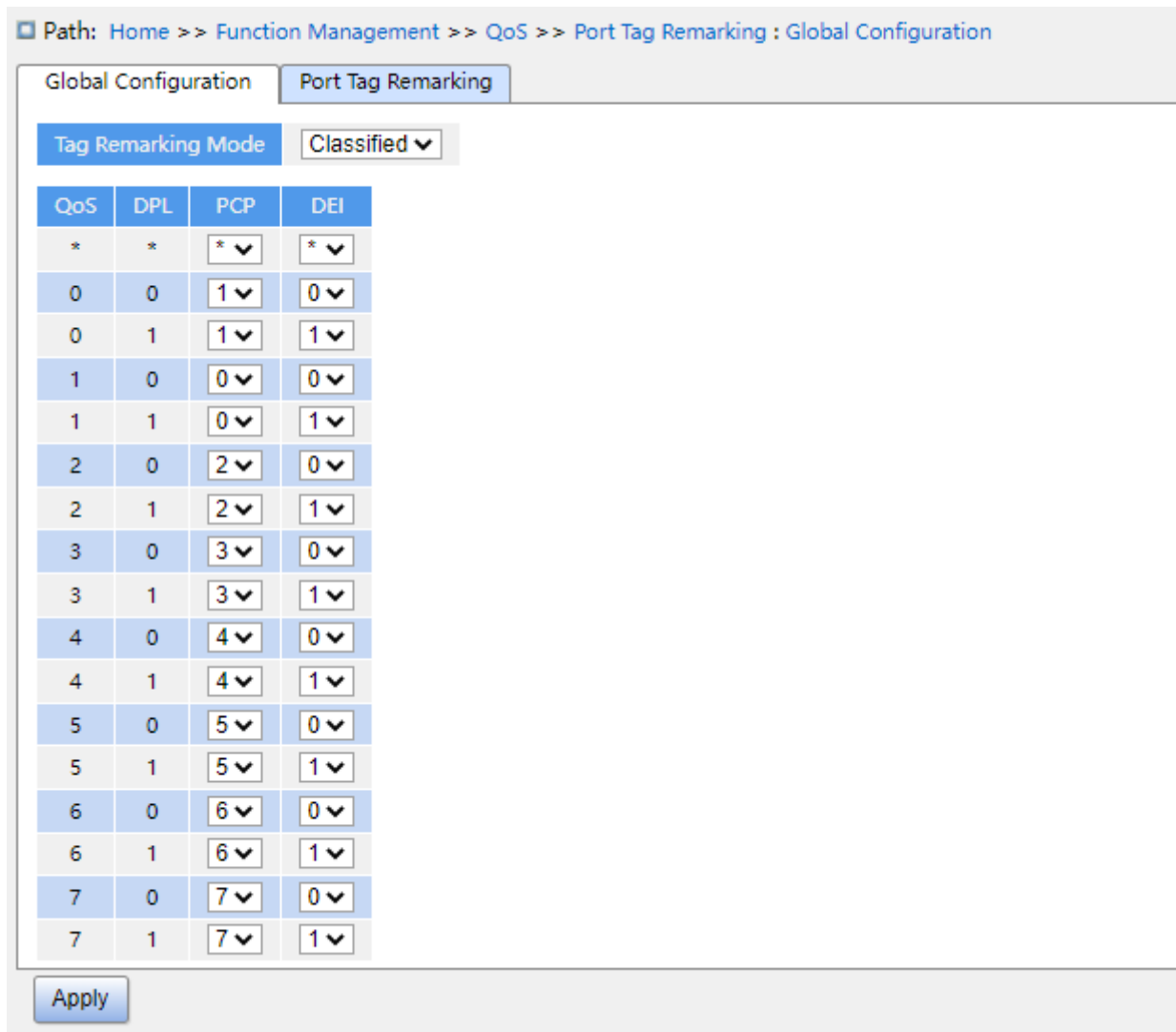

Figure 219 Configure Mapped Remarking mode

### Tag Remarking Mode

Configuration options: Classified/Mapped/Default

Default configuration: Classified

Function: configure 802.1p remarking mode. Mapped mode: When the egressport forwards the message, PCP and DEI values in the updated message are mapping value from (CoS, DPL) to (PCP, DEI) . (mapping configuration as below) .

#### (QoS class, DP level) to (PCP, DEI) mapping

Configuration options: 0~7 (PCP) 0~1 (DEI)

Default configuration: QoS class 0, 1, 2, 3, 4, 5, 6, 7 map to PCP value 1, 0, 2, 3, 4, 5, 6, 7; DP level 0, 1 map to DEI value 0, 1.

Function: according to CoS and DPL value in the message, configure (CoS, DPL) to (PCP,

DEI) mapping.

5.Enable Translate of ingress port, rewrite of egress port, as shown below.

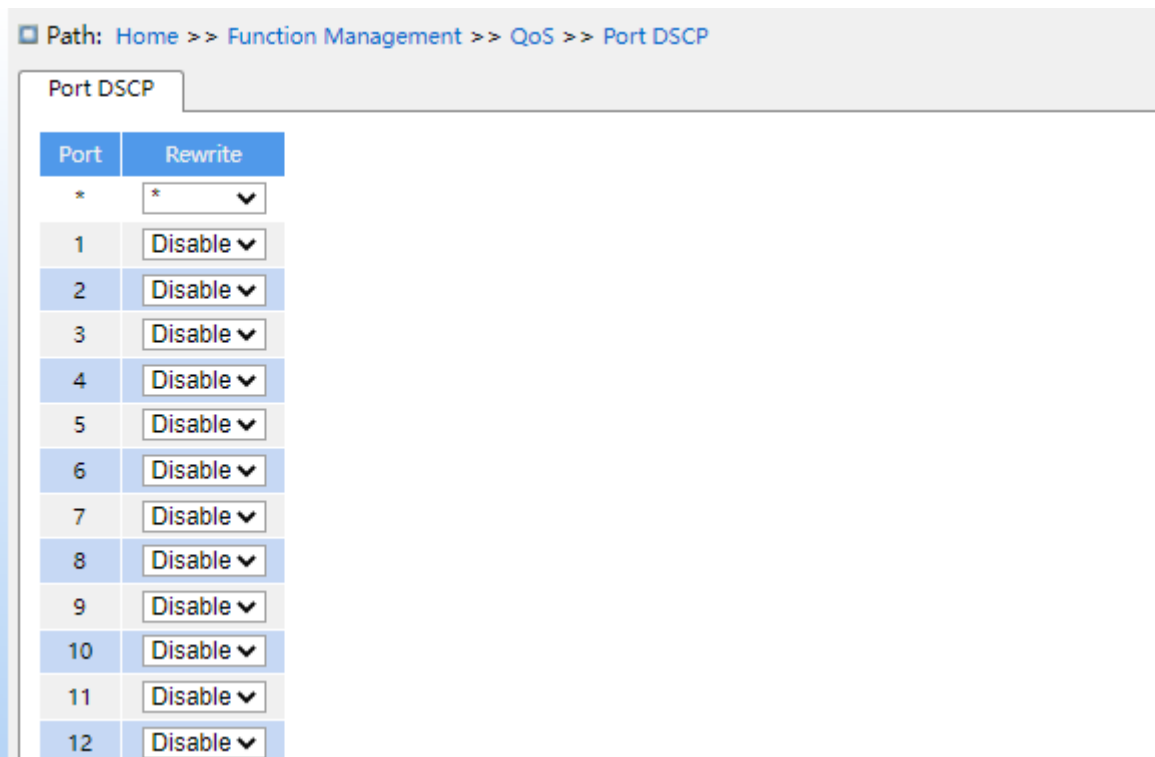

Figure 220 Configure Port DSCP

Rewrite

Configuration options: Disable/enable/remap

Default configuration: Disable

Function: Configure rewrite mode of the DSCP value when the egress port forwards message.

Disable: When egress port forwards the message, the DSCP value in the message is not rewritten;

Enable: When egress port forwards the message, whether to rewrite the DSCP value in the message according to the classify configuration.

Remap: When egress port forwards the message, the DSCP in the message is rewritten according to (DSCP, DPL) to DSCP mapping.

6.Configure queue mapping mode based on DSCP, as shown below.



Path: Home >> Function Management >> QoS >> DSCP-Based QoS

DSCP-Based QoS

DSCP	Trust	CoS	DPL
*	<input type="checkbox"/>	* ▾	* ▾
0	<input type="checkbox"/>	0 ▾	0 ▾
1	<input type="checkbox"/>	0 ▾	0 ▾
2	<input type="checkbox"/>	0 ▾	0 ▾
3	<input type="checkbox"/>	0 ▾	0 ▾
4	<input checked="" type="checkbox"/>	6 ▾	0 ▾
5	<input checked="" type="checkbox"/>	2 ▾	0 ▾
6	<input type="checkbox"/>	0 ▾	0 ▾
7	<input type="checkbox"/>	0 ▾	0 ▾
8	<input type="checkbox"/>	0 ▾	0 ▾
9	<input type="checkbox"/>	0 ▾	0 ▾
10	<input type="checkbox"/>	0 ▾	0 ▾
11	<input type="checkbox"/>	0 ▾	0 ▾
12	<input type="checkbox"/>	0 ▾	0 ▾

Apply

Figure 221 Configure queue mapping mode based on DSCP

**Trust**

Configuration options: Enable/disable

Default configuration: Disable

Function: whether trust the DSCP value.



**Caution:**

The queue mapping mode based on DSCP only applies to the DSCP value of the message received by the port as trust value.

**COS**

Configuration range: 0~7

Default configuration: 0

Function: Configure DSCP to CoS mapping.

Description: The CoS value determines the stored queue of message, CoS value 0 ~ 7 corresponds to the queue 0~7 in turn. When a message with a DSCP value as trust enters

the switch, the switch assigns CoS value to the message according to DSCP to CoS mapping.

---

**Caution:**

When the ingress port enables translate, the switch assigns the CoS value according to the translated DSCP value; otherwise, the switch assigns the CoS value according to the original DSCP value in the message.

---

**DPL**

Configuration range: 0~1

Default configuration: 0

Function: Configure DSCP to DPL mapping

Description: After the message with DSCP value as trust enters the switch, the switch assigns the DPL value to the message according to DSCP to DPL mapping.

7.Configure DSCP translate and rewrite, as shown below.

Path: Home >> Function Management >> QoS >> DSCP Translation

DSCP Translation

DSCP	Remap
*	*
0(BE)	0(BE)
1	1
2	2
3	3
4	4
5	5
6	6
7	7
8(CS1)	8(CS1)
9	9
10(AF11)	10(AF11)
11	11
12(AF12)	12(AF12)
13	13
14(AF13)	14(AF13)
15	15
16(CS2)	16(CS2)
17	17
18(AF21)	18(AF21)
19	19
20(AF22)	20(AF22)
21	21
22(AF23)	22(AF23)
23	23
24(CS3)	24(CS3)

Apply

Figure 222 Configure DSCP translate and rewrite

**Translate**

Configuration range: 0~63

Function: configure translation table of dscp value.



**Caution:**

When the ingress port enable “translate” , the selected value is the translated value ;

Otherwise, the selected DSCP value is the original DHCP value in the message.

### Remap DP0

Configuration range: 0~63

Function: Configure (DSCP, DPL) to DSCP mapping.

8、Configure port queue scheduler mode, as shown in Figure 223 and Figure 224.

Path: Home >> Function Management >> QoS >> Port Scheduler : Mode

Mode Weight Configuration

Port	Mode
*	*
1	8Queues Weighted
2	8Queues Weighted
3	8Queues Weighted
4	8Queues Weighted
5	8Queues Weighted
6	8Queues Weighted
7	8Queues Weighted
8	8Queues Weighted
9	8Queues Weighted
10	8Queues Weighted
11	8Queues Weighted
12	8Queues Weighted

Figure 223 Configure port queue scheduler mode

Path: Home >> Function Management >> QoS >> Port Scheduler : Weight Configuration

Mode Weight Configuration

Port	Weight							
	Queue0	Queue1	Queue2	Queue3	Queue4	Queue5	Queue6	Queue7
1	1	1	2	2	3	3	4	4
2	1	1	2	2	3	3	4	4
3	1	1	2	2	3	3	4	4
4	1	1	2	2	3	3	4	4
5	1	1	2	2	3	3	4	4
6	20	40	40	20	20	20	20	20
7	1	1	2	2	3	3	4	4
8	1	1	2	2	3	3	4	4

Figure 224 Configure port weighting of scheduler

**Scheduler Mode**

Configuration options: Strict Priority /2-8 queues weighted

Default configuration: Strict Priority

Function: Configure port queue scheduler mode.

**Weight**

Configuration range: 1~100

Default configuration: 17

Function: Configure queue weight.

9.Configure Port Shaping, as shown below.

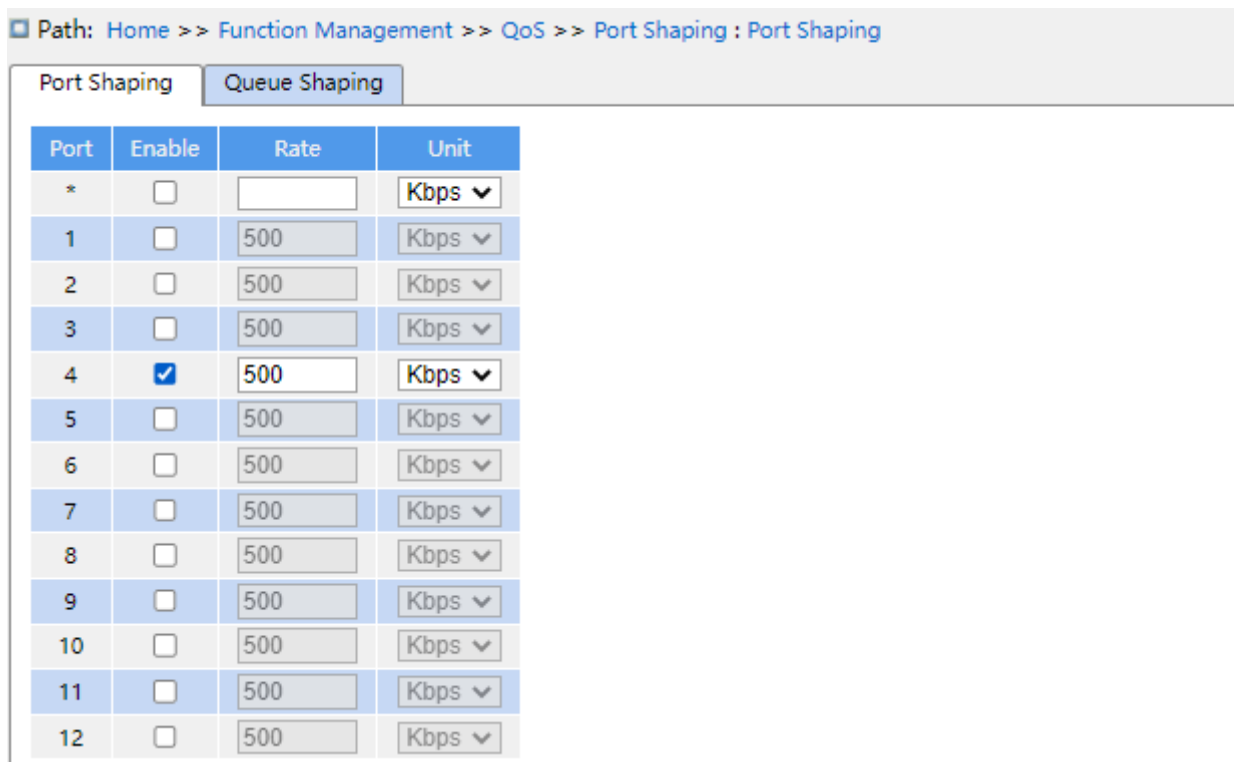

Figure 225 Configure Port Shaping

**Enable**

Configuration options: Enable/disable

Default configuration: disable

Function: whether enable port shaping. Port traffic shaping through the port rate limit to achieve.

**Rate, Unit**

Configuration range:16~1000000kbps/ 1~1000Mbps

Function: Limit the rate of the amount of frame transmitted by port, and drop the frame exceed the limited value.

10、Configure Queue shaping, as shown below.

Path: Home >> Function Management >> QoS >> Port Shaping : Queue Shaping

Port	Queue0			Queue1			Queue2			Queue3			Queue4			Queue5			Queue6			Queue7		
	Enable	Rate	Unit	Enable	Rate	Unit	Enable	Rate	Unit	Enable	Rate	Unit	Enable	Rate	Unit	Enable	Rate	Unit	Enable	Rate	Unit	Enable	Rate	Unit
*	<input type="checkbox"/>		Kbps	<input type="checkbox"/>		Kbps	<input type="checkbox"/>		Kbps	<input type="checkbox"/>		Kbps	<input type="checkbox"/>		Kbps	<input type="checkbox"/>		Kbps	<input type="checkbox"/>		Kbps	<input type="checkbox"/>		Kbps
1	<input checked="" type="checkbox"/>	500	Kbps	<input checked="" type="checkbox"/>	500	Kbps	<input type="checkbox"/>	500	Kbps	<input type="checkbox"/>	500	Kbps	<input type="checkbox"/>	500	Kbps	<input type="checkbox"/>	500	Kbps	<input type="checkbox"/>	500	Kbps	<input type="checkbox"/>	500	Kbps
2	<input type="checkbox"/>	500	Kbps	<input type="checkbox"/>	500	Kbps	<input type="checkbox"/>	500	Kbps	<input type="checkbox"/>	500	Kbps	<input type="checkbox"/>	500	Kbps	<input type="checkbox"/>	500	Kbps	<input type="checkbox"/>	500	Kbps	<input type="checkbox"/>	500	Kbps
3	<input type="checkbox"/>	500	Kbps	<input type="checkbox"/>	500	Kbps	<input type="checkbox"/>	500	Kbps	<input type="checkbox"/>	500	Kbps	<input type="checkbox"/>	500	Kbps	<input type="checkbox"/>	500	Kbps	<input type="checkbox"/>	500	Kbps	<input type="checkbox"/>	500	Kbps
4	<input type="checkbox"/>	500	Kbps	<input type="checkbox"/>	500	Kbps	<input type="checkbox"/>	500	Kbps	<input type="checkbox"/>	500	Kbps	<input type="checkbox"/>	500	Kbps	<input type="checkbox"/>	500	Kbps	<input type="checkbox"/>	500	Kbps	<input type="checkbox"/>	500	Kbps
5	<input type="checkbox"/>	500	Kbps	<input type="checkbox"/>	500	Kbps	<input type="checkbox"/>	500	Kbps	<input type="checkbox"/>	500	Kbps	<input type="checkbox"/>	500	Kbps	<input type="checkbox"/>	500	Kbps	<input type="checkbox"/>	500	Kbps	<input type="checkbox"/>	500	Kbps
6	<input type="checkbox"/>	500	Kbps	<input type="checkbox"/>	500	Kbps	<input type="checkbox"/>	500	Kbps	<input type="checkbox"/>	500	Kbps	<input type="checkbox"/>	500	Kbps	<input type="checkbox"/>	500	Kbps	<input type="checkbox"/>	500	Kbps	<input type="checkbox"/>	500	Kbps
7	<input type="checkbox"/>	500	Kbps	<input type="checkbox"/>	500	Kbps	<input type="checkbox"/>	500	Kbps	<input type="checkbox"/>	500	Kbps	<input type="checkbox"/>	500	Kbps	<input type="checkbox"/>	500	Kbps	<input type="checkbox"/>	500	Kbps	<input type="checkbox"/>	500	Kbps
8	<input type="checkbox"/>	500	Kbps	<input type="checkbox"/>	500	Kbps	<input type="checkbox"/>	500	Kbps	<input type="checkbox"/>	500	Kbps	<input type="checkbox"/>	500	Kbps	<input type="checkbox"/>	500	Kbps	<input type="checkbox"/>	500	Kbps	<input type="checkbox"/>	500	Kbps
9	<input type="checkbox"/>	500	Kbps	<input type="checkbox"/>	500	Kbps	<input type="checkbox"/>	500	Kbps	<input type="checkbox"/>	500	Kbps	<input type="checkbox"/>	500	Kbps	<input type="checkbox"/>	500	Kbps	<input type="checkbox"/>	500	Kbps	<input type="checkbox"/>	500	Kbps
10	<input type="checkbox"/>	500	Kbps	<input type="checkbox"/>	500	Kbps	<input type="checkbox"/>	500	Kbps	<input type="checkbox"/>	500	Kbps	<input type="checkbox"/>	500	Kbps	<input type="checkbox"/>	500	Kbps	<input type="checkbox"/>	500	Kbps	<input type="checkbox"/>	500	Kbps
11	<input type="checkbox"/>	500	Kbps	<input type="checkbox"/>	500	Kbps	<input type="checkbox"/>	500	Kbps	<input type="checkbox"/>	500	Kbps	<input type="checkbox"/>	500	Kbps	<input type="checkbox"/>	500	Kbps	<input type="checkbox"/>	500	Kbps	<input type="checkbox"/>	500	Kbps
12	<input type="checkbox"/>	500	Kbps	<input type="checkbox"/>	500	Kbps	<input type="checkbox"/>	500	Kbps	<input type="checkbox"/>	500	Kbps	<input type="checkbox"/>	500	Kbps	<input type="checkbox"/>	500	Kbps	<input type="checkbox"/>	500	Kbps	<input type="checkbox"/>	500	Kbps

Apply

Figure 226 Configure Queue shaping

**Enable**

Configuration options: Enable/disable

Default configuration: disable

Function: whether enable queue shaping.

**Rate, Unit**

Configuration range: 16~1000000kbps/ 1~1000Mbps

Default configuration: 500kbps

Function: Limit the rate of the amount of frame transmitted by queue on port, and drop the frame exceed the limited value.

**7.15.4 Typical Configuration Example**

As shown in Figure 227, port1~port5 forward packet to port 6. Among them,

The packets received by port1 are Untag, and the packets entering port 1 are mapped to queue 2.

The PCP value of port 2 received packet is 0, DEI value is 1, and the packets entering port 2 are mapped to queue 3.

The DSCP value of port 3 received packet is 4, and the packets entering port 3 are mapped to queue 6.

Port4 is enabled to test port traffic shaping, and since traffic shaping takes effect in the outgoing port direction, the configuration is sent down to Port6

The DSCP value of port 5 received packet is 5, and the packets entering port 5 are mapped to queue 2.

Port 6 adopts SP+WRR scheduling mode.

**Configuration process:**

1. Set the CoS value of port 1 is 2, as shown in Figure 215.
2. Enable Tag Class of port 2, and map (PCP=0, DEI=1) to CoS=3, as shown in Figure 214.
3. Enable DSCP Based of port 3 and port 5, as shown in Figure 215.
4. Trust DSCP value 4 and 5, and map DSCP value 4 to queue 6 and DSCP value 5 to queue 2, as shown in Figure 221.
5. Enable port 6 traffic shaping to limit messages sent on port 4 to 500kbps, e.g. Figure 225.
6. Configure port 6 queue scheduling mode to 6 Queues Weighted, queue weight of Q0~Q5 to 20, 40, 40, 20, 20, 20, as shown in Figure 223 and Figure 224.

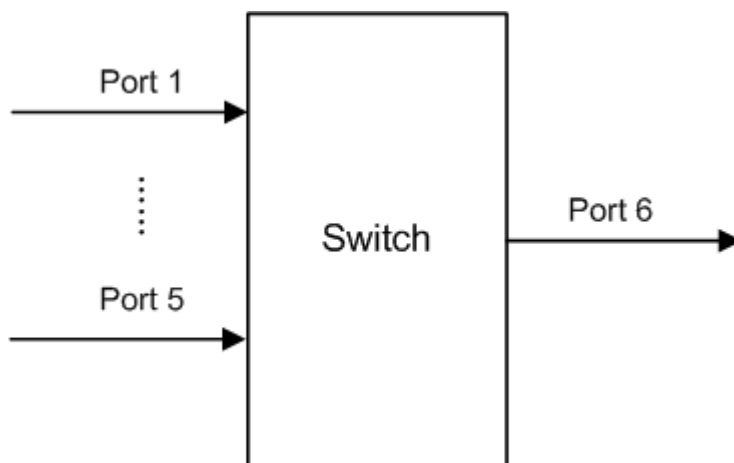

Figure 227 QoS Configuration Example

Port1 and port5 packets enter queue 2, port2 packets enter queue 3, port3 packets enter queue 6, port4 packets enter queue 5.

Queue 6 and queue 7 use the strict priority scheduling mode, and queues 0 through 5 uses the WRR scheduling mode. Data in queue 6 is processed first. When queue 6 is empty, data in queues 0 through 5 is scheduled by weight ratio.

The queue weight are 20, 40, 40, 20, 20, 20. So the bandwidth proportion allocated to the packets in ingress queue 2 is  $40 / (20+40+40+20+20+20) = 25\%$ , that allocated to the packets in ingress queue 3 is  $20 / (20+40+40+20+20+20) = 13\%$ , and that allocated to the packets in

ingress queue 5 is  $20 / (20 + 40 + 40 + 20 + 20 + 20) = 13\%$ . Among them, port 1 and port 5 packets both enter queue 2, so they are forwarded according to the rule of First In, First out (FIFO), but the total bandwidth proportion of port 1 and port 5 must be 25%.



## 8 Loop Detect Configuration

### 8.1 Overview

After loop detect is enabled for the port, loop detect packets would be sent out through the port to decide whether loops exist in the network connected to the port. The CPU send loop detect packets to the port periodically. If any port of the switch receives the loop detect packets, it is determined that the loops exist in the network. Shut down the port that is sending loop detect packets and the port would be linked up automatically after a while and continue detection. The time interval for sending loop detect packets and the port recover time can be configured in the software.

**Note:**

Loop detection and DT-Ring/DRP/RSTP/MSTP are mutually exclusive. A port enabled loop detection cannot be configured as a redundant port; a redundant port cannot be enabled loop detection.

---

### 8.2 Web Configuration

1. Configure the loop detect function of the port, as shown in Figure 228.

Path: Home >> Function Management >> Loop Protection : Loop Protection Configuration

Loop Protection Configuration    Loop Protection Status

**Global Configuration**

Enable Loop Protection    Disable ▾

Transmission Time    5 (1-10)Second(s)

Shutdown Time    180 (0-604800)Second(s)

**Port Configuration**

Port	Enable	Action	Tx Mode
*	<input type="checkbox"/>	<> ▾	<> ▾
1	<input checked="" type="checkbox"/>	Shutdown Port ▾	Enable ▾
2	<input checked="" type="checkbox"/>	Shutdown Port ▾	Enable ▾
3	<input checked="" type="checkbox"/>	Shutdown Port ▾	Enable ▾
4	<input checked="" type="checkbox"/>	Shutdown Port ▾	Enable ▾
5	<input checked="" type="checkbox"/>	Shutdown Port ▾	Enable ▾
6	<input checked="" type="checkbox"/>	Shutdown Port ▾	Enable ▾
7	<input checked="" type="checkbox"/>	Shutdown Port ▾	Enable ▾
8	<input checked="" type="checkbox"/>	Shutdown Port ▾	Enable ▾
9	<input checked="" type="checkbox"/>	Shutdown Port ▾	Enable ▾
10	<input checked="" type="checkbox"/>	Shutdown Port ▾	Enable ▾
11	<input checked="" type="checkbox"/>	Shutdown Port ▾	Enable ▾
12	<input checked="" type="checkbox"/>	Shutdown Port ▾	Enable ▾

Apply

Figure 228 Enable the Loop Detect Function of the Port

**Enable Loop Protection**

Options: Enable/Disable

Default: Disable

Function: Enable or disable the global loop detect function of the port.

**Transmission Time**

Range: 1~10s

Default: 5s

Function: Configure the time interval for sending loop detect packets.

**Shutdown Time**

Range: 0~604800s

Default: 180s

Function: Configure the port recover time, 0 indicates the port cannot be linked up automatically until restarting device.

**Enable**

Options: Enable/Disable

Default: Enable

Function: Enable or disable the loop detection function of the port.

**Action**

Option: Shutdown Port/Shutdown Port and Log/Log Only

Default: Shutdown Port

Function: Specify the action to be performed when a port detects that a loop exists.

**Tx Mode**

Options: Enable/Disable

Default: Enable

Function: Whether to send loop detect packets or not.

---

**Caution:**

A port can accurately detect whether a loop exists only after the loop protection is enabled globally, the loop protection and Tx mode are enabled on the port.

---

2. View loop protection status, as shown in Figure 229.

Path: Home >> Function Management >> Loop Protection : Loop Protection Status

Loop Protection Configuration | Loop Protection Status

Auto Refresh

Port	Action	Transmitted	Loops	Status	Loop	Time of Last Loop
1	Shutdown	Enabled	0	Down	--	--
2	Shutdown	Enabled	0	Down	--	--
3	Shutdown	Enabled	0	Down	--	--
4	Shutdown	Enabled	0	Down	--	--
5	Shutdown	Enabled	0	Down	--	--
6	Shutdown	Enabled	0	Down	--	--
7	Shutdown	Enabled	0	Up	--	--
8	Shutdown	Enabled	0	Down	--	--
9	Shutdown	Enabled	0	Down	--	--
10	Shutdown	Enabled	0	Down	--	--
11	Shutdown	Enabled	0	Down	--	--
12	Shutdown	Enabled	0	Down	--	--

Refresh

Figure 229 View Loop Protection Status

### Loop Protection Status

Options: --/Loop

Function: Loop detection status displays whether there are loops in the network when the loop detection function of the port is enabled. Loop indicates there are loops while -- indicated no loop exists.

### 8.3 Typical Configuration Example

Networking Requirements:

Port 3 of the switch is connected to the external network. When there are loops for the network, shut down port 3, as shown in Figure 230.

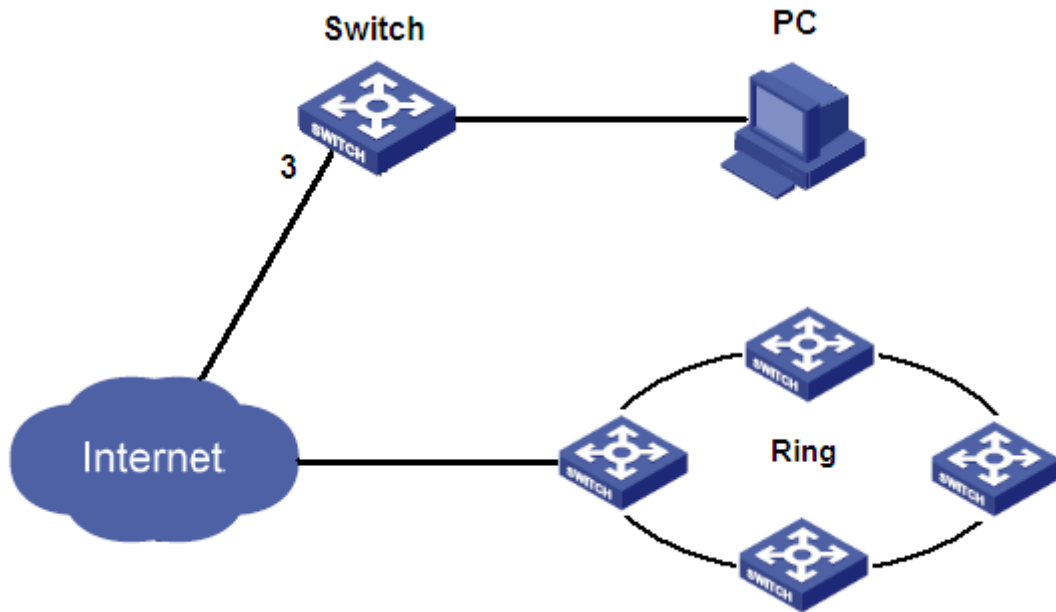

Figure 230 Loop Detect Instance

Specific configuration:

Enable the loop detection on port 3, as shown in Figure 228.

## 9 Diagnosis

### 9.1 Log

#### 9.1.1 Introduction

The log function mainly records system status, fault, debugging, anomaly, and other information. With appropriate configuration, the switch can upload logs into a Syslog-supported server in real time.

Log contains information about alarms, broadcast storm, reboot, memory, and information about users' operations.

#### 9.1.2 Web Configuration

1. Configure system log, as shown below.

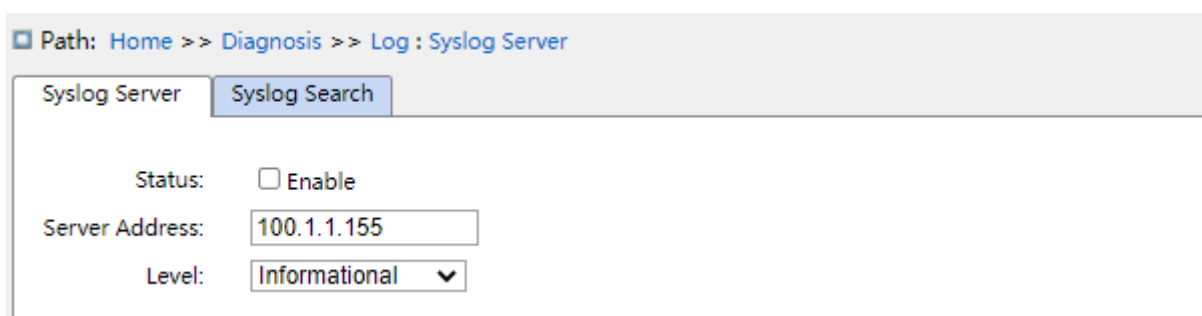

Path: Home >> Diagnosis >> Log : Syslog Server

Syslog Server Syslog Search

Status:  Enable

Server Address: 100.1.1.155

Level: Informational

Figure 231 Configure Syslog Server

#### Status

Configuration options: Enable/disable

Default configuration: Disable

Function: whether enable syslog server.

#### Server address

Configuration format: A.B.C.D

Function: configure IP address of syslog server.

#### Level

Configuration options: Error/Warning/Notice/Information

Default configuration: Information

Function: Select displayed log information level.

2. Syslog search, as shown below.

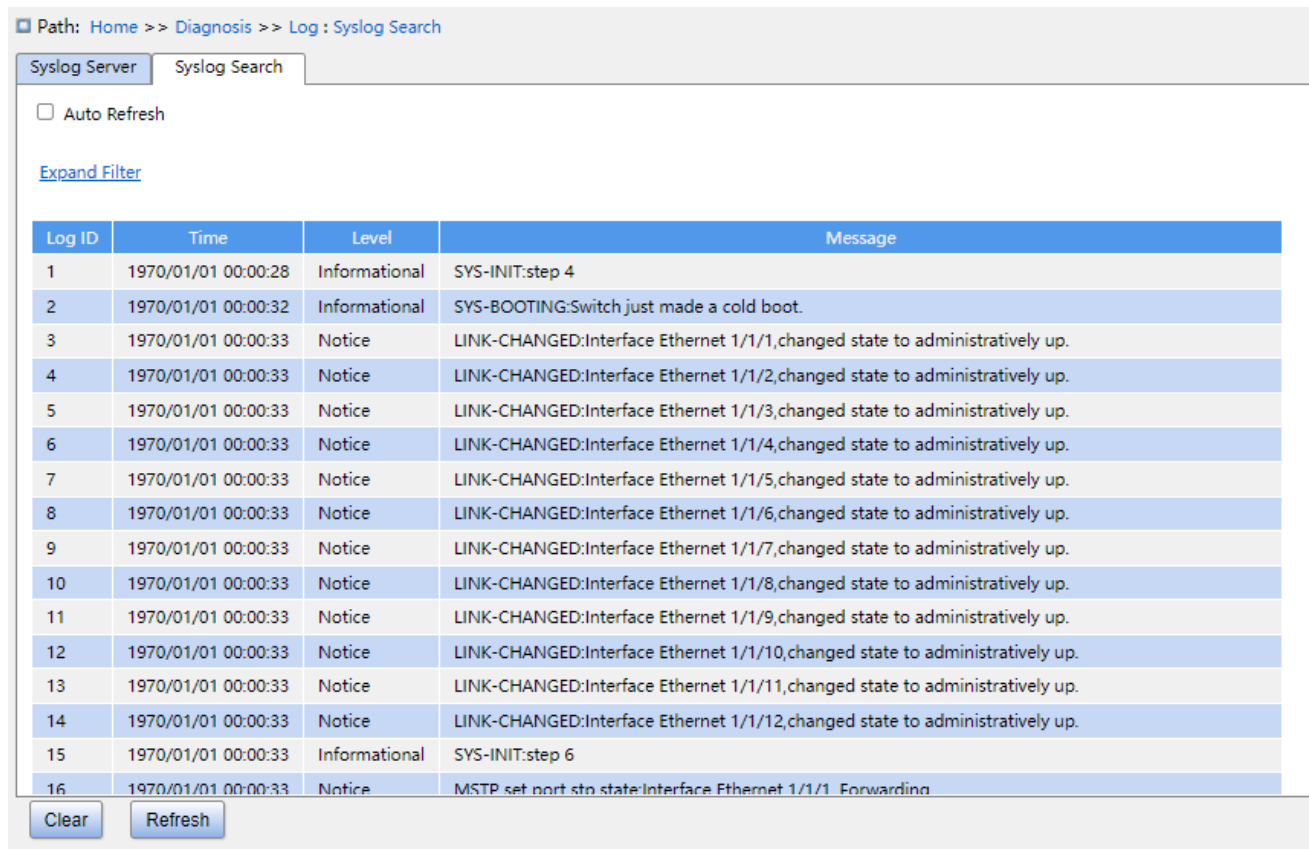

Figure 232 Syslog search

### Auto Refresh

Configuration options: check/uncheck

Default configuration: uncheck

Function: whether enable auto refresh.

### Log ID

Configuration options: \*/>=/\*<=/\*select range

Default configuration: \*

Function: Select filtered Log ID, “\*” is all ID log, “>=” is Filter logs greater than or equal to an ID, “<=” is filter less than or equal to an ID, “select range” enter an ID range logs manually.

### Time

Configuration options: \*/Start/end/select range

Default configuration: \*

Function: Select filtered time range, “\*” is all time log, “Start” is the start time of log, “end” is the end time of log, “select range” enter a time range logs manually.

**Level**

Configuration options: \*/>=/<=/select range

Default configuration: \*

Function: Select filtered level range, “\*” is all level log, “>=” is filter logs greater than or equal to a level, “<=” is filter logs less than or equal to a level, “select range” enter a level range logs manually, the levels includes Error, Warning, Notice, Information.

**Message**

Configuration options: \*/include/not include

Default configuration: \*

Function: Select filtered message, “\*” is all logs, “include”include Logs for some fields, ”not include” do not include logs for some fields.

3. Clear logs, as shown below.

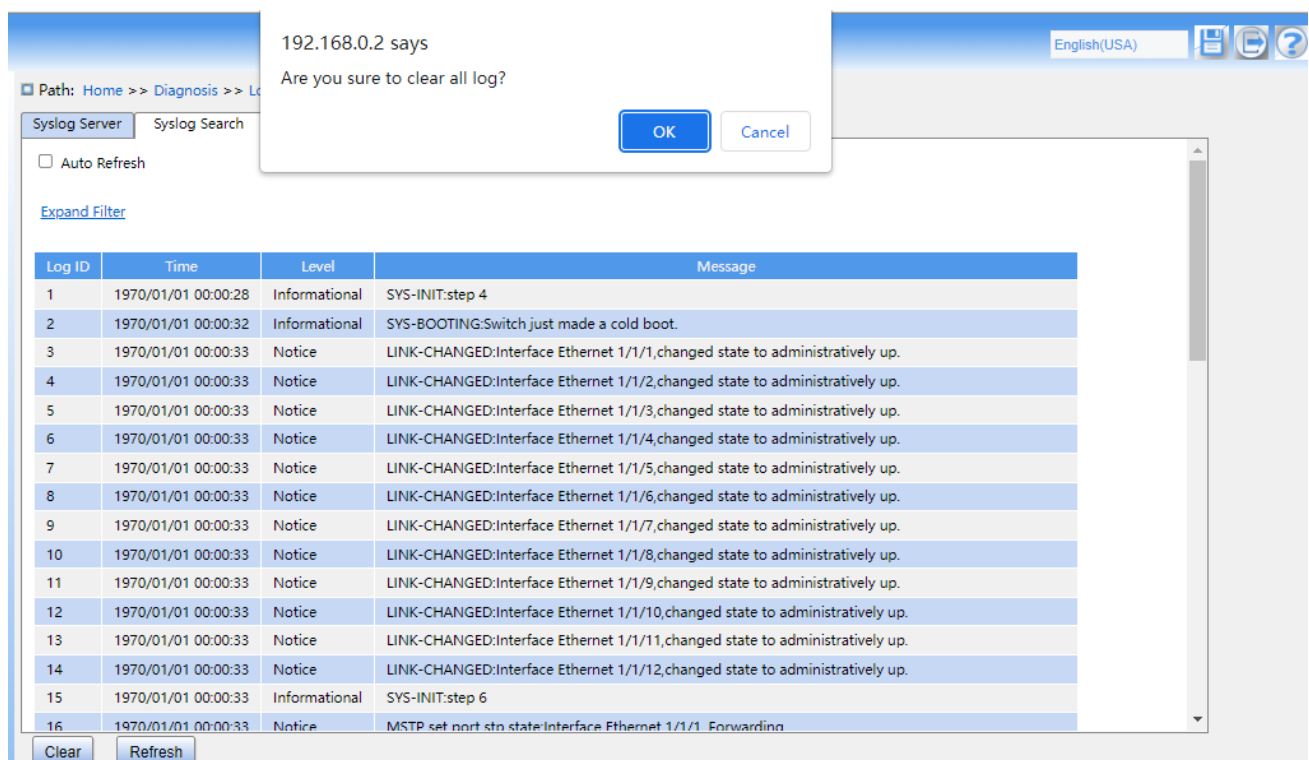

Figure 233 Clear logs

After the query log is finished, click lower left quarter <clear>button, clear logs.



The server of the syslog protocol can choose to install the software supporting syslog server on the PC, such as Tftpd32. The log information can be viewed in real time through syslog server, as shown below.

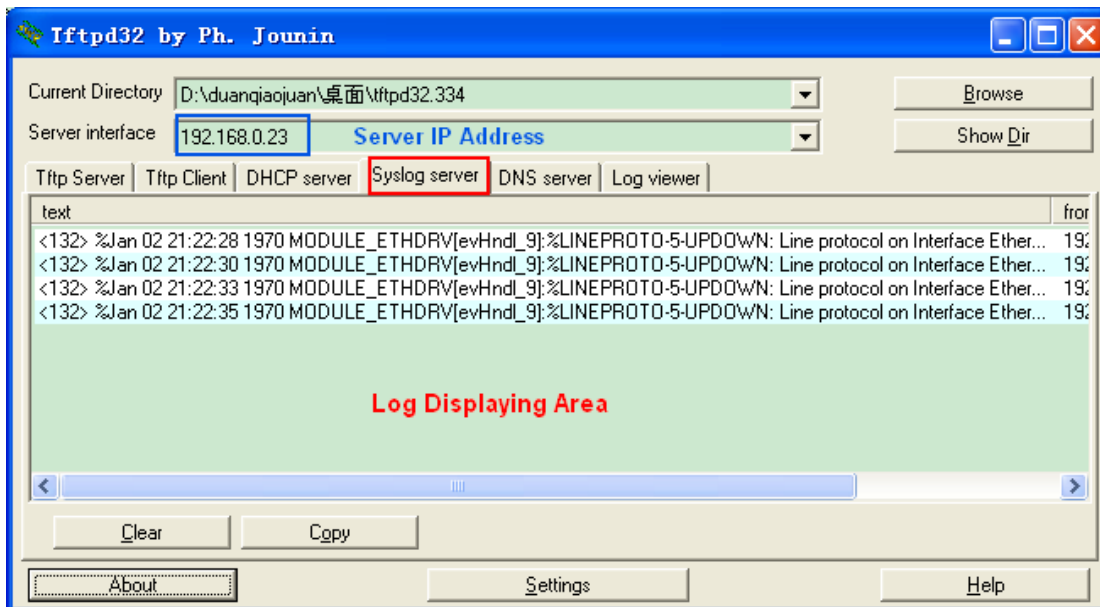

Figure 234 Real-time upload log information

## 9.2 Port Mirror

### 9.2.1 Introduction

With port mirror function, the switch copies all received or transmitted data frames in a port (mirror source port) to another port (mirror destination port). The mirrordestination port is connected to a protocol analyzer or RMON monitor for network monitor, management, and fault diagnosis.

### 9.2.2 Explanation

A switch supports four mirror destination port but multiple source ports.

Multiple source ports can be either in the same VLAN, or in different VLANs. Mirrorsource port and destination port can be in the same VLAN or in different VLANs.

The source port and destination port cannot be the same port.



**Caution:**

The dynamic MAC address learning must be disabled on a destination port.

### 9.2.3 Web Configuration

1. Configure port mirror function, as shown below.

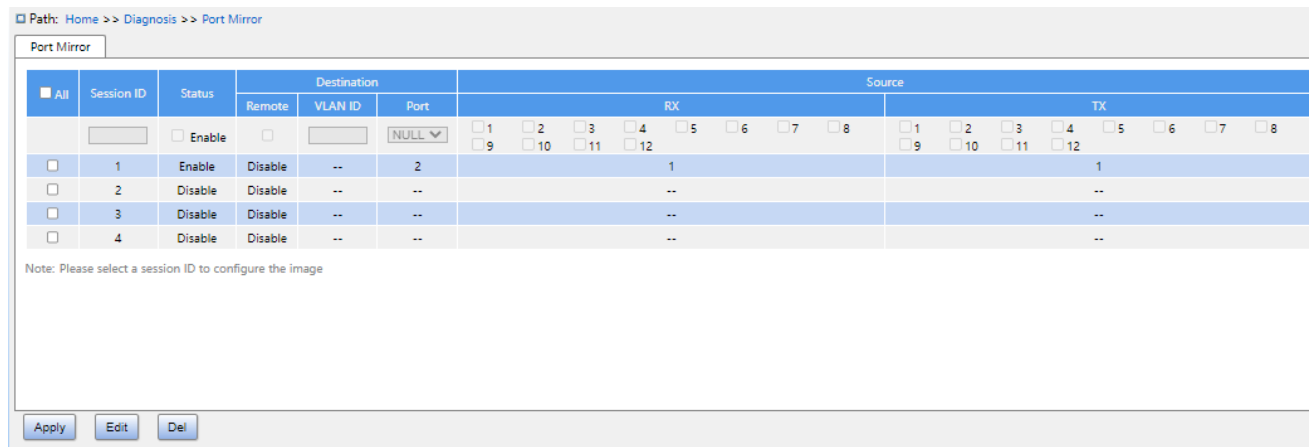

Figure 235 Configure Port Mirror Function

#### ALL

Configuration options: Check/uncheck

Default configuration: Uncheck

Function: Check this mirrored group to edit and modify.

#### Status

Configuration options: Enable/disable

Function: whether enable port mirror.

#### Destination Port

Configuration options: NULL/port number

Default configuration: NULL

Function: Select the mirror destination port , only one mirror destination port .

#### Rx

Configuration options: Enable/disable

Default configuration: Disable

Function: Whether to mirror frames received from the source port.

#### Tx

Configuration options: Enable/disable

Default configuration: Disable

Function: Whether to mirror frames transmitted from the source port.

2. Configure Remote Mirror, as shown below.

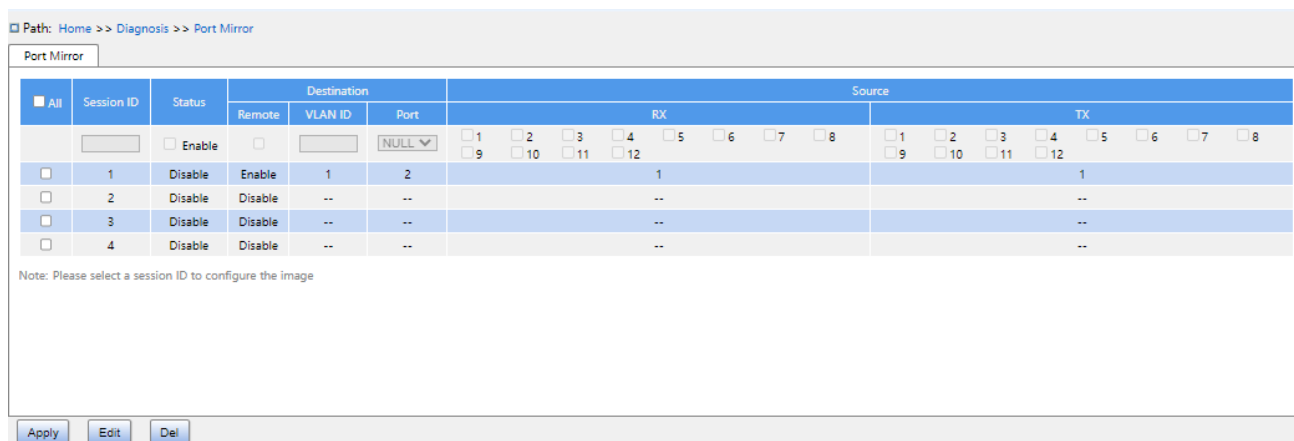

Figure 236 Configure Remote Mirror

**All**

Configuration options: Check/uncheck

Default configuration: Uncheck

Function: Check this mirrored group to edit and modify.

**Status**

Configuration options: Enable/disable

Function: whether enable port mirror.

**Destination Remote**

Configuration options: Enable/disable

Default configuration: Disable

Function: Whether enable destination remote mirror, destination and source remote cannot be enabled at the same time.

**Destination VLAN ID**

Configuration range: 1~4093

Function: Configure VLAN ID of destination remote mirror.

**Destination Port**

Configuration options: NULL/Port number

Default configuration: NULL

Function: When configuring the destination remote mirror, the destination port is used as the reflection port, and when configuring the source remote mirror, the destination port is the

remote mirror destination port.

**Rx**

Configuration options: Enable/disable

Default configuration: Disable

Function: Whether to mirror frames received from the source port.

**Tx**

Configuration options: Enable/disable

Default configuration: Disable

Function: Whether to mirror frames transmitted from the source port.

**9.2.4 Typical Configuration Example**

As shown in Figure 237, the mirror destination port is port 2 and the mirror source port is port 1. Both transmitted and received packets on port 1 are mirrored to port 2.

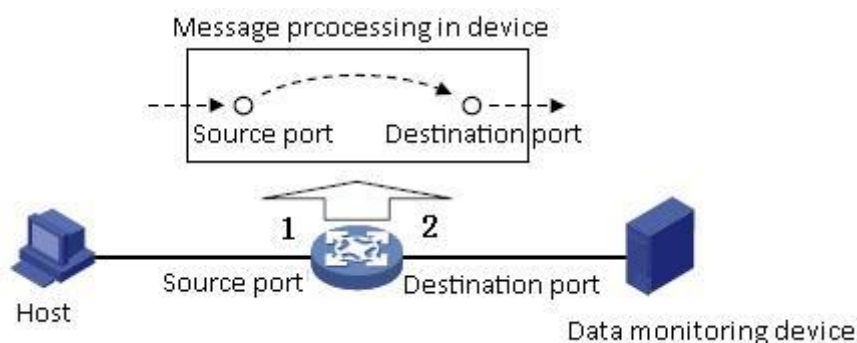

Figure 237 Port Mirror Example

**Configuration process:**

1. Enable port mirror function, as shown in Figure 235.
2. Set port 2 to the mirror destination port, port 1 to the mirror source port and the port mirror mode to both, as shown in Figure 235.

**9.3 LLDP**

**9.3.1 Introduction**

The Link Layer Discovery Protocol (LLDP) provides a standard link layer discovery mechanism. It encapsulates device information such as the capability, management address,

device identifier, and interface identifier in a Link Layer Discovery Protocol Data Unit (LLDPDU), and advertises the LLDPDU to its directly connected neighbors. Upon receiving the LLDPDU, the neighbors save these information to MIB for query and link status check by the NMS.

### 9.3.2 Web Configuration

1. Configure LLDP, as shown below.

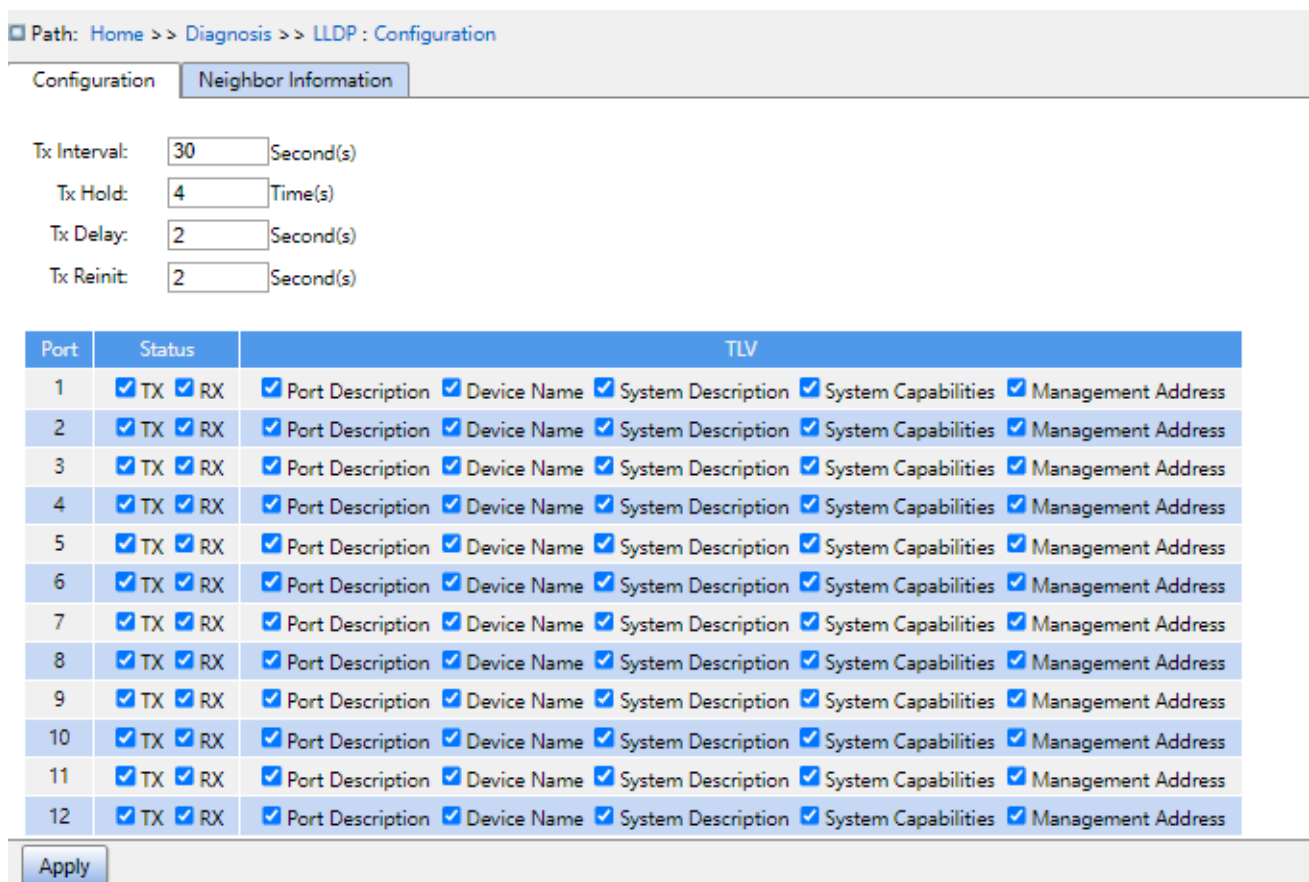

Figure 238 Configure LLDP

#### Tx Interval

Configuration range: 5~32768s

Default configuration: 30s

Function: Configutr the time interval for sending LLDP packets.

#### Tx Hold

Configuration range: 2~10 times

Default configuration: 4 times

Function: Set the number of Tx holding times. Effective duration of an LLDP packet = Tx Interval x Tx Hold.

### **Tx Delay**

Configuration range: 1~8192s

Default configuration: 2s

Function: Set the transmission interval between a new LLDP packet and the previous LLDP packet after configuration information is changed. The value of Tx Delay cannot be larger than 1/4 of the value of Tx Interval.

### **Tx Re-initialization**

Configuration range: 1~10s

Default configuration: 2s

Function: After LLDP is disabled on a port or a switch is restarted, the switch sends an LLDP shutdown frame to a neighboring node to announce that the previous LLDP packet is invalid. Tx re-initialization refers to the interval between transmission of the LLDP shutdown frame and re-initialization of an LLDP packet.

### **Status**

Configuration options: Disable/TX/RX/TX&RX

Default configuration: TX&RX

Function: Configure the LLDP packet mode. Enabling TX&RX mode means that the switch sends both LLDP packets and also receives and identifies LLDP packets; Disable mode means that the switch neither sends LLDP packets nor receives LLDP packets; Only the Rx mode means that the switch only receives and recognizes LLDP packets and does not send LLDP packets; Only the Tx mode means that the switch only sends LLDP packets and does not receive LLDP packets.

### **Port Description**

Configuration options: Enabled/Disabled

Default configuration: Enabled

Function: Enable indicates LLDP packets will carry port description.

### **Device Name**

Configuration options: Enabled/Disabled

Default configuration: Enabled

Function: Enable indicates LLDP packets will carry system name.

**System Description**

Configuration options: Enabled/Disabled

Default configuration: Enabled

Function: Enable indicates LLDP packets will carry system description.

**Sys Capability**

Configuration options: Enabled/Disabled

Default configuration: Enabled

Function: Enable indicates LLDP packets will carry system capability.

**Management Address**

Configuration options: Enabled/Disabled

Default configuration: Enabled

Function: Enable indicates LLDP packets will carry management address.

2. View LLDP information, as shown below.

Path: Home >> Diagnosis >> LLDP : Neighbor Information

Configuration Neighbor Information

Local Port	Neighbor						
	Chassis ID	Port	Port Description	Device Name	System Description	System Capabilities	Management Address
FastEthernet 1/4	00-01-C1-00-00-01	Port_8	FastEthernet 1/8	A8012-220	R0003 Jan 3 2017 09:27:10	Bridge(+)	100.1.1.220

Figure 239 View LLDP Information



**Caution:**

To display LLDP information, LLDP must be enabled on the two connected devices.

**9.4 Trace Route**

Trace route allows us to see the route of IP data packets from one host to another.

1. Configure Trace route, as shown below.

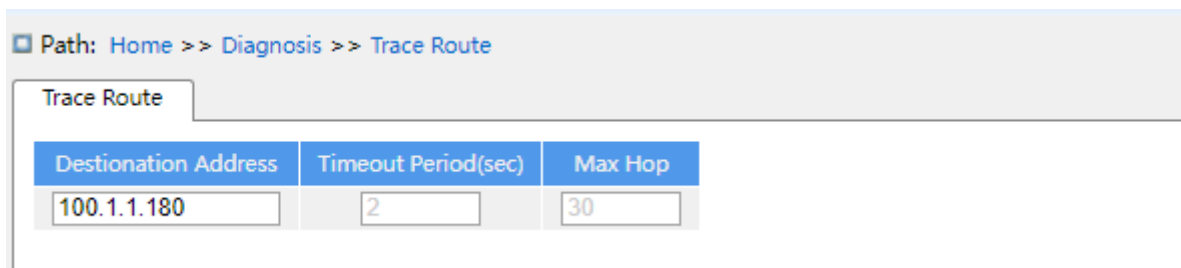

Figure 240 Configure Traceroute

**Destination address**

Configuration format: A.B.C.D

Function: Configure IP address of destination device.

**Timeout Period**

Configuration range: 1~10s

Default configuration: 2s

Function: Configure timeout period, If the sending end does not receive a response message from the receiving end within this time, the communication failed.

**Max Hop**

Default Configuration range: 1~255

Default configuration: 30

Function: Test the number of gateways that data packets pass from the sending device to the destination device.

2. View Traceroute command output information, as shown below.

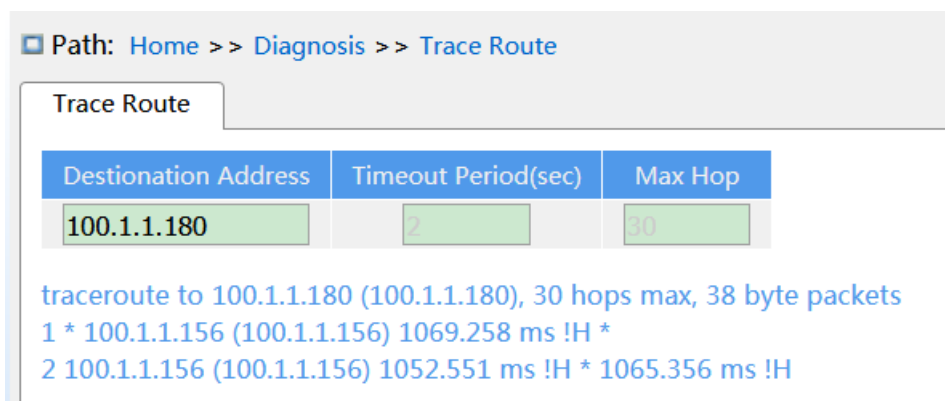

Figure 241 View output



## 9.5 Ping

Users can run the ping command to check whether the device of a specified address is reachable and whether the network connection is faulty during routine system maintenance.

1. Configure ping command, as shown below.

The screenshot shows a web-based configuration interface for the Ping command. At the top, the breadcrumb path is 'Home >> Diagnosis >> Ping'. Below this, there is a 'Ping' tab. The main configuration area consists of a table with four columns: 'Server Address', 'Ping Length', 'Ping Count', and 'Ping Interval'. Each column has a corresponding input field. The values entered in the fields are: '100.1.1.180' for Server Address, '56' for Ping Length, '5' for Ping Count, and '1' for Ping Interval.

Server Address	Ping Length	Ping Count	Ping Interval
100.1.1.180	56	5	1

Figure 242 Configure Ping Command

### Server Address

Format: A.B.C.D

Description: Input the IP address of the destinate device.

### Ping Length

Configuration range: 2~1452 bytes

Default configuration: 56 bytes

Function: Specify the length of an ICMP request (excluding the IP and ICMP packet header) for transmission.

### Ping Count

Configuration range: 1~60

Default configuration: 5

Function: Specify the number of times for sending an ICMP request.

### Ping Interval

Configuration range: 1~30s

Default configuration: 1s

Function: Specify the interval for sending an ICMP request.

2. View ping output, as shown below.

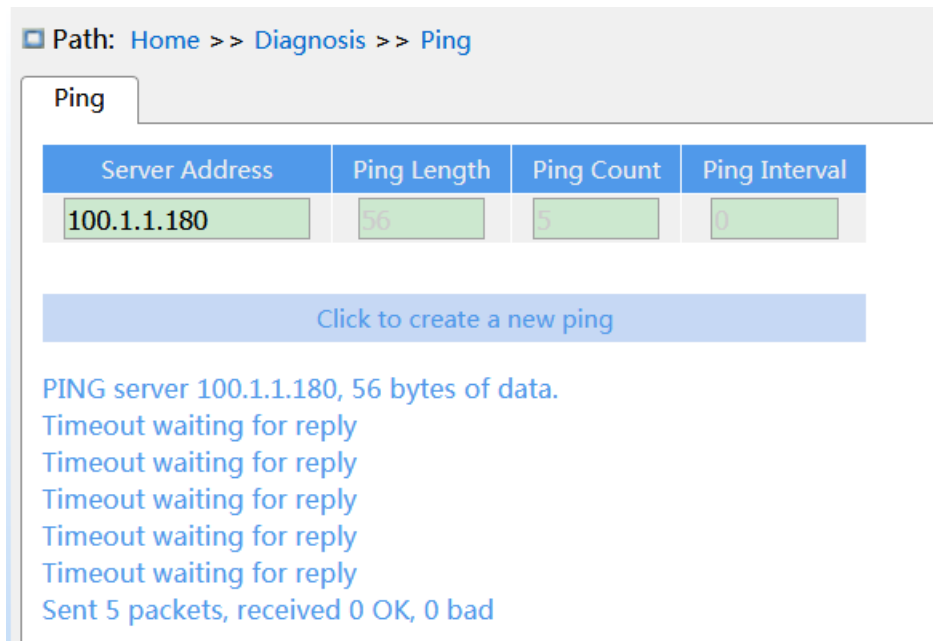

Figure 243 View Ping Output

The output of the ping command includes response of the destination device to each ICMP request packet and packet statistics collected during the running of the ping command.

## 9.6 IP Source Guard

### 9.6.1 Introduce

Through the binding function of IP Source Guard, the messages forwarded by the port can be filtered to prevent the illegal messages pass through the port, thus it limits the illegal use of network resource (such as illegal host counterfeit legitimate user IP access the network), improving the security of the port.

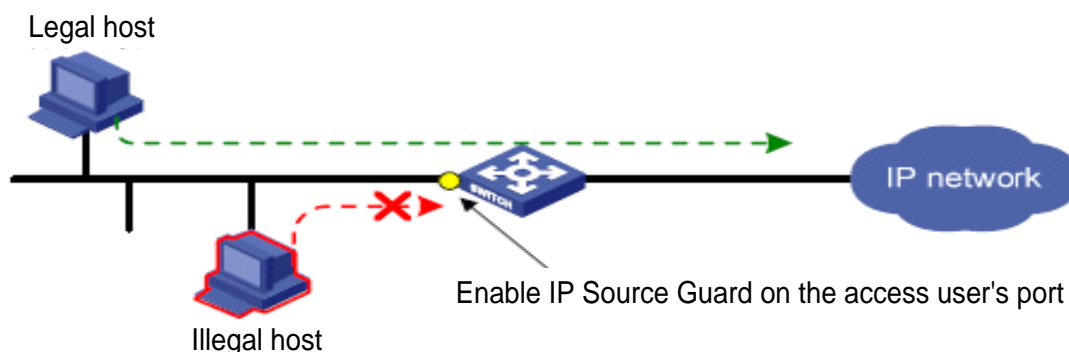

Figure 244 IP Source Guard function diagram

### 9.6.2 Principle

The configured port with this feature search IP Source Guard binding table after receiving the message, If the feature item in the message matches the recorded feature item in the binding table, the port forwards the message, otherwise, drop the message. Binding function is for the port, one port is binding, only this port is restricted, the other ports are not affected by the binding.

The feature item of IP Source Guard includes: source IP address, source MAC address, and VLAN tag. And it supports the combination of ports with the following features item (binding table item in short):

- IP、 MAC、 IP+MAC
- IP+VLAN、 MAC+VLAN、 IP+MAC+VLAN

The supported type of binding table items by the port is related to the type of the device, depending on the actual situation of the device.

IP Source Guard is divided into static binding and dynamic binding according to the generation mode of binding table items:

- **Static binding:** By manually configuring binding table items to control the port, it is suitable for the case that the number of hosts in the local network is less or a host need to bind separately.
- **Dynamic binding:** The port control function is accomplished by automatically obtaining the binding table items of DHCP Snooping or DHCP Relay, which is suitable for many hosts in local area network and using DHCP to configure dynamic hosts, it can effectively prevent IP address conflicts and embezzlement. The principle is that whenever DHCP assigns a table item to a user, the dynamic binding function adds a binding table item accordingly to allow the user to access the network. If a user sets the IP address privately, the user will not be able to access the network because it does not trigger the DHCP assignment table item, and the dynamic binding function does not add the corresponding access permission rule.

### 8.6.3 Web Configuration

1. Enable IP Source Guard, as shown below.

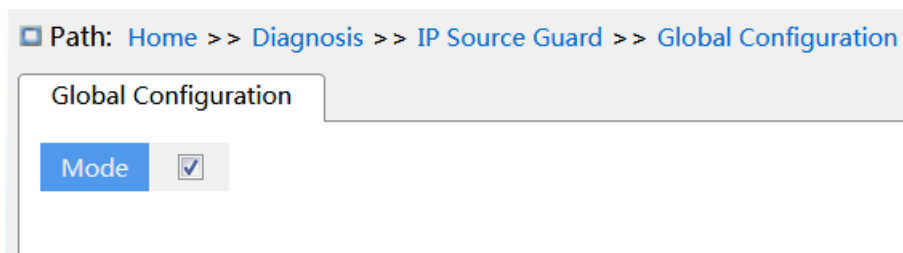

Figure 245 Configure IP Source Guard

**Mode**

Configuration options: Enable/disable

Default configuration: Disable

Function: Whether enable global IP Source Guard.

2. Configure Port IP Source Guard, as shown below.



Figure 246 Configure Port IP Source Guard

**Enable**

Configuration options: Enable/disable

Default configuration: Disable

Function: Whether enable port IP Source Guard.

3. Static Binding Configuration, as shown below.

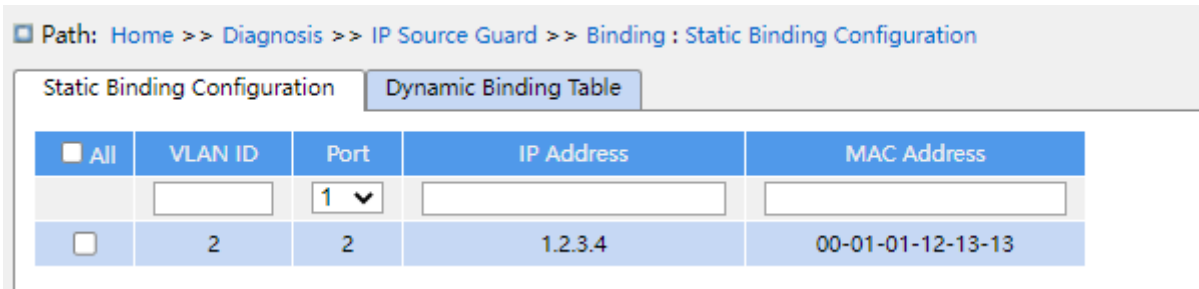

Figure 247 Static Binding Configuration

**VLAN ID**

Configuration options: All VLAN ID

Function: configure VLAN ID of static binding table.

**Port**

Function: Select member port of the static binding table.

**IP address**

Configuration format: A.B.C.D

Function: configure IP address of static binding table.

**MAC address**

Configuration format: HH-HH-HH-HH-HH-HH 或 HH:HH:HH:HH:HH:HH (H is a hexadecimal number)

Function: Configure MAC address of static binding table, only configure as unicast MAC address.

4. View Dynamic Binding table, as shown below.

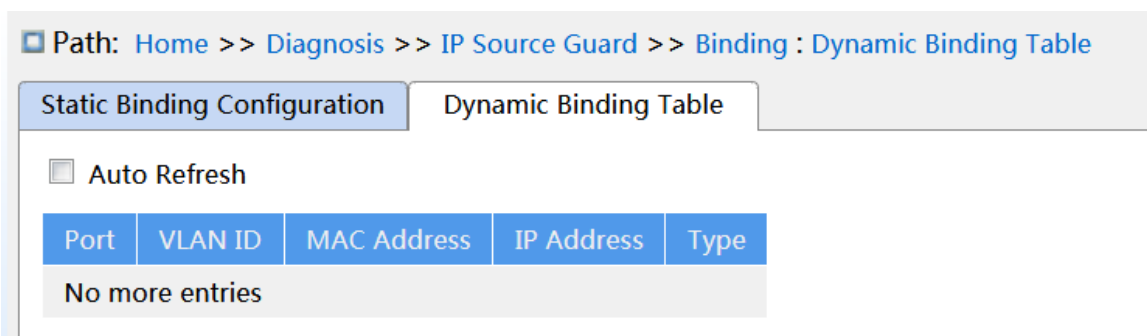

Figure 248 View Dynamic Binding table

**Type**

Display options: Relay/Snooping

Description: The dynamic binding table is generated by DHCP Relay and DHCP Snooping devices, the table items of Relay type is generated after enable global IP Source Guard,

table items of type snooping are generated after both the global and ports that connect to the DHCP client enable IP Source Guard.

## 8.6.4 Typical Configuration Example

### 1. Relay type IP Source Guard table items

As shown in Figure 249, Switch A as the DHCP server, switch B as the DHCP relay, switch C as the DHCP client, and 1 port of switch A connected to the 1 port of switch B, 2 port of switch B connect to 2 port of switch C. DHCP server is not in the same LAN as the DHCP client. After the relay device enable IP Source Guard, the client dynamically obtains the IP address and other network parameters with DHCP mode through DHCP relay. The relay device forms IP Source Guard table items.



Figure 249 DHCP typical configuration example

#### ➤ Switch A configuration:

1. Create VLAN1 and configure IP address: 100.1.1.156;
2. Open the DHCP server state in VLAN 1, as shown in Figure 180;
3. Create address pool pool-33, as shown in Figure 181;
4. Select address pool type as Network; IP address: 33.1.1.6; Mark: 255.0.0.0, as shown in Figure 182;

#### ➤ Switch B configuration:

1. Create VLAN1 and configure IP address: 100.1.1.180;
2. Create VLAN33 and configure IP address: 33.1.1.2;
3. Enable DHCP relay, as shown in Figure 195;
4. Configure Server IP address: 100.1.1.156, as shown in Figure 195;
5. Enable global IP Source Guard, as shown in Figure 245;

#### ➤ Switch C configuration:

1. Create VLAN33 and enable DHCP Client;

2. Switch A assigns address 33.0.0.1 to Switch C;

After the switch C gets the address, the IP Source Guard table can be viewed on the switch B, as shown in Figure 248.

## 2. Snooping type IP Source Guard table items

As shown below, Switch A as the DHCP server, switch B as the DHCP Snooping, switch C as the DHCP client, and 1 port of switch A connected to the 1 port of switch B, 2 port of switch B connect to 2 port of switch C. DHCP server is not in the same LAN as the DHCP client. After Snooping device enable IP Source Guard, the client dynamically obtains the IP address and other network parameters with DHCP mode through DHCP Snooping. The relay device forms IP Source Guard table items.



Figure 250 DHCP typical configuration example

➤ Switch A configuration:

1. Create VLAN1 and configure IP address: 100.1.1.156;
2. Open the DHCP server state in VLAN 1, as shown in Figure 180;
3. Create address pool pool-1;
4. Select address pool type as Network; IP address: 33.1.1.6; Mark: 255.0.0.0;

➤ Switch B configuration:

1. Create VLAN1 and configure IP address: 100.1.1.180;
2. Enable DHCP Snooping;
3. Configure 1 port as trust port, as shown in Figure 191;
4. Enable global IP Source Guard, as shown in Figure 245;
5. Port 2 enable IP Source Guard, as shown in Figure 246;

➤ Switch C configuration:

1. Create VLAN1 and enable DHCP Client;
2. Switch A assigns address 100.0.0.1 to Switch C;

After the switch C gets the address, the IP Source Guard table can be viewed on the switch B.

## 9.7 DDM

### 9.7.1 Introduce

Digital diagnosis is an effective method for monitoring important performance parameters of optical modules. The parameters it monitors include: transmitted optical power, received optical power, temperature, operating voltage, bias current, and their alarm information. Through the digital diagnosis function of the optical module, the network management unit can access the optical module through the two-wire serial bus, and monitor the temperature, working voltage, bias current, transmitted optical power and received optical power of the module in real time.

### 9.7.2 Web Configuration

#### 1. Basic Information

According to the path below, click to view the basic information of the optical module inserted into the device, as shown in the following figure.

Interface	TransLen(Media Type)	Nominal Speed
10	550m(MMF_50UM_OM2) 550m(MMF_50UM_OM3)	1000BASE_SX
11	2000m(MMF_50UM_OM2)	100BASE_FX
12	10000m(SMF_H) 10Km(SMF_K)	1000BASE_LX

Figure 251 Basic information of optical module

#### 2. Power Information

According to the following path, click to view the optical power information of the optical module, as shown in the figure below.



Path: Home >> Diagnosis >> DDM : Power Information

Interface	tx_power_low(dBm)	tx_power_cur(dBm)	tx_power_high(dBm)	rx_power_low(dBm)	rx_power_cur(dBm)	rx_power_high(dBm)
10	-11.0	-4.3	-1.0	-21.0	-40.5	2.0
11	-16.0	-11.7	-7.0	-30.0	-40.5	-7.0
12	-11.0	-7.3	-1.0	-30.0	-40.5	0.0

Figure 252 Basic information of optical power

Path: Home >> Diagnosis >> DDM : Power Information

Interface	tx_power_low(dBm)	tx_power_cur(dBm)	tx_power_high(dBm)	rx_power_low(dBm)	rx_power_cur(dBm)	rx_power_high(dBm)
10	-11.0	-4.3	-1.0	-21.0	-40.5	2.0
11	-16.0	-11.7	-7.0	-30.0	-40.5	-7.0
12	-11.0	-7.3	-1.0	-30.0	-40.5	0.0

Figure 252 Basic information of optical power

Path: Home >> Diagnosis >> DDM : Power Information

Interface	tx_power_low(dBm)	tx_power_cur(dBm)	tx_power_high(dBm)	rx_power_low(dBm)	rx_power_cur(dBm)	rx_power_high(dBm)
10	-11.0	-4.3	-1.0	-21.0	-40.5	2.0
11	-16.0	-11.7	-7.0	-30.0	-40.5	-7.0
12	-11.0	-7.3	-1.0	-30.0	-40.5	0.0

Figure 252 Basic information of optical power

## Appendix: Acronyms

<b>Acronym</b>	<b>Full Spelling</b>
ACE	Access Control Entry
ACL	Access Control List
ARP	Address Resolution Protocol
BootP	Bootstrap Protocol
BPDU	Bridge Protocol Data Unit
CIST	Common and Internal Spanning Tree
CLI	Command Line Interface
CoS	Class of Service
CST	Common Spanning Tree
DHCP	Dynamic Host Configuration Protocol
DHP	Dual Homing Protocol
DNS	Domain Name System
DRP	Distributed Redundancy Protocol
DSCP	Differentiated Services CodePoint
DST	Daylight Saving Time
EAPOL	Extensible Authentication Protocol over LAN
GARP	Generic Attribute Registration Protocol
GMRP	GARP Multicast Registration Protocol
GVRP	GARP VLAN Registration Protocol

Path: Home >> Diagnosis >> DDM : Power Information

Interface	tx_power_low(dBm)	tx_power_cur(dBm)	tx_power_high(dBm)	rx_power_low(dBm)	rx_power_cur(dBm)	rx_power_high(dBm)
10	-11.0	-4.3	-1.0	-21.0	-40.5	2.0
11	-16.0	-11.7	-7.0	-30.0	-40.5	-7.0
12	-11.0	-7.3	-1.0	-30.0	-40.5	0.0

Figure 252 Basic information of optical power

HTTP	Hyper Text Transfer Protocol
ICMP	Internet Control Message Protocol
IGMP	Internet Group Management Protocol
IGMP Snooping	Internet Group Management Protocol Snooping
IST	Internal Spanning Tree
LACP	Link Aggregation Control Protocol
LACPDU	Link Aggregation Control Protocol Data Unit
LLDP	Link Layer Discovery Protocol
LLDPDU	Link Layer Discovery Protocol Data Unit
MIB	Management Information Base
MSTI	Multiple Spanning Tree Instance
MSTP	Multiple Spanning Tree Protocol
NAS	Network Access Server
NetBIOS	Network Basic Input/Output System
NMS	Network Management Station
NTP	Network Time Protocol
OID	Object Identifier
PCP	Priority Code Point
PVLAN	Private VLAN
QCL	QoS Control List
QoS	Quality of Service
RADIUS	Remote Authentication Dial-In User Service
RMON	Remote Network Monitoring

Path: Home >> Diagnosis >> DDM : Power Information

Interface	tx_power_low(dBm)	tx_power_cur(dBm)	tx_power_high(dBm)	rx_power_low(dBm)	rx_power_cur(dBm)	rx_power_high(dBm)
10	-11.0	-4.3	-1.0	-21.0	-40.5	2.0
11	-16.0	-11.7	-7.0	-30.0	-40.5	-7.0
12	-11.0	-7.3	-1.0	-30.0	-40.5	0.0

Figure 252 Basic information of optical power

RSTP	Rapid Spanning Tree Protocol
SFTP	Secure File Transfer Protocol
SNMP	Simple Network Management Protocol
SNTP	Simple Network Time Protocol
SP	Strict Priority
SSH	Secure Shell
SSL	Secure Sockets Layer
SSM	Source Specific Multicast
STP	Spanning Tree Protocol
TACACS+	Terminal Access Controller Access Control System
TCP	Transmission Control Protocol
UDP	User Datagram Protocol
USM	User-Based Security Model
VLAN	Virtual Local Area Network
WINS	Windows Internet Naming Service
WRR	Weighted Round Robin